

E4990A Impedance Analyzer Help

Table of Contents

Using this Help	3
Opening E4990A Help.....	3
Context Sensitive Help	3
Closing E4990A Help	3
Viewing E4990A Help on your PC	4
Switching between E4990A Help and Measurement View	4
Navigating E4990A Help	4
Navigation bar	4
Toolbar	4
Quick Access	5
Conventions used in E4990A Help	5
Precautions	7
Precautions	7
Safety	7
Safety Summary.....	7
Safety Symbols.....	8
Notices	9
Certification	9
Documentation Warranty	9
Exclusive Remedies.....	10
Assistance	10
Sample Program.....	10
Installing Software.....	11
Updating Pre-Installed Software.....	11
Installing User Application Software	11
Protecting the E4990A	11
Read the warning labels and specifications.....	11
Do NOT Plug off Power Cable during Shutdown Process	11
Do NOT Modify or Reconfigure the Operating System	11
Install Antivirus Protection	12
Install Windows Critical Updates	12

Table of Contents

Precaution for Use of Storage	12
Precaution for input connector and cable.....	12
Precautions for Electrostatic Discharge (ESD)	13
Maintain working environment condition	13
Precautions for transportation.....	13
Check for Proper Ventilation	13
Precautions for Proper Grounding.....	13
Before Contacting us.....	14
The system starts up, but the normal measurement screen does not appear.....	14
Unstable Operation	14
Quick Start	15
Overview	15
Overview	15
Front Panel: Names and Functions of Parts.....	15
Rear Panel: Names and Functions of Parts	24
Screen Area	28
Measurement Example	42
Measurement Example	42
Required Equipment	42
Preparing for a Measurement.....	42
Specifying Measurement Conditions	43
Fixture Compensation.....	45
Carrying Out Measurement and Viewing Results	47
Results of Analysis	51
Softkey Shortcuts	52
Measurement.....	55
Measurement	55
Preparation of Measurement Accessories	55
Preparation of Measurement Accessories.....	55
Selecting Accessories for Measurement.....	55
Connecting the Accessories	59
Adapter Setting	59

E4990A Impedance Analyzer Help

Adapter Selection.....	63
Adapter Setup	63
Setting Measurement Conditions.....	71
Setting Measurement Conditions.....	71
Initializing Parameters.....	72
Setting Channels and Traces	72
Selecting Sweep Parameter	79
Setting Source.....	90
Setting Trigger	93
Calibration	100
Calibration	100
Selecting Appropriate Calibration Method	100
A. Direct Connection Type Test Fixture	104
B. Calibration for Four-Terminal Pair, 1-m Extension	105
C. Calibration for Four-Terminal Pair, 2-m Extension	107
D. Exclusive Fixture.....	109
E. 42942A, 7-mm Port Extension	111
F. 42941A, Probe Adapter	113
G. 42941A 3.5mm Port Extension	115
User Calibration	117
Port Extension Compensation	119
Fixture Compensation.....	120
Selecting Calibration/Compensation Frequency Points.....	122
Setting Up the Display of Measurement Results	124
Setting Up the Display of Measurement Results	124
Selecting the Measurement Parameters	124
Selecting the Graph Axis Format	127
Scaling Trace.....	128
Trace-based Comparison and Calculation	130
Monitoring Source Signal Level	133
Setting for Phase	134
Setting Windows Display.....	135
Analysis and Processing of Result.....	142

Analysis and Processing of Result	142
Analyzing Data on the Trace Using the Marker	143
Searching for Positions that Match Specified Criteria.....	151
Analyze Trace Bandwidth	160
Reading the marker position time or relaxation time.....	164
Analyzing the Equivalent Circuit and Simulate the Frequency Characteristics.....	164
Calculating the Mean Value, Standard Deviation, and p-p of the Trace	167
Calculating Several Traces (Equation Editor)	169
Making Pass/Fail Evaluation (Limit Test)	175
Outputting Data.....	186
Outputting Data.....	186
Saving and Recalling Instrument State	186
Saving/Recalling Instrument State for Each Channel into/from Memory	190
Saving Trace Data to a File	191
Saving the Screen Image to a File.....	195
Printing Displayed Screen	195
Setting Control Functions	199
Setting Control Functions.....	199
Setting the GPIB.....	199
Setting talker/listener GPIB address of E4990A.....	199
Setting system controller (USB/GPIB interface)	199
Remote Control Using HTTP (Web Browser)	201
Enabling Web Server	201
Browser Web Control.....	202
Turning on/off the Date/Time Display	202
Turning off the LCD Screen Backlight	203
Turning OFF the LCD Screen Backlight	203
Calibration of the Touch Screen.....	203
Exit/Restart E4990A Measurement Application.....	204
Checking the product information	204
Overview	204

E4990A Impedance Analyzer Help

Procedure	205
Activating Software Option.....	205
Activating Option	205
Backing Up License Key File	205
Locking the Front Keys, Keyboard, and/or Mouse (Touch Screen)	206
Locking the Front Keys, Keyboard, and/or Mouse	206
Setting the Beeper (Built-in Speaker)	206
Setting the Operation Complete Beeper	207
Setting the Warning Beeper	207
Setting the Preset Function	207
Showing/hiding the confirmation buttons when presetting.....	207
Setting the user preset function.....	208
Saving a user-preset instrument state	208
Using Windows.....	209
Using Windows	209
Windows Consideration.....	209
Storage	209
Using USB.....	210
Plug & Play Stability and Security.....	210
LAN Connections.....	210
Single and Double Click option.....	210
Printing.....	210
Change Date/Time Settings.....	211
User Account and Password	212
Account Settings.....	212
To Change Password	213
To Add and Remove User	213
On-Screen Keyboard	214
On-Screen Keyboard overview	214
To open Windows On-Screen Keyboard.....	215
Configuring Network	215
Enabling/Disabling Network.....	215
Check/Reset IP Address	216

Table of Contents

Setting IP address.....	216
Checking Computer Name.....	217
Windows Firewall	217
To Turn Windows Firewall ON or OFF	217
Enabling/Disabling USB Storage	218
Local Group Policy Editor.....	219
Enabling & Disabling USB Storage.....	220
Connecting External Accessories	222
Connecting a Printer.....	223
Connecting a Mouse/Keyboard.....	223
Connecting a Monitor.....	223
Product Information	225
Product Information	225
Options for E4990A	225
Frequency Options	225
Time Base Options	226
Software Option.....	226
Accessory Options.....	226
Calibration Option	226
System Rack Options.....	226
Documentations for E4990A.....	227
Manuals	227
Sales Literature	227
Specifications	228
Customer Contacts	228
ErrorMessage	228
Error and Warning Messages	228
Warning Messages	228
Error Messages	230
Troubleshooting.....	246
Troubleshooting during Startup.....	247
Troubleshooting during Operation	247
Troubleshooting for External Devices.....	249

E4990A Impedance Analyzer Help

Measurement Accessories	250
Maintenance.....	250
Maintenance	250
Cautions Applicable to Requesting Repair, Replacement, Regular Calibration, etc.	251
Cleaning this Instrument.....	252
Replacement of Parts with Limited Service Life	253
System Recovery	254
Updating Firmware.....	254
Service Functions	256
Removing Log Data	256
Programming	257
Programming	257
Remote Control	257
Overview	257
Setting Measurement Condition	272
Preparing for Accurate Measurement	276
Starting a Measurement (Trigger) and Detecting the Completion of a Measurement	281
Reading Writing Measurement Data.....	289
Processing Measurement Results.....	300
Saving/Recalling a Measurement Result/Measurement Setup.....	310
Communication with External Equipment (Using I/O Ports)	315
Status Reporting System	329
Using Macro	340
Command Reference	347
Command Reference	347
Notational Conventions.....	348
ABORT.....	350
CALCULATE	350
CONTROL.....	436
DISPLAY	446
FORM	490

Table of Contents

HCOPY.....	494
IEEE.....	497
INIT.....	506
LXI.....	507
MMEMORY.....	508
SENSE.....	527
SERVICE.....	585
SOURCE.....	601
STATUS.....	632
SYSTEM.....	651
TRIGGER.....	665
Index.....	673



E4990A Impedance Analyzer

Welcome



- [Using this Help](#) (Read me first)
- Revision History
- [Precautions](#)
- Quick Start
- [Measurement](#)
- [Setting Control Functions](#)
- [Using Windows](#)
- [Product Information](#)
- [Programming](#)

The E4990A help provides an easy access to the information related to the use of Keysight E4990A Impedance Analyzer. Pressing **Help** key on the front panel displays the topic related to the selected softkey.

You can navigate this help system through the navigation tools provided in the left or you can directly access the chapters:

E4990A Firmware Revision	A.02.1x
Help Edition No.	2.00
Help Revision Date	May 26,2015

© Keysight Technologies, 2014-2015

Using this Help

This help provides the user and programming documentation in an searchable electronic format for the E4990A Network Analyzer. This section describes the usage of this help system.

- [Opening E4990A Help](#)
- [Context Sensitive Help](#)
- [Closing E4990A Help](#)
- [Viewing E4990A Help on PC](#)
- [Switching between E4990A Help and Measurement View](#)
- [Navigating E4990A Help](#)
- [Conventions used in E4990A Help](#)

Opening E4990A Help

This help system is provided in Microsoft Compressed HTML Help format (.chm). This help can be also be viewed on a normal PC.

To open E4990A help, use either of the following methods:

- By pressing the **Help** key located in the **ENTRY** Block.
- By pressing the **F1** key on a keyboard attached with the E4990A.
- By double-clicking **E4990A_Help.chm** (located in **C:\Program Files (x86)\Agilent\E4990\Help**).

Context Sensitive Help

Context sensitive help is a great feature of the E4990A help. It allows you to get information about the selected softkey by pressing the **Help** key in the E4990A or by pressing **F1** in a keyboard attached to the E4990A or by clicking the help button in a dialog box. It provides information relevant to the task that needs to be accomplished and reduces the time to search relevant information required to complete a task.

Closing E4990A Help

To close the E4990A help, click , located on the top right of the E4990A help viewer.

Viewing E4990A Help on your PC

The E4990A help can be opened and viewed on a normal PC. The help file (**E4990A_Help.chm**) is located in the E4990A Network Analyzer storage at **C:\Program Files (x86)\Keysight\E4990\Help**. Copy it to the local storage drive on your PC, then double-click it to view.

A web help is also available at <http://www.keysight.com/find/e4990A-manual>.

NOTE

Do not locate E4990A_Help.chm in a network drive because the topics is not displayed.

Switching between E4990A Help and Measurement View

The **Foc** Key, located in the **Entry** Block, can be used to switch between the E4990A Measurement View and Help View.

Navigating E4990A Help

The E4990A help system provides several ways to navigate through the information related to the use of E4990A Network Analyzer. These sections describe the navigation system of the E4990A help which consists of:

- [Navigation bar](#)
- [Quick Access](#)
- [Toolbar](#)

Navigation bar

Navigation bar comprises of tabs related to **Contents**, **Index**, **Search** and **Glossary**. The **Contents** tab contains the main navigational structure of the E4990A help. The **Glossary** tab contains explanation of the terms significant to the E4990A Network Analyzer. The **Index** tab is an additional tool that can be used to navigate different topics according to their alphabetical listing. The **Search** tab can be used to search any term/phrase used in the E4990A online Help.

Toolbar



The toolbar can be used to navigate through the help. The **Home** option can be used to return to the home page of the E4990A help which contains Quick Access to chapters in the help. The **Back** and **Forward** options can be used to toggle between visited topics. The **Print** option can be used to print the selected, or all the topics of the E4990A help.

Quick Access

Quick access, located on the **Home Page** of the E4990A help, is a convenient and quick way to access the contents of the E4990A help.

Conventions used in E4990A Help

Naming Conventions Used in this Help

Convention	Description	Example
File Name/Path	File names and path associated with them as displayed as Bold in Arial with 12 pt size.	C:\Documents and Settings\test.txt example2.xls
Hard keys	Hard Keys (Keys located on the Front panel of E4990A) are displayed in Blue color, Bold in Verdana with 12 pt size.	Trace Max Foc Marker
Softkeys	Also known as menu keys, are the names of menu that appear in the Firmware (Software) of E4990A and are displayed as Bold in Arial with 12 pt size.	Auto Scale All Allocate Channels
BLOCK Names	E4990A Front Panel is divided into 7 blocks. These blocks are displayed in ALL CAPS, Green Color, Bold in Arial with 12 pt size, followed by the word 'Block'.	RESPONSE Block ENTRY Block STIMULUS Block
Note	This Note sign denotes important information. It calls attention to a condition that is essential for the user to understand.	 This is a Note.
Caution	This Caution sign denotes a hazard. It calls attention to a procedure, practice, or condition that, if not correctly performed or adhered to, could	 This is a Caution.

	<p>result in damage to or destruction of part or all of the instrument.</p>	
<p>Warning</p>	<p>This warning sign denotes a hazard. It calls attention to a procedure, practice, or condition that, if not correctly performed or adhered to, could result in injury or death to personnel.</p>	<p>WARNING Thi s is a Warning .</p>

Precautions

Precautions

- [Safety](#)
- [Notices](#)
- [Installing Software](#)
- [Protecting the E4990A](#)
- [Before Contacting us](#)

Safety

Safety Summary

The following general safety precautions must be observed during all phases of operation, service, and repair of this instrument. Failure to comply with these precautions or with specific WARNINGS elsewhere in this manual may impair the protection provided by the equipment. Such noncompliance would also violate safety standards of design, manufacture, and intended use of the instrument. Keysight Technologies assumes no liability for the customer's failure to comply with these precautions.

NOTE

The E4990A complies with INSTALLATION CATEGORY II as well as POLLUTION DEGREE 2 in IEC61010-1. The E4990A is an INDOOR USE product.

NOTE

The LEDs in the E4990A are Class 1 in accordance with IEC60825-1, CLASS 1 LED PRODUCT

- Ground the Instrument

To avoid electric shock, the instrument chassis and cabinet must be grounded with the supplied power cable's grounding prong.

- DO NOT Operate in an Explosive Atmosphere

Do not operate the instrument in the presence of inflammable gasses or fumes. Operation of any electrical instrument in such an environment clearly constitutes a safety hazard.

- Keep Away from Live Circuits

Operators must not remove instrument covers. Component

replacement and internal adjustments must be made by qualified maintenance personnel. Do not replace components with the power cable connected. Under certain conditions, dangerous voltage levels may remain even after the power cable has been disconnected. To avoid injuries, always disconnect the power and discharge circuits before touching them.

- DO NOT Service or Adjust the Instrument Alone

Do not attempt internal service or adjustment unless another person, capable of rendering first aid and resuscitation, is present.

- DO NOT Substitute Parts or Modify the Instrument

To avoid the danger of introducing additional hazards, do not install substitute parts or perform unauthorized modifications to the instrument. Return the instrument to an Keysight Technologies Sales and Service Office for service and repair to ensure that safety features are maintained in operational condition.

- Dangerous Procedure Warnings

Warnings, such as the example below, precede potentially dangerous procedures throughout this manual. Instructions contained in the warnings must be followed.

WARNING Dangerous voltage levels, capable of causing death, are present in this instrument. Use extreme caution when handling, testing, and adjusting this instrument.

Safety Symbols



Instruction Manual symbol: the product is marked with this symbol when it is necessary for the user to refer to the instrument manual.



Alternating current.



Direct current.



[On \(Supply\).](#)



[Off \(Supply\).](#)



A chassis terminal; a connection to the instrument's chassis, which includes all exposed metal structure.



[Stand-by.](#)

Notices

The information contained in this document is subject to change without notice.

This document contains proprietary information that is protected by copyright. All rights are reserved. No part of this document may be photocopied, reproduced, or translated to another language without the prior written consent of Keysight Technologies.

Microsoft®, MS-DOS®, Windows®, Visual C++®, Visual Basic®, VBA® and Excel® are registered trademarks of Microsoft Corporation.

Java® is registered trademark of Sun Microsystems Corporation.

© Copyright 2015 Keysight Technologies. All rights reserved.

Certification

Keysight Technologies certifies that this product met its published specifications at the time of shipment from the factory. Keysight Technologies further certifies that its calibration measurements are traceable to the United States National Institute of Standards and Technology, to the extent allowed by the Institution's calibration facility or by the calibration facilities of other International Standards Organization members.

Documentation Warranty

The material contained in this document is provided "as is," and is subject to being changed, without notice, in future editions. Further, to the maximum extent permitted by applicable law, Keysight disclaims all warranties, either express or implied with regard to this manual and any information contained herein, including but not limited to the implied warranties of merchantability and fitness for a particular purpose. Keysight shall not be liable for errors or for incidental or consequential damages in connection with the furnishing, use, or performance of this document or

any information contained herein. Should Keysight and the user have a separate written agreement with warranty terms covering the material in this document that conflict with these terms, the warranty terms in the separate agreement will control.

Exclusive Remedies

The remedies provided herein are Buyer's sole and exclusive remedies. Keysight Technologies shall not be liable for any direct, indirect, special, incidental, or consequential damages, whether based on contract, tort, or any other legal theory.

Assistance

Product maintenance agreements and other customer assistance agreements are available for Keysight Technologies products.

For any assistance, contact your nearest [Keysight Technologies Sales and Service Office](#).

Sample Program

The customer shall have the personal, non-transferable rights to use, copy, or modify SAMPLE PROGRAMS in this manual for the customer's internal operations. The customer shall use the SAMPLE PROGRAMS solely and exclusively for their own purposes and shall not license, lease, market, or distribute the SAMPLE PROGRAMS or modification of any part thereof.

Keysight Technologies shall not be liable for the quality, performance, or behavior of the SAMPLE PROGRAMS. Keysight Technologies especially disclaims any responsibility for the operation of the SAMPLE PROGRAMS to be uninterrupted or error-free. The SAMPLE PROGRAMS are provided AS IS.

Keysight TECHNOLOGIES DISCLAIMS ANY IMPLIED WARRANTY OF MERCHANTABILITY AND FITNESS FOR A PARTICULAR PURPOSE.

Keysight Technologies shall not be liable for any infringement of any patent, trademark, copyright, or other proprietary right by the SAMPLE PROGRAMS or their use. Keysight Technologies does not warrant that the SAMPLE PROGRAMS are free from infringements of such rights of third parties. However, Keysight Technologies will not knowingly infringe or deliver software that infringes the patent, trademark, copyright, or other proprietary right of a third party.

Useful sample program library are available at <http://www.keysight.com/find/e4990a>

Installing Software

Updating Pre-Installed Software

Do not update pre-installed software in except when Keysight recommends to do so.

Installing User Application Software

Users can install commercial application software for Windows on the E4990A at their own risk. Some application software may affect the measurement performance, especially measurement speed.

Protecting the E4990A

To protect your E4990A, follow the instructions below:

Read the warning labels and specifications

Do not exceed the values provided in the specifications guide or as indicated by the yellow warning labels on the front panel of the E4990A. Refer to the [specifications](#) for the conditions required to meet the listed specifications. There will be information regarding E4990A settings, and calibration requirements.

Do NOT Plug off Power Cable during Shutdown Process

Do Not Plug off Power cable until completing the shutdown process.

If you directly interrupt the power supply to the power cable receptacle when the power supply is on, or while turning off the [Line Switch \(Always ON\)](#), the shutdown process will not work. This could damage the SSD of the E4990A.

Do NOT Modify or Reconfigure the Operating System

The Microsoft Windows operating system has been modified and optimized by Keysight to improve the performance of the E4990A.

- Do NOT install standard version of the Windows operating system on the E4990A.
- Do NOT change advanced performance settings or group policies.

- Do NOT add or delete any storage drive partitions on the E4990A.
- Do NOT delete the Keysight user account.
- Do NOT modify any of the Keysight software registry entries.
- Do NOT change the settings of Standards and Formats in Regional Options and Languages from default setting (English).
- DO NOT change the display property.

Install Antivirus Protection

The E4990A does NOT have antivirus protection when shipped. Use of an antivirus program is strongly recommended if you connect the E4990A to the LAN (Internet).

In addition, the use of a firewall could help to protect the E4990A from viruses. However, some firewalls could limit DCOM connectivity of the E4990A.

Install Windows Critical Updates

The E4990A is always shipped with the latest service packs and critical updates that were available at the time when firmware is updated. Keysight recommends you to maintain the latest available protection for your E4990A by automatically accepting and installing the latest critical security patches from the Microsoft Windows Update website:
<http://windowsupdate.microsoft.com>

Precaution for Use of Storage

Do NOT modify or delete any Files and Folders in the drives other than D drive. Doing so will result in malfunctioning of the device. It is required to execute the System recovery if there is any trouble with the above operations.

Precaution for input connector and cable

- Do not apply excessive DC voltage or current to the test port. Applying excessive DC voltage or current may lead to device failure. In particular, the capacitor might remain charged. Connect the measurement sample (DUT) to the test port (or the test fixture, cables, etc. connected to the test port) after the analyzer has been completely discharged. The damage level is described in the [data sheet](#).
- Do NOT bend, bump or flex any device under test (DUT) connected to the input of the E4990A (such as filters, couplers etc). This will reduce the amount of strain placed on the input connector and the

E4990A Impedance Analyzer Help

mounting hardware. Make sure externally connected items are properly supported (not freely suspended) from the input.

- Do NOT bend cables repeatedly, as this may damage the cables instantly. Limit the number of connections and disconnections to reduce wear and tear. Inspect connectors prior to use; look for dirt, nicks, and other signs of damage or wear. A bad connector can ruin a good connector instantly. Clean dirty connectors to prevent poor electrical connections and damage to the connector. For more information on cable and connector care, refer to http://www.keysight.com/find/cable_care

Precautions for Electrostatic Discharge (ESD)

ESD can damage or destroy electronic components. Whenever possible, conduct testing at a static-safe workstation. Keep static-generating materials at least one meter away from all components. Before connecting any coaxial cable to an analyzer, momentarily short the center and outer conductors of the cable together.

Maintain working environment condition

Control your environment. Maintain temperature & humidity with a satisfactory range within the instruments specification and prevent large fluctuations.

Precautions for transportation

- Do NOT lift the instrument with your hands at the front panel. If the instrument slips, damage may occur to the keypad, knob, or input connectors. Lift the Instrument by the handles when transporting.
- Do NOT use styrene pellets as packaging materials as these may cause damage to E4990A by generating static electricity.

Check for Proper Ventilation

Periodically check and clean the cooling vents of the E4990A. Inadequate airflow can result in excessive operating temperatures which can lead to instrument failures. When installing the product in a cabinet, the convection in and out of the instrument must not be restricted.

See the [installation guide](#) for details.

Precautions for Proper Grounding

- Proper grounding prevents building-up of static charge which may be harmful to the E4990A.

- Do NOT defeat the earth-grounding protection by using an extension cable, power cable, or autotransformer without a protective ground conductor.

Before Contacting us

If you encounter the following problems during startup or operation of the E4990A, in which initial registration of the Windows Operating System has been properly performed, execute [system recovery](#) and update the Firmware revision.

The system starts up, but the normal measurement screen does not appear

- The system automatically shuts down immediately after the startup, or the startup process stops.
- The measurement screen appears, but "Power on test fail" or "Calibration data lost" is displayed in the instrument message/warning area against a red background in the lower-left part of the screen. The system enters the service mode. (The instrument status bar in the lower-right displays SVC in red).

Unstable Operation

- The system hangs while the instrument is controlled from an external PCs.
- The blue screen appears and the system hangs.
- The response is much slower than usual.

When execution of [system recovery](#) does not result in normal operation, it indicates that failure may have occurred. Contact [Keysight customer contacts](#).

For other problems, refer to [Troubleshooting](#).

Quick Start

Overview

Overview

- [Front Panel](#)
- [Rear Panel](#)
- [Screen Area](#)

Front Panel: Names and Functions of Parts

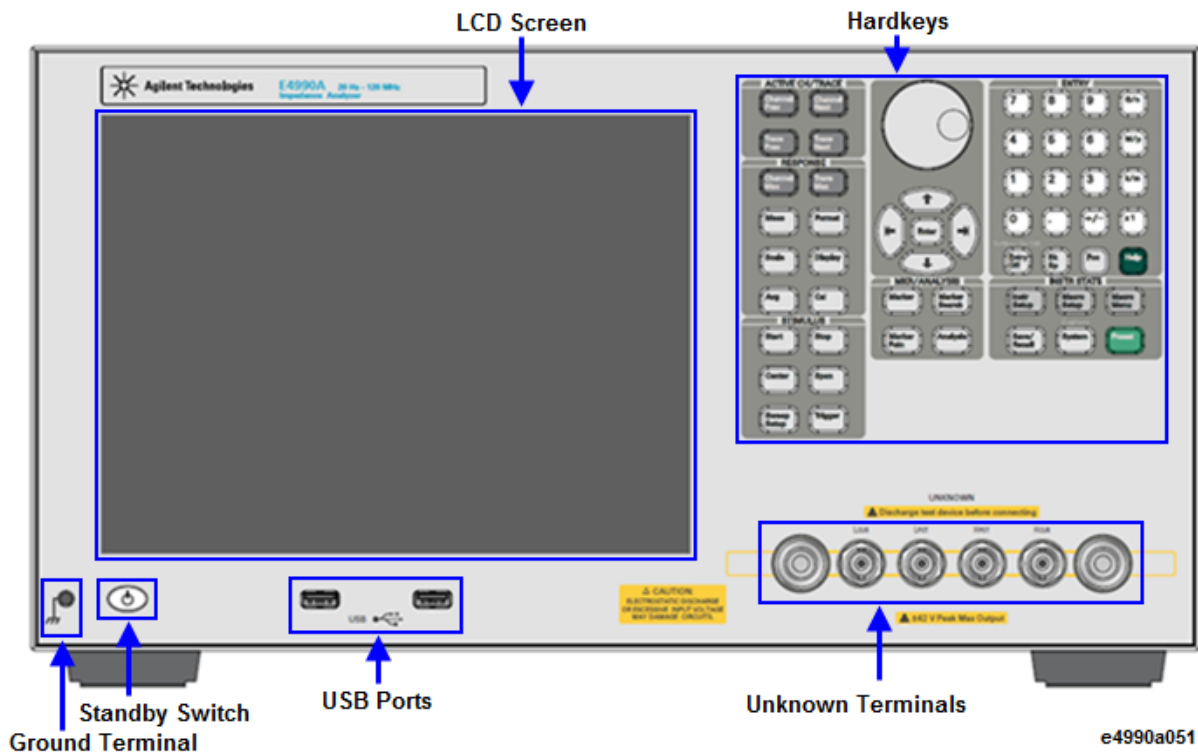

Ground Terminal

Ground terminal is provided with the E4990A and is connected to the chassis of the E4990A. You can connect a banana-type plug to this terminal for grounding.

Hardkeys

ACTIVE CH/TRACE Block

A group of keys for selecting active channels and traces. For more on the concepts of channels and traces, see [Setting Channels and Traces](#).

Hardkey	Description
---------	-------------

Name	
Channel Next	Selects the next channel as the active channel. (Each time the key is pressed, the active channel steps up from the current channel to the channel with one number larger than the current channel number). A channel must be active before you can define such parameters as the sweep range. To change the settings of a channel, use this key to first make the channel active.
Channel Prev	Selects the previous channel as the active channel. (Each time the key is pressed, the active channel steps down from the current channel to the channel with one number smaller than the current channel number).
Trace Next	Selects the next trace as the active trace. (Each time the key is pressed, the active trace steps up from the current trace to the trace with one number larger than the current trace number). A trace must be active before you can define measurement parameters and other settings. To change the settings of a trace, use this key to first make the trace active.
Trace Prev	Selects the previous trace as the active trace. (Each time the key is pressed, active trace steps down from the current trace to the trace with one number smaller than the current trace number).

ENTRY Block

A group of keys used for entering numeric data is provided on the front panel of the E4990A.

Hardkey Name	Description
0, 1, 2, 3 , , 9, ... Keys (numeric keys)	Type numeric characters or a decimal point at the position of the cursor in the data entry area.
+/-	+/- alternately changes the sign (+, -) of a numeric value

	in the data entry area.
G/n, M/u, k/m, x1	Adds a prefix to the numeric data typed by using the numeric key and +/- key. One of the two prefixes written on the surface of the key is automatically selected depending on the parameter to be entered. x1 is entered without a prefix.
Softkey On/Off , Entry Off	Turns off the data entry bar if it is displayed. If the dialog box is displayed, it cancels the entry and closes the dialog box. If the data entry bar and dialog box are not displayed, it turns the softkey menu display on/off.
Bk Sp	Backspace key.
Foc	Changes the selection (focus) among the objects to be manipulated by the NAVIGATION Block keys and ENTRY Block keys. The objects to be manipulated by the NAVIGATION Block keys and ENTRY Block keys include softkey menus, data entry areas, tables (e.g., segment tables, limit tables, and marker tables), and dialog boxes. When two or more of these objects are displayed on the screen and need selecting, use this key to change the selection (focus) among the objects to be manipulated. When a softkey menu is selected, the menu name area at the top of the menu is displayed in blue. When a data entry area is selected, the data entry bar is displayed in blue. When a table is selected, the frame of the table window is displayed in light gray. While a dialog box is displayed, the focus is fixed on the dialog box and cannot be changed.
Help	Displays help for E4990A.

INSTR STATE Block

A group of keys related to the macro function, store and call function, control management function, and presetting of the E4990A (returning it to the preset state).

Hardkey Name	Description
--------------	-------------

Instr Setup	Displays the short-cut keys to make quick setup.
Macro Setup	Displays the Macro Setup Menu in Softkey Menu Bar.
Macro Menu	Displays macro list to be executed which is registered in the macro setup.
Save/Recall	Displays the Save/Recall Menu in Softkey Menu Bar . Manipulating the Save/Recall Menu enables you to store the setup conditions to or read from the storage devices, calibration data, and trace data of the analyzer.
Capture/System	First, temporarily saves the data for the image displayed on the LCD screen the moment this key is pressed to the internal memory (clipboard). Immediately after that, displays the System Menu in Softkey Menu Bar . Manipulating the System Menu enables you to define the setup for the limit test and then execute it, or to define the setup for the control and management of the analyzer. Using the Dump Screen Image option enables you to store the image data in the clipboard to a file on the storage devices. Also, using the Print option in the System menu enables you to print the image data in the clipboard to a printer.
Preset	One message will prompt on the screen display and click OK in the message to return the analyzer to the initial setup state, called as factory state.

MKR/ANALYSIS Block

A group of keys used for analyzing the measurement results by using the markers and etc.

Hardkey Name	Description
Marker	Displays the Marker Menu in Softkey Menu Bar . Manipulating the Marker Menu enables you to turn the markers on/off and move them by entering stimulus values. You can place up to 10 markers on each trace.

<p>Marker Search</p>	<p>Displays the Marker Search Menu in Softkey Menu Bar. Manipulating the Marker Search Menu enables you to move a marker to a specific point (maximum, minimum, peak, and a point with a target value) on a trace. You can also find the bandwidth parameters (up to six) and display them.</p>
<p>Marker Fctn</p>	<p>Displays the Marker Function Menu in Softkey Menu Bar. Manipulating the Marker Function Menu enables you to not only specify the marker sweep range and the coupling of markers on a channel but also to display statistics data on traces.</p>
<p>Analysis</p>	<p>Displays the Analysis Menu in Softkey Menu Bar. Manipulating the Analysis Menu enables you to use the analytical function of the Equivalent Circuit and each limit test.</p>

NAVIGATION Block (No Label on Front Panel)





The keys and Rotary knob in the **NAVIGATION** Block are used to navigate between softkey menus, tables (limit table, segment table, etc.), or selected (highlighted) areas in a dialog box as well as to change a numeric value in the data entry area by stepping up or down. When selecting one of two or more objects (softkey menus, data entry areas, etc.) to manipulate with the **NAVIGATION** Block keys displayed on the screen, first press the **Foc** (Focus) key in the [ENTRY Block](#) to select the object to be manipulated (placing focus on the object) and then manipulate the **NAVIGATION** Block keys (knob) to move among selected (highlighted) objects or change numeric values.

The following descriptions show how the **NAVIGATION** Block keys work both when the focus is on a softkey menu and when the focus is on the data entry area. For more on tables and dialog boxes manipulation, refer to the manipulation procedure for each of these functions.

- **When the focus is on a softkey menu (softkey menu is selected)**

When the focus is placed on a [softkey menu](#) (the menu title area in the uppermost part is displayed in blue), the **NAVIGATION** Block keys work as described below.



Hardkey Name	Description
--------------	-------------

 Rotary Knob (turned clockwise or counterclockwise)	Moves the softkey selection (highlighted display) up or down.
 Up/Down Arrow keys	Moves the softkey selection (highlighted display) up or down.
 Right Arrow key	Displays the softkey menu one layer above.
 Left Arrow keys	Displays the softkey menu one layer below.
Enter or  Rotary Knob (pressed)	Executes the function of the selected softkey.

After pressing the data entry softkey, the focus automatically moves to the data entry area.

- When the focus is on the data entry area (data entry area is selected)

When the focus is placed on the [data entry area](#) (the data entry bar is displayed in blue), the **NAVIGATION** Block keys work as described below.

Hardkey Name	Description
 Rotary Knob (turned clockwise or counterclockwise)	Increases or decreases the numeric value in the data entry area in small steps.
 Up/Down Arrow keys	Increases or decreases the numeric value in the data entry area in large steps.
 Right/Left Arrow keys	Moves the cursor () in the data entry area laterally back and forth. Use it together with the ENTRY Block keys to change data one character at a time.

<p>Enter or  Rotary Knob (pressed)</p>	<p>Finishes the entry in the data entry area and moves the focus to the softkey menu.</p>
--	---

RESPONSE Block

A group of keys used mainly for setting up response measurements on the E4990A.

Hardkey Name	Description
<p>Channel Max</p>	<p>Changes between normal and maximum display of the active channel window. In normal display, all of the defined channel windows (both active and non-active) are displayed in split views on the screen. In maximum display, only the active channel window is displayed over the entire area, with non-active windows not displayed. To maximize the active channel, double-click the channel window frame. Measurements are also carried out on the non-active channels that are not displayed.</p>
<p>Trace Max</p>	<p>Changes between normal and maximum display of the active trace window. In normal display, all of the defined trace windows (both active and non-active) are displayed in split views on the screen. In maximum display, only the active trace is displayed over the entire channel window, with non-active traces not displayed. To maximize the trace, double-click anywhere in the channel window. Measurements are also carried out on the non-active traces that are not displayed.</p>
<p>Meas</p>	<p>Displays the Measurement Menu in Softkey Menu Bar. Manipulating the Measurement Menu enables you to specify the measurement parameters (types of S-parameters) for each trace.</p>
<p>Format</p>	<p>Displays the Format Menu in Softkey Menu Bar. Manipulating the Format Menu enables you to specify the data format (data transformation and graph formats) for each trace.</p>
<p>Scale</p>	<p>Displays the Scale Menu in Softkey Menu Bar.</p>

	Manipulating the Scale Menu enables you to specify the scale for displaying a trace (magnitude per division, value of the reference line, etc.) for each trace. You can also specify the electrical delay and phase offset for each trace.
Display	Displays the Display Menu in Softkey Menu Bar . Manipulating the Display Menu enables you to specify the number of channels and the channel window array, the number and arrangement of traces, the setup for data math, etc.
Avg	Displays the Average Menu in Softkey Menu Bar . Manipulating the Average Menu enables you to define the averaging, smoothing, and IF bandwidth.
Cal	Displays the Calibration Menu in Softkey Menu Bar . Manipulating the Calibration Menu enables you to turn the calibration and error correction on/off and change definitions for calibration kits.

STIMULUS Block

A group of keys for defining the stimulus values (signal sources and triggers).

Hardkey Name	Description
Start	Displays the data entry bar for specifying the start value of the sweep range in the upper part of the screen. (It also displays the Stimulus Menu for specifying the sweep range in Softkey Menu Bar .)
Stop	Displays the data entry bar for specifying the stop value of the sweep range in the upper part of the screen. (It also displays the Stimulus Menu in the same way as Start .)
Center	Displays the data entry bar for specifying the center value of the sweep range in the upper part of the screen. (It also displays the Stimulus Menu in the same way as Start .)

Span	Displays the data entry bar for specifying the span value of the sweep range in the upper part of the screen. (It also displays the Stimulus Menu in the same way as Start .)
Sweep Setup	Displays the Sweep Setup Menu in Softkey Menu Bar . Manipulating the Sweep Setup Menu enables you to specify the signal source power level, sweep time, number of points, sweep type, etc.
Trigger	Displays the Trigger Menu in Softkey Menu Bar . Manipulating the Trigger Menu enables you to specify the trigger mode and trigger source. You can specify the trigger mode for each channel.

LCD Screen

The E4990A is equipped with a 10.4-inch TFT color, touch-sensitive LCD screen for displaying traces, scales, settings, softkeys and other measurement related information. The touch screen LCD allows you to manipulate softkeys by touching the LCD screen directly with a finger. For more on the LCD screen, see [Screen Area: Names and Functions of Parts](#).

CAUTION Do not press the surface of the LCD screen with a sharp object (e.g., nail, pen, or screwdriver). Pressing the surface with a sharp-pointed object will damage the LCD screen surface or cause the screen to fail.

NOTE Valid pixels are 99.998 % and more. Below 0.002% of fixed points of black, blue, green or red are not regarded as failure.

Standby Switch

This switch can turn on/off the E4990A. The color on the button shows the status as shown below:

Indicator Color	Description
Green	Normal power on status.
Orange	Standby status.
Red	Illegal power on status.

To turn off the power of the E4990A, be sure to follow the steps described below:

1. First, press this standby switch or send a shutdown command from the external controller to activate the shutdown process (the processing of software and hardware necessary to turn off the power supply). This will put the E4990A into the standby state.
2. Next, if necessary, turn off power supply to the [Power Cable Receptacle \(to LINE\)](#) on the rear panel.

CAUTION Under normal use, never directly interrupt the power supply to the power cable receptacle on the rear panel when the power supply is on. Always keep the Line Switch (Always ON) at (I). Never turn it off (O).

If you directly interrupt the power supply to the power cable receptacle when the power supply is on, or turn off the Line Switch (Always ON), the shutdown process will not work. This could damage the software and hardware of the E4990A and lead to device failure.

Turning on the power supply after a faulty shutdown may cause the system to start up in a condition called "safe mode." If this occurs, first shut down the system to set it to the standby state and then turn on the power supply again to start up the system in normal mode.



UNKNOWN Terminals

These connectors let you connect the instrument with a device under test (DUT) via test accessories (such as an adapter, test fixture, or cable). These accessories adopt a four-terminal pair design, thereby enabling more accurate and wider-range dynamic measurements. Each test connector has a pair of holes for securing the test accessory to the instrument.

The test ports comply with Installation Category I of IEC 61010-1.

USB Ports

Two USB (Universal Serial Bus) Ports are provided that can be used for connecting to USB keyboard, USB mouse, USB memory or a printer. Connecting a compatible printer to this port enables [screen information on the E4990A to be printed](#). See [Using USB](#) for more detail.

Rear Panel: Names and Functions of Parts

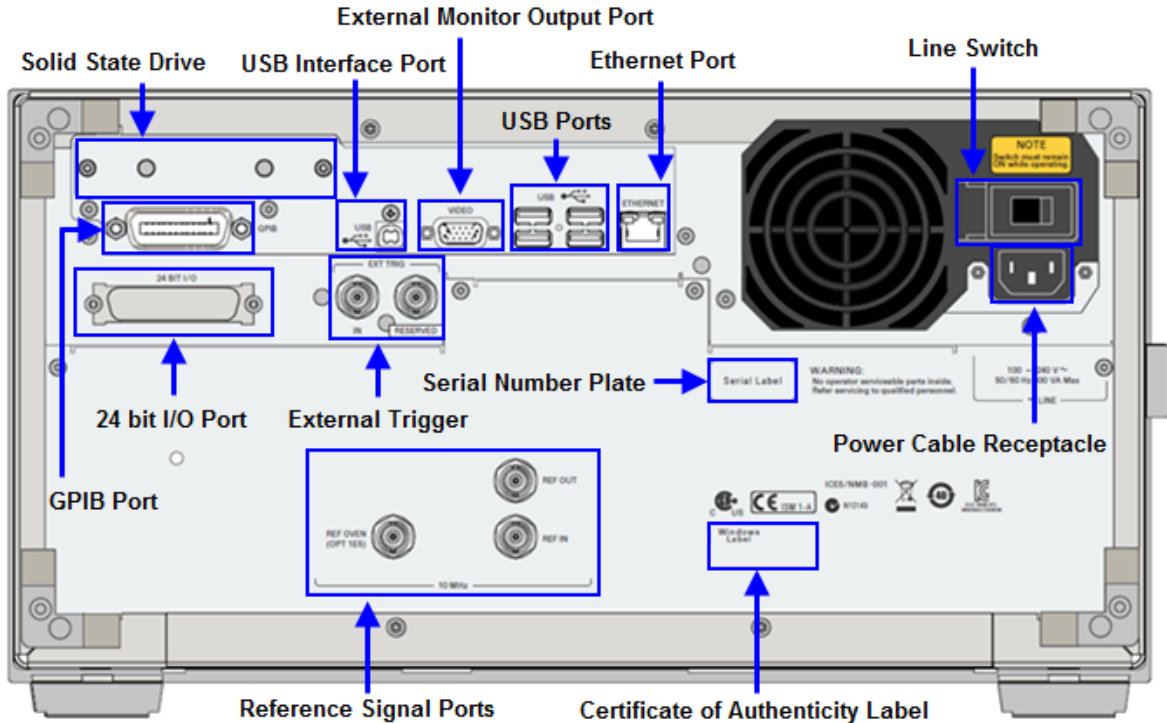

e4990a052

24 Bit (Handler) I/O Port

The terminal to which an automatic machine (handler) used on a production line is connected. See [24 Bit \(Handler\) I/O Port](#).

Connector type: 36-pin Ribbon (Centronics) connector

Certificate of Authenticity Label

The label shows the license information of the Windows Operating System

Ethernet Port

A terminal for connecting the E4990A to a LAN (Local Area Network). Connecting this instrument to a LAN enables you to access the hard disk drive of this instrument from an external PC or to control this instrument by using SICL-LAN or telnet.

Specification	Value
Connector type	8-pin RJ-45 connector
Base Standard	10Base-T/100Base-TX/1000Base-T

External Monitor Output Port (VIDEO)

A terminal to which an external color monitor (display device) can be connected. By connecting a color monitor to this terminal, the same

information shown on the LCD screen of the main body can be displayed on an external color monitor.

Connector type: 15-pin VGA connector, female

External Trigger (EXT TRIG)

Input

A connector to which external trigger signals are input. This connector detects the downward transition from the HIGH state in TTL signals as the trigger signal. To use this connector to generate a trigger, you must set the [trigger source](#) to the "external" side. The connector type is BNC, female.

GPIB Port

The connection of an external controller through General Purpose Interface Bus (GPIB) connector allows you to configure an automatic measurement system.

This GPIB port is used only for controlling the E4990A from an external controller. Use USB/GPIB interface to control other devices from the E4990A. You cannot control other devices from the E4990A through this GPIB port.

Solid State Drive (SSD)

Built in solid state drive.

Reference Signal Ports (10MHz)

The specification for the signals is specified in the [data sheet](#).

Input (REF IN)

The reference signal input connector is used for phase-locking the measurement signal from the E4990A to the external frequency reference signal. Inputting reference signal to this connector improves the accuracy and frequency stability of the measurement signal from the E4990A. When the frequency reference signal is input to this connector, the measurement signal from the E4990A is automatically phase-locked to the reference signal. When an input signal is not present, the frequency reference signal inside the E4990A is automatically used. The [ExtRef](#) on the [instrument status bar](#) is displayed in blue when the system is phase-locked to the external reference signal and in gray when not phase-locked.

When using Option 1E5 (high stability time base), connect this connector to the REF OVEN by using the BNC(m)-BNC(m) cable included with the option.

Output (REF OUT)

A connector for outputting the internal frequency reference signal from the E4990A. By connecting this output connector to the external reference

E4990A Impedance Analyzer Help

signal input connector of another device, the device can be phase-locked to the internal reference signal of the E4990A and used under this condition.

High Stability Frequency Reference Output (REF OVEN, OPT 1E5)

When Option 1E5 (high stability time base) is installed, the reference signal is output from this connector. Connect this connector to the REF IN by using the BNC(m)-BNC(m) adapter included with the option.

Line Switch (Always ON)

Always keep this switch on (I).

CAUTION

Do not use this switch to turn off (O) the mains. Doing so may cause the analyzer to fail. For more information, see the description of the [Standby Switch](#).

Power Cable Receptacle (to LINE)

The receptacle (outlet) to which the power cable is connected.

NOTE

To connect the device to a power source (outlet), use the supplied three-prong power cable with a ground conductor. The plug attached to the power cable (on the power outlet side or device side of the cable) serves as the disconnecting device (device that cuts off power supply) of the E4990A. When the power supply must be cut off to avoid such danger as electric shock, pull out the power cable plug (on the power outlet side or device side of the cable). For the procedure for turning off the main in normal use, see the description in [Standby Switch](#).

For more on the power supply, see the [Installation Guide](#).

Serial Number Plate

The label showing the product number, serial number and the installed option number. The accessory and system rack options are not listed on this label. (CFGxxx or ATOxxx in the first line is Keysight Use Only.)

USB Interface Port (USBTMC)

Through this port, you can control the E4990A from external controllers. For more information on the measurement system using the USB port, see the [USB Remote Control System](#).

Specification	Value
Connector type	Universal serial bus (USB), type B (4 contact positions), Female (jack)
Compliance Standards	USBTMC-USB488 and USB2.0

USB Ports

Four USB (Universal Serial Bus) ports are provided that can be used for connecting to USB keyboard, USB mouse, USB memory or a printer.

Connecting a compatible printer to this port enables [screen information on the E4990A to be printed](#). See [Using USB](#) for more detail.

Screen Area

Screen Area: Names and Functions of Parts



Click on the name or area for details of the topic.

- [Channel Window](#)
- [Data Entry Bar](#)
- [Instrument Status Bar](#)
- [Menu Bar](#)

- [Softkey Menu Bar](#)

Channel Window

Window for displaying the traces. Because a channel corresponds to a window, it is called a channel window. When the outer frame of a channel window is displayed in light gray, it shows that the channel is an active channel (the channel for which setup is being performed). In the following figure, Channel 1 (the upper window) is the active channel.

Channel 1 Window and Channel 2 Window describes different measurement parameters available in the channel measurement window. The measurement parameters described in the Channel 1 and 2 Window correspond to the same channel measurement window and are displayed in separate windows for ease of read.

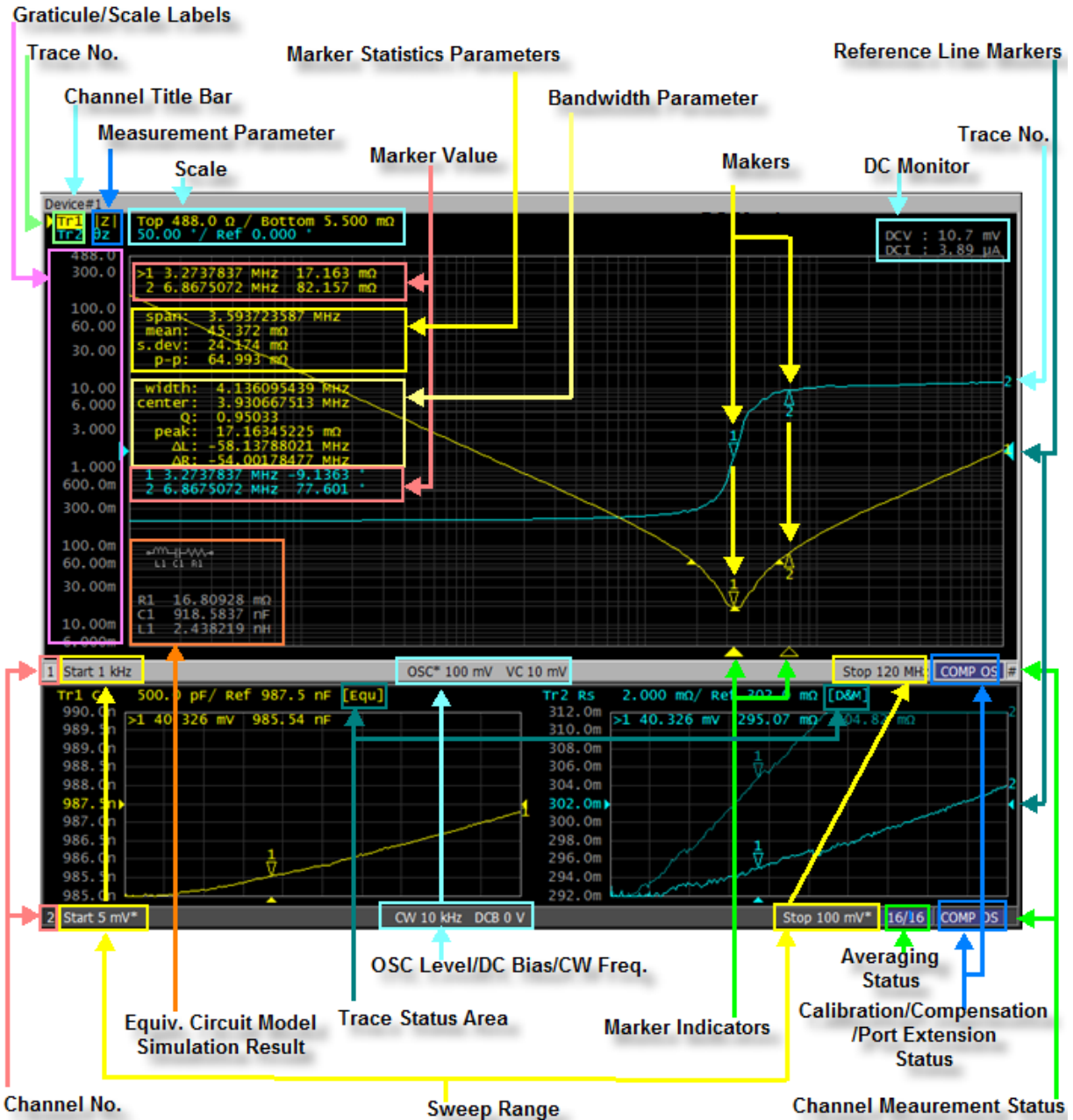

Averaging Status

Displays the averaging factor and averaging count when [averaging](#) is turned on.

n/m (displayed in blue)	Averaging: ON (m: averaging factor; n: averaging count)
(not displayed)	Averaging: OFF

E4990A Impedance Analyzer Help

Bandwidth Parameter

It shows the bandwidth data for a trace when the [bandwidth function](#) is turned on.

Calibration/Compensation/Port Extension Status

Calibration Status

	Correction Point: Fixed Freq	Correction Point: User Freq
User Correction: On	COR	Cor (Neither interpolation nor extrapolation is being executed.)
		C? (Interpolation is being executed.)
User Correction: Off	None	

Compensation Status

Status			Indicator display	
Open	Short	Load	Fixed point	User point
Off	Off	Off	None	None
On	Off	Off	Comp O	COMP O
Off	On	Off	Comp S	COMP S
Off	Off	On	Comp L	COMP L
On	On	Off	Comp OS	COMP OS
On	Off	On	Comp OL	COMP OL
Off	On	On	Comp SL	COMP SL
On	On	On	Comp OSL	COMP OSL

When the span is narrowed from the span of compensation in "user point", ? is displayed after COMP, like COMP? OSL.

Port Extension Status

PEXT or **PExt** is displayed when Port Extension is turned on and Length or Time is not zero.

- **PEXT**: [Fixed point](#)
- **PExt**: [User point](#)

Channel Number

Indicates the channel number. To make a channel active, use **Channel Next** or **Channel Prev**. Clicking inside a channel window will also make the channel active.

Channel Measurement Status

Displays the update status of traces on the channel.

!	Measurement in progress. When the sweep time exceeds 1.5 seconds, ↑ is displayed at the point on the trace.
#	Invalid traces. The measurement conditions have changed, but the traces on the channel currently displayed have not been updated to match the new conditions.
(No display)	The measurement has not been executed.

Channel Title Bar

You can assign a [title to each channel](#) and have the title displayed on the bar.



DC Monitor

DC Monitor values are displayed when the [DC monitor function](#) is turned on.

Equivalent Circuit Model/Simulation Result

Equivalent Circuit Model/Simulation Result are displayed for the [equivalent circuit](#).

Graticule/Scale Labels



Y-axis divisions in the rectangular display format. When traces in the rectangular display format are overlaid, the Y-axis divisions for the active trace are displayed. The value of the reference line (the division line between ► and ◀) is entered numerically by opening the data entry bar using the keys: **Scale** > **Reference Value**. You can change values of the reference line at one-division intervals by placing the mouse pointer in the area of the graticule label (the pointer changes from  to ) , moving the



E4990A Impedance Analyzer Help

pointer vertically with the left mouse button pressed, and then releasing the button at the desired location.

Marker Indicators

Indicates the positions of markers on the stimulus axis.

	Active marker indicator
	Non-active marker indicator

You can also move a marker to the desired position by placing the mouse pointer on the marker indicator or position of the marker itself (the pointer changes from  to ) , moving the indicator vertically with the left mouse button pressed, and then releasing the button at the desired location.

Marker Numbers



Displayed marker number is listed. For the active marker (the one for which setup and analysis are being performed), > is displayed at the left of the marker number. For the reference marker,  is displayed instead of the marker number.

Marker Values

The marker stimulus and response values for each marker is displayed here. Two (or three) response values are displayed for data in Smith chart or polar display format.

Markers

The markers used for reading values on a trace. Up to 10 markers can be displayed for each trace.

	Active marker (the one for which setup and analysis are being performed).
	Non-active marker.

Here, "n" denotes a marker number. For the reference marker, however, nothing is displayed at the location of n. Clicking the marker or one of the [Marker Indicators](#) makes the marker active.

Marker Statistic Parameters

It shows the statistics data for a trace (span, mean, standard deviation, and peak-to-peak) when the statistic function is turned on.

Measurement Parameter

Measurement parameters are displayed.

OSC Level/DC Bias/CW Frequency

Indicates the OSC level, DC Bias and CW frequency in the following conditions.

Indicator type	Sweep type
OSC level	Frequency (Liner/Log) and DC Bias
DC Bias (when DC bias is ON)	Frequency (Liner/Log) and OSC level
CW frequency	OSC level and DC Bias

Reference Line Indicators

The indicators that indicate the position of the reference line for the Y-axis scale in the rectangular display format. One indicator is to the right and the other is to the left of the scale (▶ and ◀). To enter a numeric value for the position of the reference line, open the data entry bar using the keys: **Scale** > **Reference Position**. You can also move the position of the reference line by placing the mouse pointer on either of the two reference line

indicators (the pointer changes from  to ) , moving the indicator vertically with the left mouse button kept pressed, and then releasing the button at the desired location (i.e., a drag-and-drop operation).

Scale

The [scale](#) for each trace is displayed here.

- When Linear scale is selected at Y-Axis
The [scale/Div and Reference values](#) are displayed.
This example shows that "50.00°" corresponds to 50° per division.
"Ref 0.000°" shows that the value of the reference line is 0°.
- When Log scale is selected at Y-Axis
The [top and bottom values of Y-Axis](#) are displayed.



Sweep Range

Indicates the sweep range by using the start/stop or center/span.

Trace Number

The names of the traces, such as Tr1, on the channel are displayed here. The symbol ▶ at the right of the trace name indicates the active trace (the trace for which setup is being performed).

To make a trace active, use **Trace Next** or **Trace Prev**. Clicking the line

where the trace name is placed (the mouse pointer changes from  to ) also makes a trace active.

In the rectangular display format, the trace number is displayed in the same color as the trace at the right end of each trace.

Trace Status Area

The setup for each trace is displayed here.

Trace status display

Classification	Contents inside []	Meaning
Memory traces	Nothing	Data trace: ON, Memory trace: OFF
	M	Data trace: OFF, Memory trace: ON
	D&M	Data trace: ON, Memory trace: ON
	off	Data trace: OFF, Memory trace: OFF
Performing data math When a memory trace is ON, see the contents inside ()	D+M (D+M&M)	Execution of Data+Mem math
	D-M (D- M&M)	Execution of Data- Mem math
	D*M (D*M&M)	Execution of Data*Mem math
	D/M (D/M&M)	Execution of Data/Mem math
Equation Editor	Equ	Equation Editor: ON

Data Entry Bar

Used to enter numeric data into the E4990A. Press a hardkey or softkey to enter data, and the data entry bar will appear at the top of the screen. To assign a title to a channel window, an entry bar that allows you to enter letters and symbols by using the front panel keys or mouse is displayed.

Data entry bar

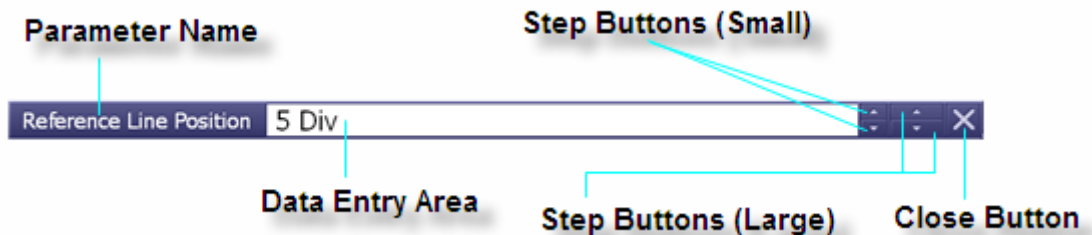

NOTE To manipulate the data entry bar by using the front panel keys, the data entry bar must be selected as the object to manipulate (with the focus placed on it). When the focus is placed on the data entry bar, the entire bar is displayed in blue. Pressing or clicking **Foc** Key in the [ENTRY Block](#) enables you to move the focus to the desired object.

Close Button

Closes the data entry area (turns off the display). Use mouse to manipulate this button.

Data Entry Area

When the data entry bar is displayed for the first time, the current settings are displayed on it. You can change numeric values by typing from the keyboard or in the ENTRY block on the front panel.

You can hide the frequency information in order to ensure its confidentiality or for other reasons. For detailed information, see [Hiding Softkey's Frequency Information](#).

Parameter Name

Displays the name of the parameter for which data will be entered.

Step Button (Small)

Increases or decreases the numeric value in the data entry area in small steps. Use the mouse to manipulate this button.

Step Button (Large)

Increases or decreases the numeric value in the data entry area in large steps. Use the mouse to manipulate this button.

Instrument Status Bar

The instrument status bar displays the status of the entire instrument.

E4990A Impedance Analyzer Help

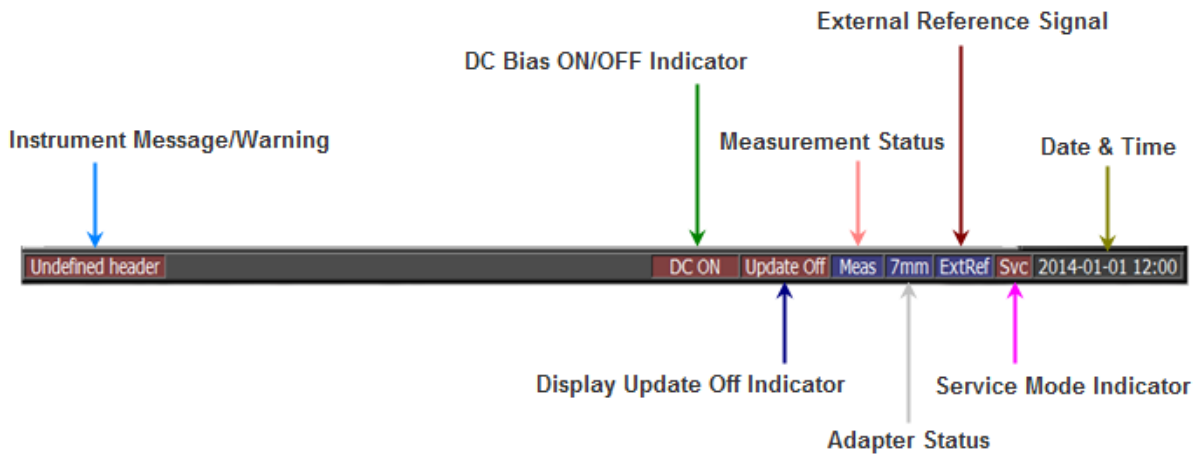

e4990a054

Instrument Message/Warning

Displays [instrument messages and warnings](#). Instrument messages are displayed in gray and warnings in red.

DC Bias ON/OFF Indicator

Value	Description
DC ON (displayed in red)	DC Bias is turns ON.
DC OFF (displayed in dark)	DC Bias is turns OFF.

Display Update Off Indicator

When information update display on the LCD screen is turned off, this indicator is displayed in red.

Measurement Status

Displays the measurement status of the E4990A.

Value	Description
Setup	Setup for measurement in progress
Hold	Measurement on hold (idling)
Man	The trigger source is set to "Manual" and waiting for trigger.
Ext	The trigger source is set to "External" and waiting for trigger.

Bus	The trigger source is set to "Bus" and waiting for trigger.
Meas	A measurement is in progress.

Adapter Status

The adapter status of E4990A shows types of adapter in used.

Value	Description
Ext1	Adapter 4TP 1m.
Ext2	Adapter 4TP 2m .
Probe	Adapter Probe 42941A or 42941A Extension.
7mm	Adapter 7mm 42942A or 42942A Extension.

NOTE

When no adapter to be chosen, the adapter status will not appear.

External Reference Signal

When the frequency reference signal is input to the Reference Signal Input (REF IN) on the rear panel and the measurement signal of the E4990A is phase-locked to the reference signal, **ExtRef** is displayed in blue.

Value	Description
ExtRef (displayed in red)	Measurement signal is not phase-locked to the external reference signal.
ExtRef (displayed in blue)	Measurement signal is phase-locked to the external reference signal.
ExtRef(displayed in gray)	Internal reference signal is used as frequency reference signal.

Service Mode Indicator

Indicates the service mode status. The service mode indicator is displayed when E4990A enters the following state.

Value	Description
-------	-------------

SVC (displayed in red)	An abnormal condition has been detected inside the E4990A. The unit may be damaged. Notify the Customer Contact listed at the end of this manual or the distributor from whom the unit was purchased.
----------------------------------	---

Date and Time

Displays the date and time generated by the internal clock. The display format is as follows:

YYYY-MM-DD HH:MM

Where:

YYYY: Year (AD)

MM: Month

DD: Day

HH: MM: Time (0:00 to 23:59)

NOTE

You can turn the date and time display on/off by: **System**
> **Misc Setup** > **Clock Setup** > **Show Clock**.

Menu Bar

By using the mouse and keyboard to manipulate the menu bar, you can perform interface operations that are equivalent to those of the keys in the **ACTIVE CH/TRACE** Block, **RESPONSE** Block, **STIMULUS** Block, **MKR/ANALYSIS** Block, and **INSTR STATE** Block on the front panel of the E4990A. The menus on the menu bar correspond to the key blocks, and their submenus to the hardkeys inside the key blocks.

Softkey Menu Bar

A group of keys on the screen called by the softkeys and menu bars. You can manipulate these keys by using the **NAVIGATION** Block keys on the front panel, the mouse, or the keyboard. You can perform manipulations by directly touching the screen with your finger instead of using a mouse.

Softkey Menu Bar

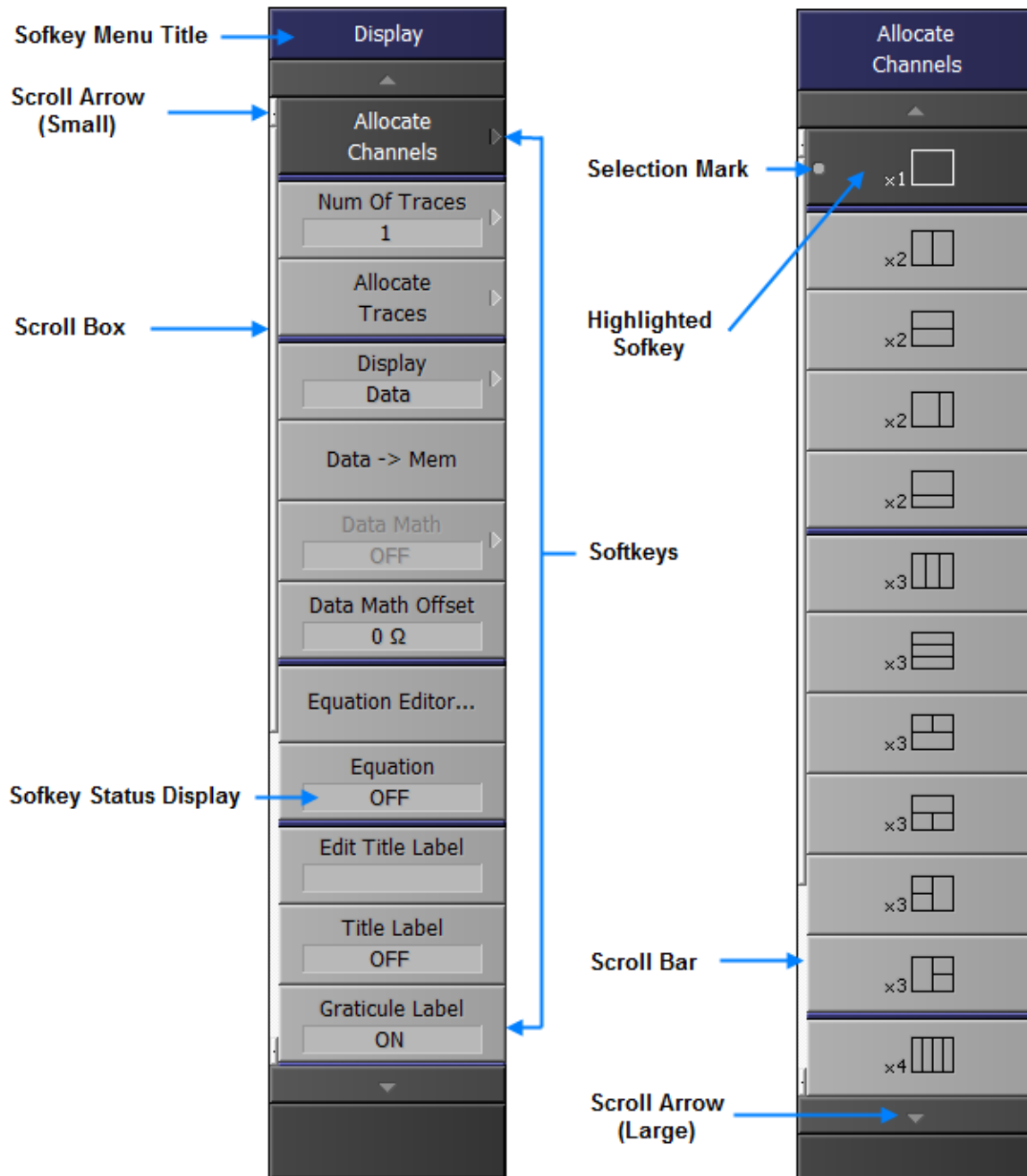





e4990a056





NOTE

To manipulate a menu bar, it has to be selected as the object to manipulate (with the focus placed on it). When the focus is placed on a menu bar, the menu title area at the top is displayed in blue. Pressing or clicking on **Foc** key in the [ENTRY Block](#) enables you to move the focus to the desired object.

Highlighted Sofkey

E4990A Impedance Analyzer Help

Pressing  and **Enter** key on the front panel or pressing **Enter** key on the keyboard causes the highlighted (selected) softkey to be executed. You can change which softkey in the menu is highlighted by turning  or pressing  key on the front panel or by pressing  key on the keyboard.

Pressing the  key on the front panel or the  key on the keyboard brings up the upper level softkey menu, and pressing the  key on the front panel or the  key on the keyboard brings up the lower level softkey menu.

Scroll Arrow (Large)

When the softkeys in a menu overflow the screen, use this key to enable you to scroll the menu page by page. Both upward and downward scroll arrows are available. Use the mouse to manipulate these buttons.

Scroll Arrow (Small)

Using this button, you can scroll the menu one softkey at a time. Both upward and downward scroll arrows are available. Use the mouse to manipulate these buttons.

Scroll Bar

When the softkeys in a menu overflow the screen, clicking on the blank part of the scroll bar enables you to scroll the softkey menu up or down.

Scroll Box

You can scroll the softkey menu up or down by using the mouse to select and drag the scroll box (pressing the button on the object to be moved and then releasing the button at the desired location). The length and position of the scroll box indicate the length and position of the currently displayed part of the softkey menu relative to the entire menu.

Selection Mark

Shows which softkey function is currently selected.

Softkeys

These are the actual keys you would use to perform setup. A  displayed to the right of a softkey indicates that pressing that softkey displays the lower layer of softkeys.

Softkey Menu Title

The title of the softkey menu is displayed here. Double-clicking on this part of the menu bar displays the top layer of softkeys.

Softkey Status Display

Displays a softkey's setup status.

You can hide the frequency information in order to ensure its confidentiality or for other reasons. See [Hiding Softkey's Frequency Information](#).

Measurement Example

Measurement Example

This chapter guides you through a tour of the basic measurement functions of the E4990A Impedance Analyzer. If you are new to the E4990A, this tutorial should help you get familiar with the instrument.

- [Required Equipment](#)
- [Preparing for a Measurement](#)
- [Specifying Measurement Conditions](#)
- [Fixture Compensation](#)
- [Carrying Out Measurement and Viewing Results](#)
- [Results of Analysis](#)
- [Softkey Shortcuts](#)

Required Equipment

To perform all of the steps in this example, you must have the following equipment:

- E4990A Impedance Analyzer (1 unit)
- 16047E Test Fixture for Lead Components (1 piece)
- DUT: Capacitor with lead wires having self-resonance frequency of 100 MHz or lower, such as a 0.1 μF ceramic capacitor (1 piece)

[Other topics about Measurement Example](#)

Preparing for a Measurement

- [Connect the 16047E Test Fixture](#)
- [Turn ON the Power](#)

[Other topics about Measurement Example](#)

Prepare the E4990A for measurement by taking the following steps. This procedure assumes that the E4990A has been correctly installed and set up.

Connect the 16047E Test Fixture

Connect the E4990A to the 16047E Test Fixture for Lead Components.

1. Attach the 16047E test fixture to the test connectors on the front panel of the E4990A by gradually coupling the four BNC connectors and fastening screws of the fixture with the test connectors and accessory mounting holes of the instrument until they are in complete contact.

E4990A Impedance Analyzer Help

2. Fasten two of the four BNC connectors to the corresponding test connectors by gradually turning the BNC connectors' rotation levers until each pair of connectors is securely connected. Be sure to align the grooves on both sides.
3. Simultaneously turn the fixture's two fastening screws clockwise so that the fixture is secured to the instrument.
4. Finally, secure the remaining two BNC connectors of the fixture by turning their rotation levers clockwise.



e4490a001

NOTE

Reverse the above procedure when removing the 16047E Test Fixture.

Turn ON the Power

Press the power switch to turn ON the power to the E4990A. The E4990A performs a power-on self-test. During the self-test, the model name, firmware revision number/date, options, copyright notice, and other information appear on the LCD. When the self-test is completed, the measurement screen appears on the LCD.

Specifying Measurement Conditions

- [Initialize the E4990A to the Preset State](#)
- [Select Fixture](#)
- [Select \$|Z|\$ -Theta as the Measurement Parameter](#)
- [Select Frequency in Log as the Sweep Parameter](#)
- [Set the Sweep Start/Stop Value](#)
- [Set the Measurement Speed](#)

[Other topics about Measurement Example](#)

Next, you need to specify how your E4990A should perform the measurement.

NOTE

Through this procedure, you will configure parameters that apply to both Traces, A and B. You can set each parameter without specifying the active trace or checking its current settings.

Initialize the E4990A to the Preset State

Press the **Preset** key to initialize the E4990A.

This puts the E4990A into its preset state.

NOTE

If you turn on the E4990A with a power-on setting file residing on the flash memory (nonvolatile memory disk), the file is automatically loaded, and the settings contained in the file are restored. Initializing the E4990A to its preset state ensures that no specific settings are inherited from the last measurement session. Therefore, you should initialize the E4990A by pressing the **Preset** key whenever you are configuring it for a new measurement session, regardless of whether you turned the instrument off and back on after the previous session.

NOTE

Note that initializing the E4990A with the **Preset** key does not affect which type of adapter the instrument is configured to use. Once you have set the adapter type, the setting is retained until you select another adapter type.

Select Fixture

1. Press the **Cal** key to display the **Cal Compn** (Calibration Compensation) menu.
2. Select the 16047E test fixture by clicking **Accessory > 16047E**.

Select |Z|-Theta as the Measurement Parameter

To select the measurement parameter, follow these steps:

1. Press the **Meas > Measurement** key to display the **Measurement** menu.
2. Ensure that the **|Z|- θ z** key is selected for **Trace 1 & 2** (this key is selected by default in the preset state). With this selection, Trace 1 reflects the absolute impedance value while Trace 2 reflects the impedance phase.

Select Frequency in Log as the Sweep Parameter

1. Press the **Sweep Setup** key to display the **Sweep Setup** menu.
2. At **Sweep Type** softkey, select **Log Freq** (Logarithmic Frequency).

Set the Sweep Start/Stop Value

1. Press the **Start** key. The current setting of the sweep start value appears at the **Start** parameter.

2. Enter **100 Hz**.
 - If you are using the ENTRY block keys, type: [1][0][0], and press the [1] key in the ENTRY block. This puts your entry into effect.
3. Press the **Stop** key. The current setting of the sweep stop value appears at the **Stop** parameter.
4. Enter **100 MHz**.
 - If you are using the ENTRY block keys, type: [1][0][0], and press the [M/m] key in the ENTRY block. This puts your entry into effect.

Set the Measurement Speed

1. Press the **Avg** key to display the **Average** menu.
2. Click the **Meas Time** and select **2** as the measurement bandwidth.
 - Meas Time 1 provides the fastest measurement and 5 provides the slowest but more precise measurement.

Fixture Compensation

- [Perform Fixture Compensation for the Open Circuit State](#)
- [Perform Fixture Compensation for the Short Circuit State](#)

[Other topics about Measurement Example](#)

Next, you need to eliminate errors produced between the test fixture and the E4990A. This process is called “fixture compensation.” You can perform the process by using three compensation functions: OPEN, SHORT, and LOAD.

NOTE

All calibration settings, including those established through fixture compensation, are applied to both Traces 1 and 2. You can execute each compensation function without specifying the active trace or checking the current state.

Perform Fixture Compensation for the Open Circuit State

1. Press the **Cal** key to display the **Cal Comp** (Calibration Compensation) menu.
2. Press the **Fixture Comp** softkey to display the **Fixture Comp** (Fixture Compensation) menu.
3. Ensure that the two test electrodes, HIGH and LOW, of the connected test fixture (16047E) are open. Fix the two electrodes in position by turning clockwise the fixture’s two electrode fastening screws.

- Press the **Open (0 S 0 F)** softkey to measure the OPEN compensation data. While the instrument is measuring the compensation data, "Sweeping..." message is displayed on the Instrument Status Bar at the bottom-left area of the screen. Upon completion of measurement, the **OPEN** softkey label changes to **ON**, indicating that the OPEN compensation function is turned on.

Perform Fixture Compensation for the Short Circuit State

- Place the short bar (a metal plate for SHORT compensation) between the HIGH and LOW terminals of the 16047E. Secure the short bar with the two electrode fastening screws as shown below.

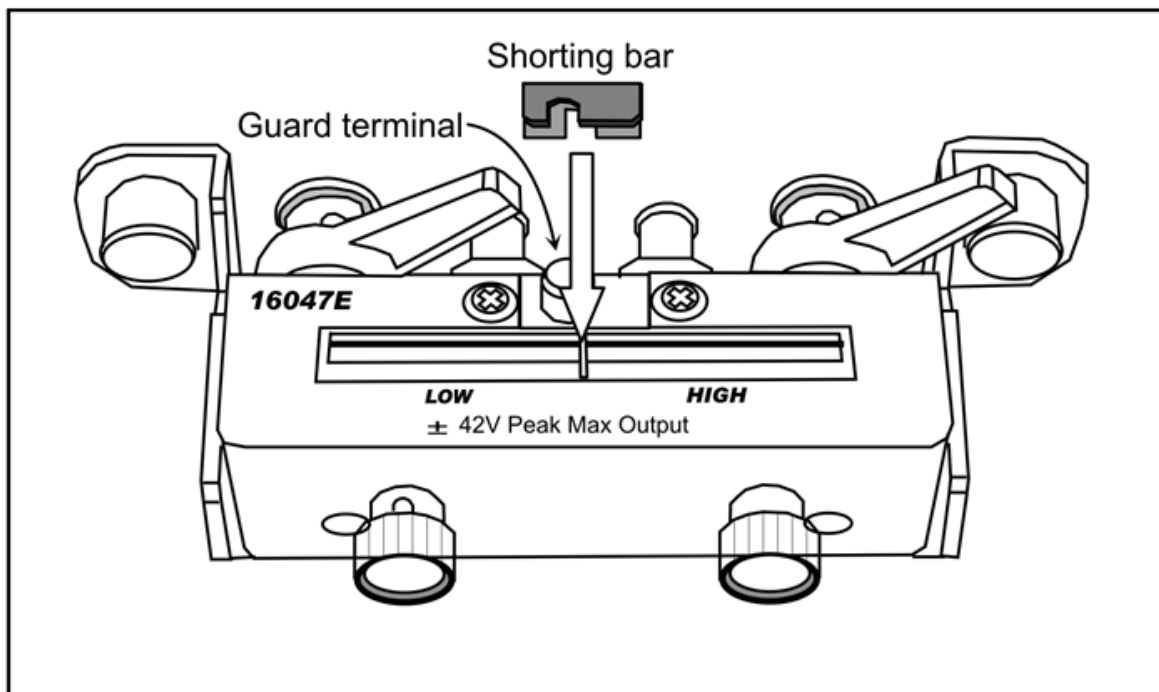

e4990a002

- Press the **Short (0 Ω 0 H)** key to measure the SHORT compensation data. While the instrument is measuring the compensation data, "Sweeping..." message is displayed on the Instrument Status Bar at the bottom-left area of the screen. Upon completion of measurement, the **SHORT** softkey label changes to **ON**, indicating that the SHORT compensation function is turned on.
- Remove the short bar from the 16047E's test electrodes.

NOTE The E4990A provides three fixture compensation functions: OPEN, SHORT, and LOAD. You can turn on/off each of these compensation functions individually and use them in any combination to perform the fixture compensation process. In typical measurement use, it is recommended that you execute the OPEN and SHORT compensation functions.

Carrying Out Measurement and Viewing Results

- [Connect the DUT](#)
- [Apply the Logarithmic Format to the Vertical Axis for |Z|](#)
- [Apply the Linear Format to the Vertical Axis for Theta](#)
- [Display the Measured |Z| and Theta Values in Parallel](#)
- [Auto-scale the Traces](#)

[Other topics about Measurement Example](#)

Connect the DUT

1. Increase the distance between the HIGH and LOW electrodes of the 16047E by turning their fastening screws counterclockwise.
2. Fit the DUT's lead wires between the HIGH and LOW electrodes.
3. Turn the fastening screws of the HIGH and LOW electrodes to secure the DUT's lead wires.

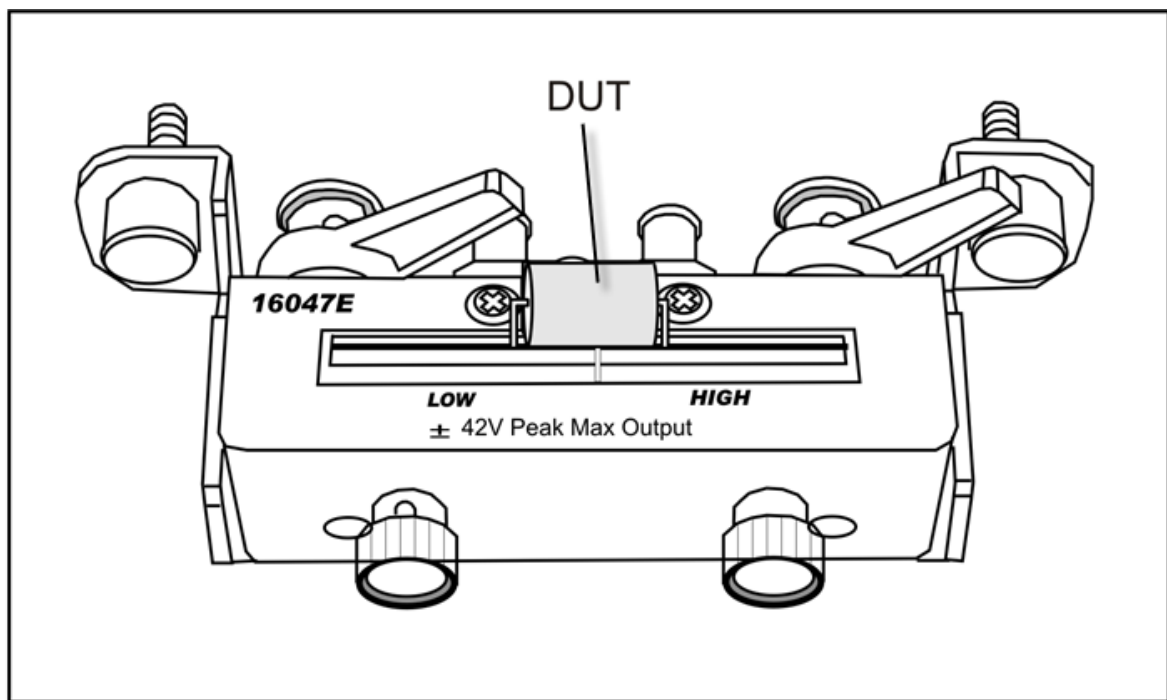

e4990a003

The measurement results displayed just upon connecting the DUT is as shown below.

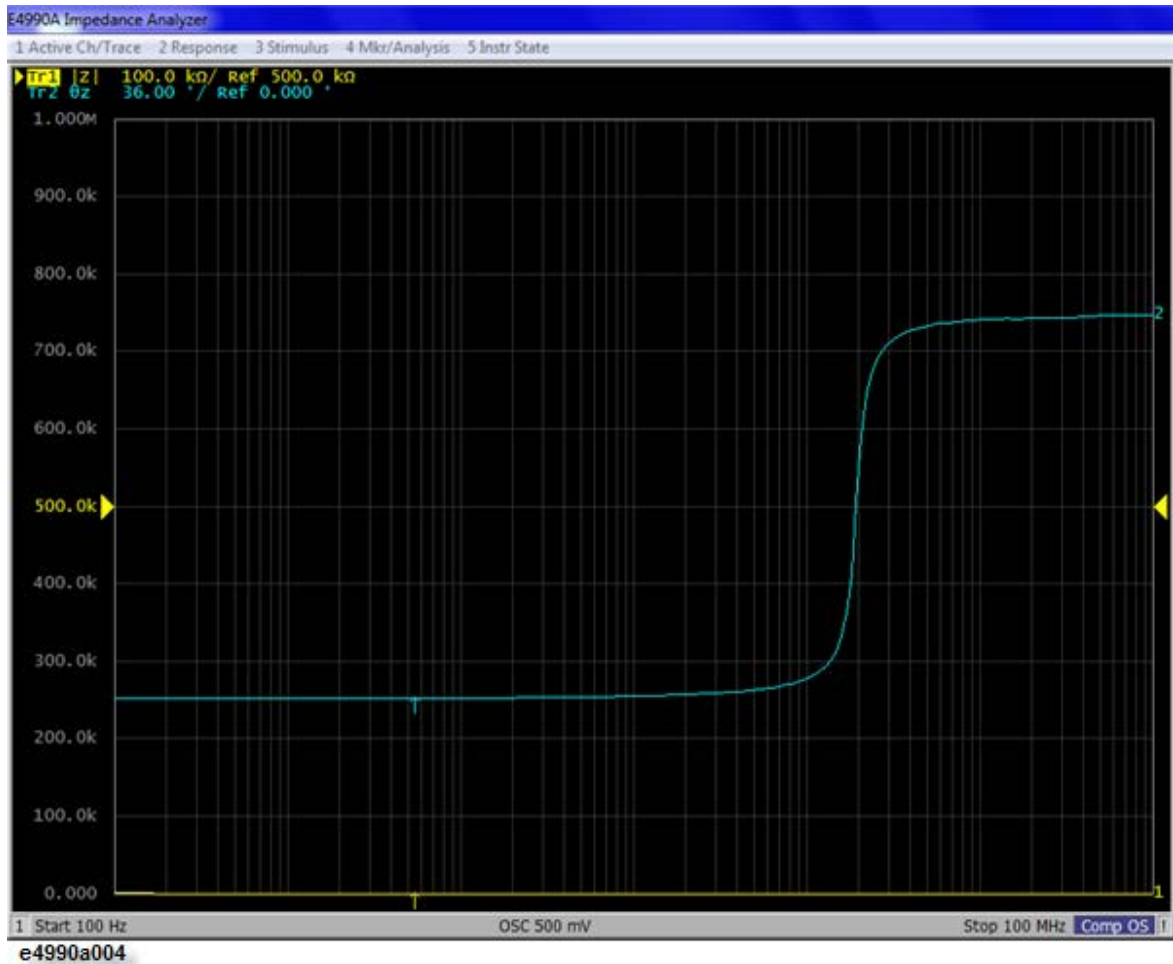

Apply the Logarithmic Format to the Vertical Axis for |Z|

1. Ensure that Trace 1 is selected as the active trace (Trace 1 is active by default in the preset state).
2. Press the **Format** key to display the **Format** menu.
3. Select **Log** for **Y-Axis** to make the graph's vertical axis logarithmic.

Apply the Linear Format to the Vertical Axis for Theta

1. Activate Trace 2 by pressing **Trace Next**.
2. Ensure that **Lin** (linear format) is selected for **Y-Axis** (this setting is selected by default in the preset state).

The result of applying the logarithmic format to the graph is shown below.

E4990A Impedance Analyzer Help

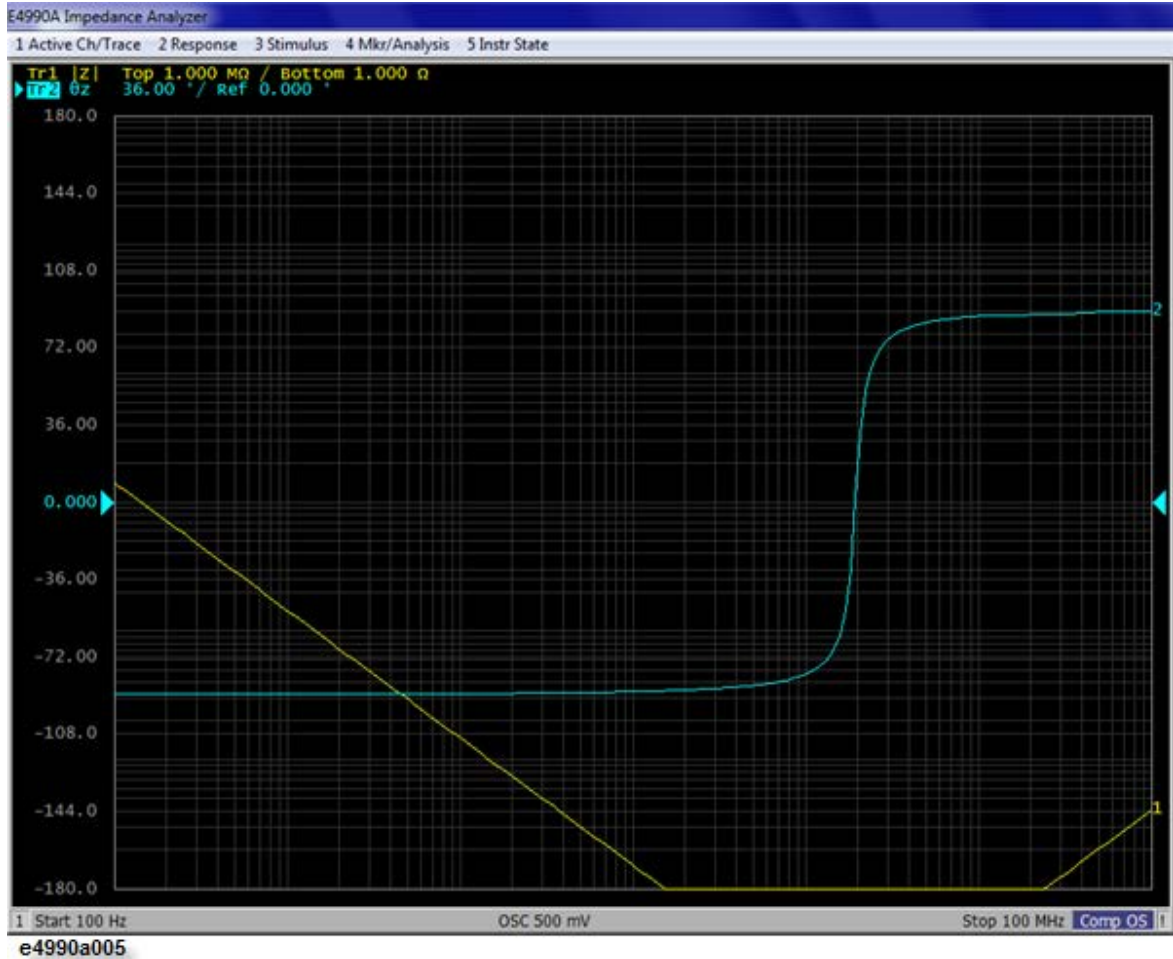

Display the Measured $|Z|$ and Theta Values in Parallel

1. Press the **Display** key to display the **Display** menu.

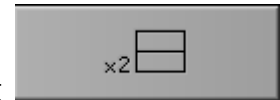

2. Select **Allocate Traces** and select 2 horizontal split
Once split is applied, the graph will be as shown below.

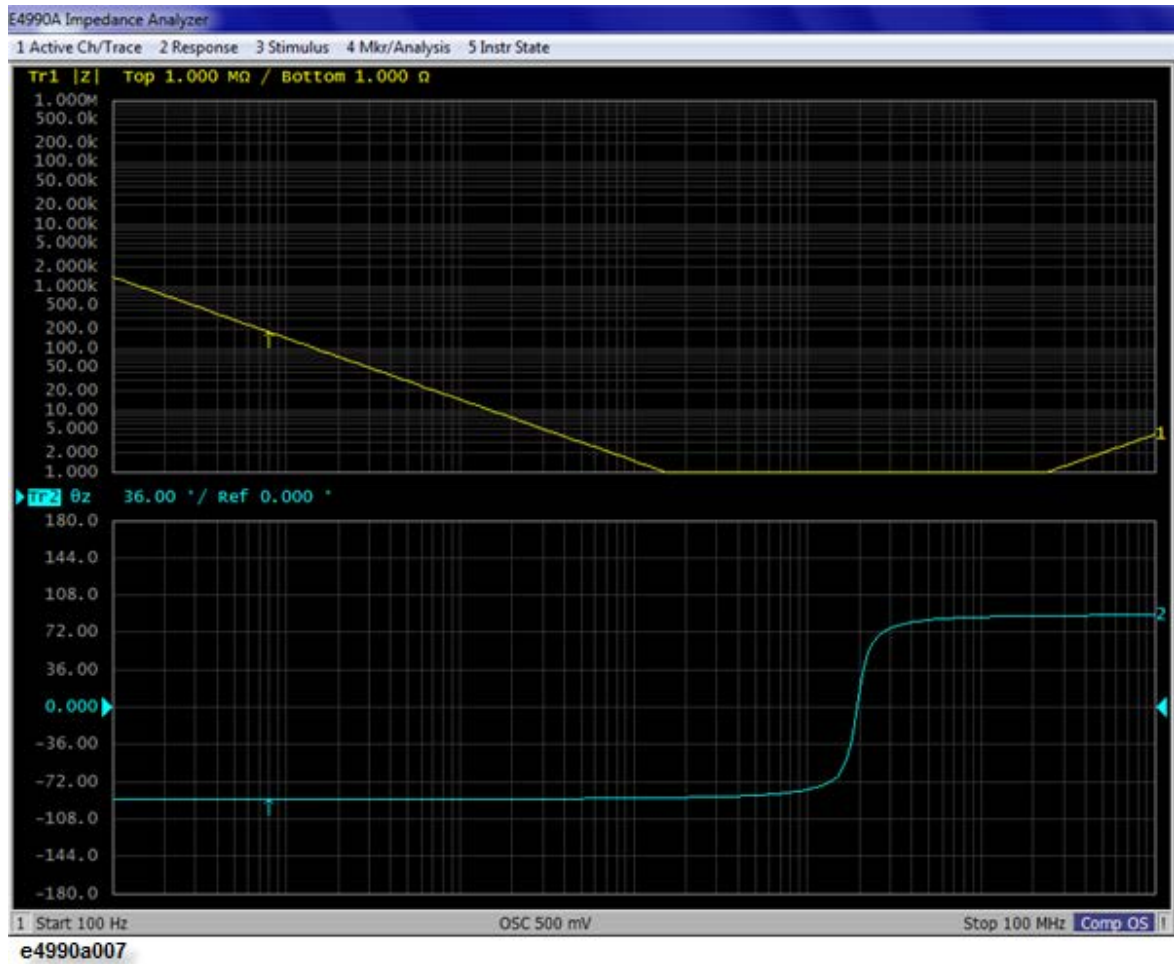

Auto-scale the Traces

1. Press the **Scale** > **Auto Scale All** to auto-scale both traces.
The result of applying auto-scale to all traces is shown below.



Results of Analysis

- [Determine the Self-resonance Frequency and Resonant Impedance](#)

[Other topics about Measurement Example](#)

Determine the Self-resonance Frequency and Resonant Impedance

1. Activate Trace 1 (you may use touch-screen or by toggling between **Trace Prev** and **Trace Next** key).
2. Press **Marker Search** key to display the **Marker Search** menu.
3. Select **Tracking** > **ON** to turn on the search tracking function. When this function is enabled, the instrument performs a search action upon completion of each sweep cycle.
4. Select **Min** to move the main marker to the minimum $|Z|$ value. Since the search tracking function is enabled, the instrument detects and moves the main marker to the minimum $|Z|$ value each time it has completed one sweep cycle.

You can determine the self-resonance frequency and resonant impedance by reading the sweep parameter (frequency) and measurement parameter values indicated by the main marker that appears in the upper-right area of the graph for Trace 1, as shown below.

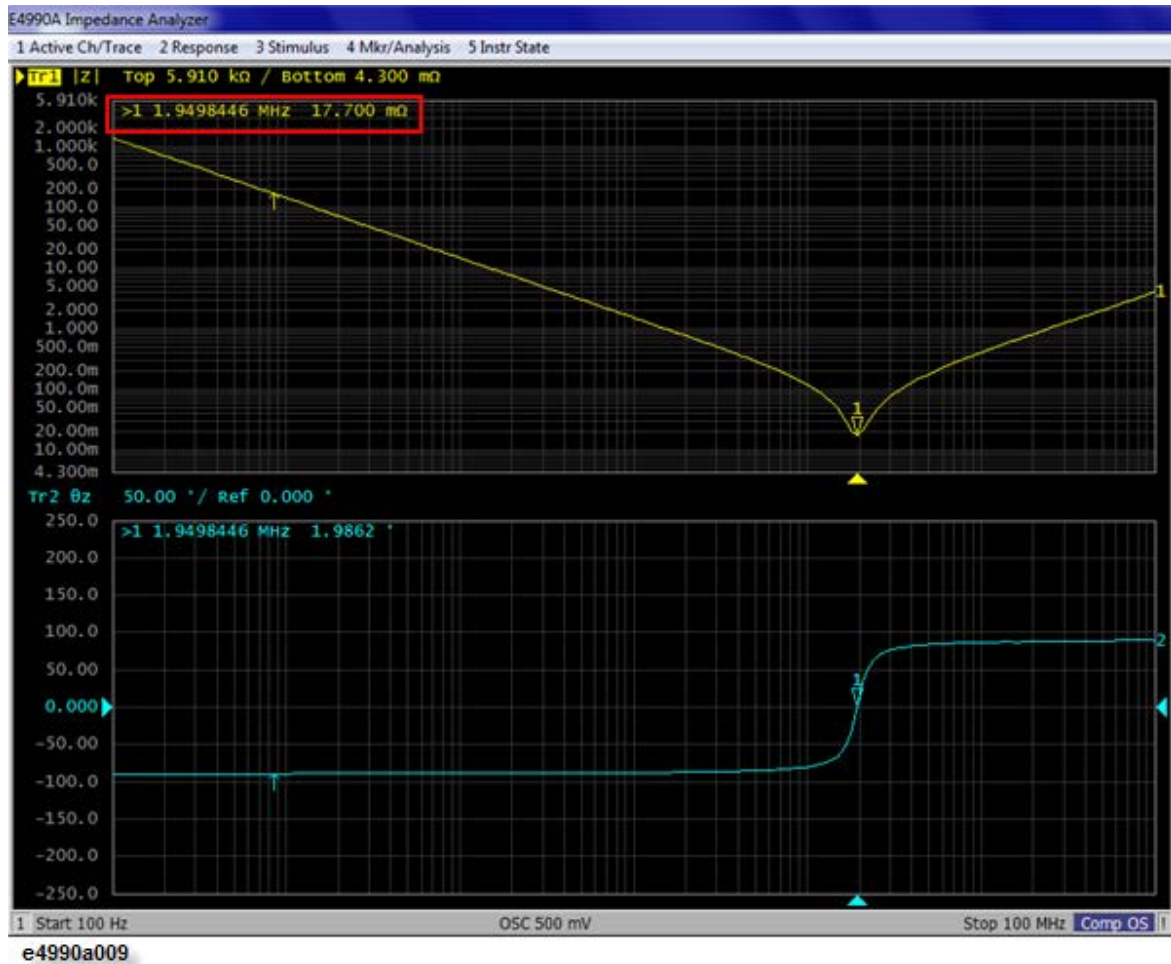

□

Softkey Shortcuts

The **Instr Setup** key provides quick access to the main softkeys required to setup and perform basic measurement, instead of accessing through different hardkeys.

Figure below shows the Instrument Setup softkeys and the alternate hardkeys that can be used to access the mentioned softkeys.

E4990A Impedance Analyzer Help

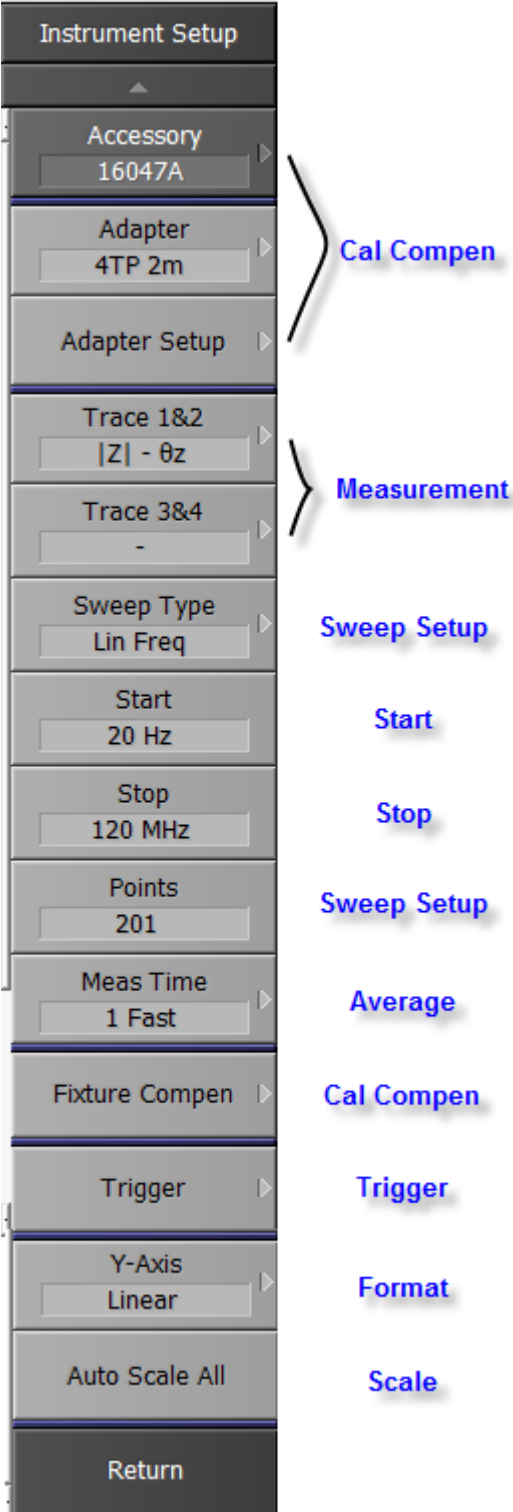

e4990a010

For example, **Accessory** softkey can be accessed by pressing **Cal** (Cal Compen) > **Accessory**, instead of **Instr Setup** > **Accessory**.

NOTE **Instr Setup** > **Trace 3&4** allows you to select either **OSC Monitor** or **DC Monitor** for both traces in parallel.

Measurement

Measurement

- [Preparation of Measurement Accessories](#)
- [Setting Measurement Conditions](#)
- [Calibration](#)
- [Setting Up the Display of Measurement Results](#)
- [Analysis and Processing of Result](#)
- [Outputting Data](#)

Preparation of Measurement Accessories

Preparation of Measurement Accessories

- [Selecting Accessories for Measurement](#)
- [Connecting the Accessories](#)
- [Adapter Setting](#)
- [Adapter Selection](#)
- [Adapter Setup](#)
 - [Adapter Setup Procedure for the 16048G and 16048H](#)
 - [Adapter Setup Procedure for the 16334A](#)
 - [Adapter Setup Procedure for the 16451B](#)
 - [Adapter Setup Procedure for the 42941A](#)
 - [Adapter Setup Procedure for the 42942A](#)

Selecting Accessories for Measurement

Select the appropriate accessories (test fixture, adapter, probe, cable, etc.) for your measurement in accordance with below table. Detailed specifications are described in catalogs or in the operation manual of each accessory.

[Guidelines for Selecting Accessories](#)

Type of Device	Condition	Accessory	Features of Accessory
----------------	-----------	-----------	-----------------------

	Arbitrary	None	-
Chip component	Frequency ≤ 40 MHz, Component size ≥ 1608	16034E	-
	Entire frequency range of E4990A, Component size ≥ 0603	16034G	-
	Entire frequency range of E4990A, Component size ≥ 1608	16034H	Can measure array-type components.
	Frequency ≤ 10 MHz, Component size ≥ 1608 , Low impedance device	16044A	Connected to the device by four terminals.
Lead component	Frequency ≤ 13 MHz	16047A	For axial and radial lead components.
	Frequency ≤ 40 MHz	16047D	For axial and radial lead components.
	Entire frequency range of E4990A	16047E	Equipped with screws for firmly fixing the fixture to the E4990A.
	Frequency ≤ 2 MHz, External dc bias up to ≤ 200 V	16065A	For axial and radial lead components. Equipped with safety cover.

E4990A Impedance Analyzer Help

	Frequency ≤ 100 kHz, Component terminal diameter ≤ 15 mm	16089A	Two Kelvin clips. Cable length: approx. 1 m.
	Frequency ≤ 100 kHz, Component terminal diameter ≤ 7.9 mm	16089B	Two Kelvin clips. Cable length: approx. 1 m.
	Frequency ≤ 100 kHz, Component terminal diameter ≤ 6 mm	16089E	Two Kelvin clips. Cable length: approx. 1 m.
	Frequency ≤ 100 kHz, IC pin diameter ≤ 1 mm	16089C	Two Kelvin clips. Cable length: approx. 1 m.
	Frequency ≤ 100 kHz	16089D	Four alligator clips. Cable length: approx. 1 m.
	Entire frequency range of E4990A	16092A	For both chip and lead components.
Chip component	Entire frequency range of E4990A, Component size ≥ 1608	16192A	Connected to both sides of the component.
	Entire frequency range of E4990A,	16194A	Connected to the component's

	Component size ≥ 1608		bottom face.
	Entire frequency range of E4990A, Component size ≥ 1608	16196A	Connected to both sides of the component.
	Entire frequency range of E4990A, Component size ≥ 1608	16196B	Connected to both sides of the component.
	Entire frequency range of E4990A, Component size ≥ 1608	16196C	Connected to both sides of the component.
	Entire frequency range of E4990A, Component size ≥ 1608	16196D	Connected to both sides of the component.
	Entire frequency range of E4990A, Component size ≥ 1608	16197A	Connected to the component's bottom face.
	Frequency ≤ 15 MHz	16334A	Tweezers type. Cable length: approx. 1 m.
Circuit	Entire frequency range of E4990A	42941A and probe adapter ¹	Probe type.
General	Cable extension	42941A, coaxial cable, and test fixture	42941A: approx. 1.5 m.

1. Furnished with the 42941A Impedance Probe Kit.

NOTE The 16085B Terminal Adapter cannot be used in place of the 42942A Terminal Adapter. The 16048A BNC 1 m Cable, the 16048B SMC 1 m Cable, the 16048D BNC 2 m Cable, or the 16048E BNC 4 m Cable cannot be used in place of the 16048G or 16048H.

Connecting the Accessories

1. Connect the measurement accessories to the E4990A.
2. Press the standby switch on the front panel of the E4990A to turn it on.
3. Press **Cal** > **Accessory** or **Instr Setup** > **Accessory** to select the accessories for measurement.

NOTE Whenever you connect accessories to or disconnect accessories from the E4990A, you must turn off the dc bias (**Sweep Setup** > **DC Bias State**). If this step is not taken, the dc bias may destroy the device.

When you connect or disconnect accessories with the E4990A turned on, error messages such as "Z measurement overload" may be displayed on the LCD screen. However, this does not cause any special problem. To turn off the messages, press **Entry Off**.

Adapter Setting

You must ensure that the adapter setting is properly set after you finish connecting accessories to the four-terminal pair port of the E4990A and before you start measurement. If required, change it to the correct adapter setting. The adapter setting includes adapter selection and the data acquisition process, which is called adapter setup. The following table lists the device connections and corresponding adapter settings.

Device Connections and Adapter Settings

Device Connection	Accessory	Adapter Selection	Adapter Setup (data measurement) (√: required; blank: not required)			
			Phase *1	OPEN	SHORT	LOAD
A. Connect a direct connection	16034E 16034G	No Adapter				

<p>type test fixture to the four-terminal pair port of the E4990A and connect the device to the fixture contacts.</p>	<p>16034H 16044A 16047A 16047D 16047E 16065A *2 16089A *2 16089B *2 16089C *2 16089D *2 16089E *2</p>	<p>(NONE)</p>				
<p>B. Extend the four-terminal pair port of the E4990A with a 1-meter-long four-terminal pair configuration and connect the device.</p>	<p>16048G and test fixture 16048G and 16452A</p>	<p>Four-terminal pair, 1 meter (4TP 1M)</p>	<p>√</p>			<p>√</p>
	<p>16334A *3</p>	<p>Four-terminal pair, 1 meter (4TP 1M)</p>	<p>√</p>			
	<p>16451B *3</p>	<p>Four-terminal pair, 1 meter (4TP 1M)</p>	<p>√</p>			
<p>C. Extend the four-terminal pair port of the E4990A with a 2-meter-long four-</p>	<p>16048H and test fixture 16048H and 16452A</p>	<p>Four-terminal pair, 2 meters (4TP 2M)</p>	<p>√</p>			<p>√</p>

E4990A Impedance Analyzer Help

terminal pair configuration and connect the device.						
D. Connect the 42942A directly to the four-terminal pair port of the E4990A, connect a dedicated test fixture to the 7mm port, and then connect the device to the fixture contacts. (Only for Option 120)	42942A and 16092A 42942A and 16192A 42942A and 16454A	42942A Terminal Adapter (7mm 42942A)	√	√	√	√
E. Connect the 42942A directly to the four-terminal pair port of the E4990A, connect a coaxial cable to the 7-mm port, connect a test fixture, and then connect the device to the fixture contacts. (Only for	42942A, coaxial cable, and test fixture	42942A Terminal Adapter (42942A Extension)	√	√	√	√

Option 120)						
<p>F. Connect the 42941A directly to the four-terminal pair port of the E4990A, connect a dedicated probe adapter to the SMA port, and then connect the device to the adapter contacts. (Only for Option 120)</p>	42941A and probe adapter	42941A Impedance Probe (PROBE 42941A)	√	√	√	√
<p>G. Connect the 42941A directly to the four-terminal pair port of the E4990A, connect a coaxial cable to the SMA port, connect a test fixture, and then connect the device to the fixture contacts. (Only for Option 120)</p>	42941A, coaxial cable, and test fixture	42941A Impedance Probe (42941A Extension)	√	√	√	√

- *1. Phase compensation.
- *2. Although it has a cable, it is considered a direct-connection-type test fixture.
- *3. Clear the adapter setup before you start the fixture (**System** > **Service Menu** > **Clear Adapter Setup**)

Adapter Selection

The adapter selection setting must be confirmed before measurement in accordance with the connection status of each accessory. If necessary, it must be changed to the correct setting.

1. Press **Cal** > **Adapter**.
2. Select the corresponding adapter selection from the following:

Adapter Selection	Softkey Label
No Adapter	NONE
Four-terminal pair, 1 meter	4TP 1M
Four-terminal pair, 2 meter	4TP 2M
42942A Terminal Adapter	7mm 42942A
42942A Terminal Adapter and extension cable	42942A Extension
42941A Impedance Probe	Probe 42941A
42941A Impedance Probe and extension cable	42941A Extension

NOTE Adapter selection status can also be confirmed through the display of the instrument status area.

NOTE The 42941A and 42942A can be selected only when the E4990A is equipped with option 120.

Adapter Setup

Adapter Setup

The adapter setup is a process used to acquire the setup data of the adapter selected by the [Adapter Selection](#). The adapter setup is normally

performed when using the following accessories with the E4990A for the first time after it is delivered. The adapter setup should be performed again when the accessory is changed. Even if the different accessory with the same model number is placed, the adapter setup should be performed again in order to compensate the electrical length difference.

- 16048G 1m Port Extension Cable
- 16048H 2m Port Extension Cable
- 16334A Test Fixture (Tweezers Contacts)
- 16451B Dielectric Test Fixture
- 42942A Terminal Adapter
- 42941A Impedance Probe Kit

NOTE Adapter setup should be performed at an ambient temperature as close as possible to the temperature in which the device measurement will actually be made.

If the ambient temperature for your measurement is outside the range of $\pm 5^{\circ}\text{C}$ from the adapter setup temperature, it is recommended that you perform adapter setup again at the appropriate temperature.

It takes a few minutes to complete each setup data measurement.

For each adapter setup procedure, refer to:

- [Adapter Setup Procedure for the 16048G and 16048H](#)
- [Adapter Setup Procedure for the 16334A](#)
- [Adapter Setup Procedure for the 16451B](#)
- [Adapter Setup Procedure for the 42942A](#)
- [Adapter Setup Procedure for the 42941A](#)

NOTE When you select “No Adapter” (**NONE**) in adapter selection, adapter setup cannot be performed.

Adapter setup data can be obtained and saved for each adapter selection.

Adapter setting (adapter selection and adapter setup data) is not affected by turning on/of the E4990A or by pressing the **Preset** to initialize the instrument settings. Press **System** > **Meas Setup** > **Clear Adapter Setup** to reset the adapter setup setting.

Adapter Setup Procedure for the 16048G and 16048H

E4990A Impedance Analyzer Help

When you use the 16048G 1m cable or 16048H 2m cable with another accessory, only perform the adapter setup for the 16048G or 16048H.

1. Make sure that the 16048G or 16048H is correctly connected to the four-terminal pair port of the E4990A.
2. More than 30 minutes warm-up time is required after turning on the E4990A.
3. Make the correct accessory selection in accordance with [Selecting Accessories for Measurement](#).
4. Press **Preset**.
5. Press **Cal** > **Adapter** > **4TP 1m** for 16048G or **4TP 2m** for 16048H.
6. Press **Cal** > **Adapter Setup**.
7. Connect the LCUR and LPOT terminals on the 16048G or 16048H to the HPOT and HCUR terminals of the 100 Ω Resistor (furnished with the E4990A, Part Number: E4990-61001). Other terminals should remain open.

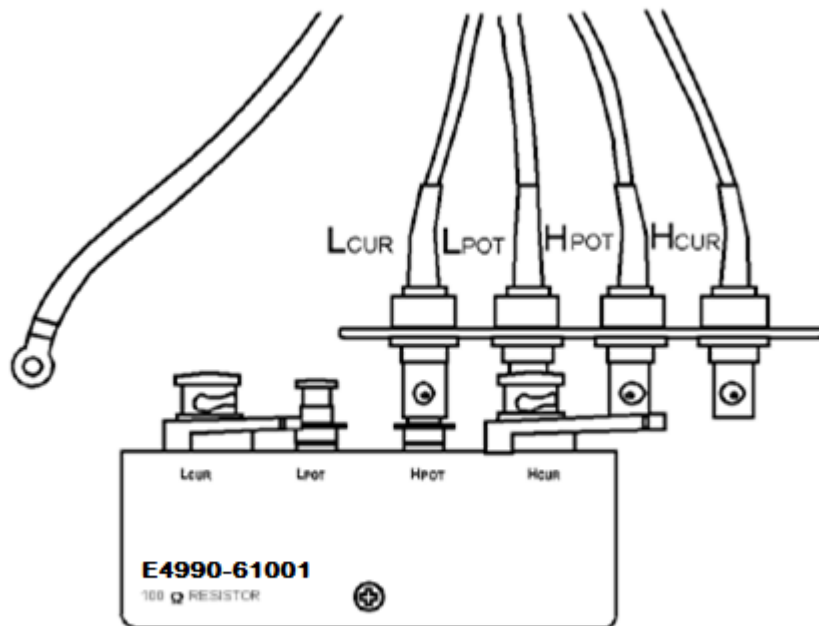

e4990a057

8. Click **Phase** to start the phase compensation data measurement. When the phase compensation data measurement is completed, the softkey label changes to **Phase [Done]**.
9. Click **Save Phase**.

10. Connect the LCUR, LPOT, HPOT, and HCUR terminals on the 16048G or 16048H to the LCUR, LPOT, HPOT and HCUR terminals of the 100 Ω Resistor.

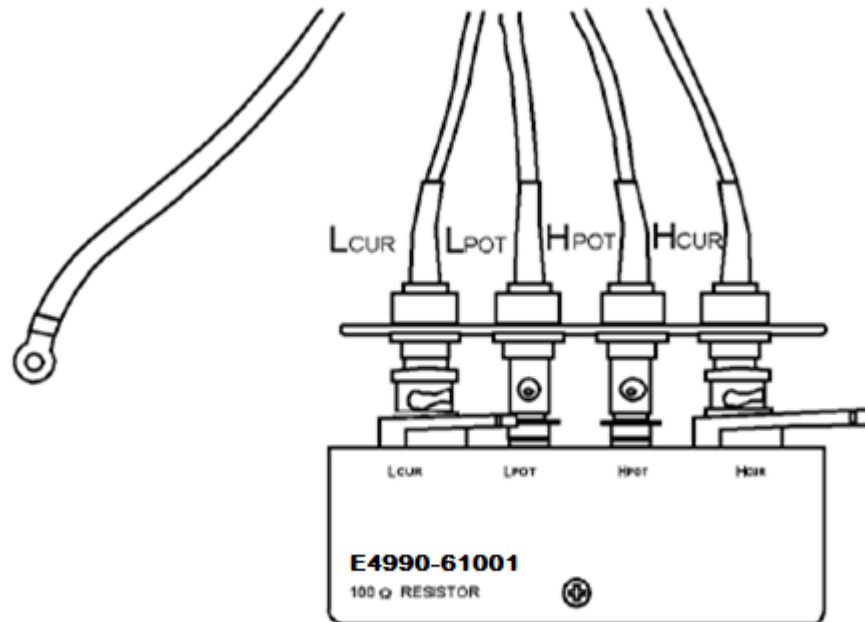

e4990a058

11. Click **E4990-61001** to start the measurement.
12. When the load data measurement is completed, the softkey label changes to **E4990-61001 [Done]**.
13. Click **Save Impedance** to start calculating the adapter setup data from the measured phase compensation and load data. The adapter setup data is automatically saved to the E4990A.

NOTE

Click **Cancel** to cancel the adapter setup process. If the adapter setup process is cancelled, the previously obtained data is saved as the available adapter setup data.

Adapter Setup Procedure for the 16334A

Perform the adapter setup for the 16334A Tweezers Type Test Fixture in accordance with the following procedure:

1. Make sure that the 16334A is correctly connected to the four-terminal pair port of the E4990A. The 16334A must be directly connected to the four-terminal pair port of the E4990A.
2. More than 30 minutes warm-up time is required after turning on the E4990A.

3. Press **Preset**.
4. Press **Cal** > **Accessory** > **16334 (15 MHz max)**.
5. Press **Cal** > **Adapter Setup**.
6. Put the device contacts of the 16334A into the OPEN condition. Refer to the operation manual of the 16334A for instructions on switching to the OPEN condition.
7. Click **Phase** to start the phase compensation data measurement. When the phase compensation data measurement is completed, the softkey label changes to **Phase [Done]**.
8. Click **Save Impedance** to start calculating the adapter setup data from the measured phase compensation and load data. The adapter setup data is automatically saved to the E4990A.

NOTE

Click **Cancel** to cancel the adapter setup process. If the adapter setup process is cancelled, the previously obtained data is saved as the available adapter setup data.

NOTE

The open, short and load [fixture compensations](#) are recommended.

Adapter Setup Procedure for the 16451B

Perform the adapter setup for the 16451B Dielectric Test Fixture in accordance with the following procedure:

1. Make sure that the 16451B is correctly connected to the four-terminal pair port of the E4990A.
2. More than 30 minutes warm-up time is required after turning on the E4990A.
3. Press **Preset**.
4. Press **System** > **Service Menu** > **Clear Adapter Setup**.
5. Press **Cal** > **Accessory** > **Arbitrary**.
6. Press **Cal** > **Adapter** > **4TP 1m**.
7. Press **Cal** > **Adapter Setup**.
8. Put the device contacts of the 16451B into the OPEN condition. Refer to the operation manual of the 16451B for instructions on switching to the OPEN condition.
9. Click **Phase** to start the phase compensation data measurement. When the phase compensation data measurement is completed, the softkey label changes to **Phase [Done]**.

NOTE

Click **Cancel** to cancel the adapter setup process. If the adapter setup process is cancelled, the previously obtained data is saved as the available adapter setup data.

Adapter Setup Procedure for the 42942A

Perform the adapter setup for the 42942A Terminal Adapter in accordance with the following procedure.

1. Make sure that the 42942A is correctly connected to the four-terminal pair port of the E4990A.
2. More than 30 minutes warm-up time is required after turning on the E4990A.
3. Make the correct accessory selection in accordance with [Selecting Accessories for Measurement](#).
4. Press **Preset**.
5. Press **Cal** > **Adapter** > **7mm 42942A**. When you extend the cable, select **42942A Extension**.
6. Connect OPEN (0 S) to the 7-mm port of the 42942A (the OPEN standard is furnished with the 42942A Terminal Adapter).

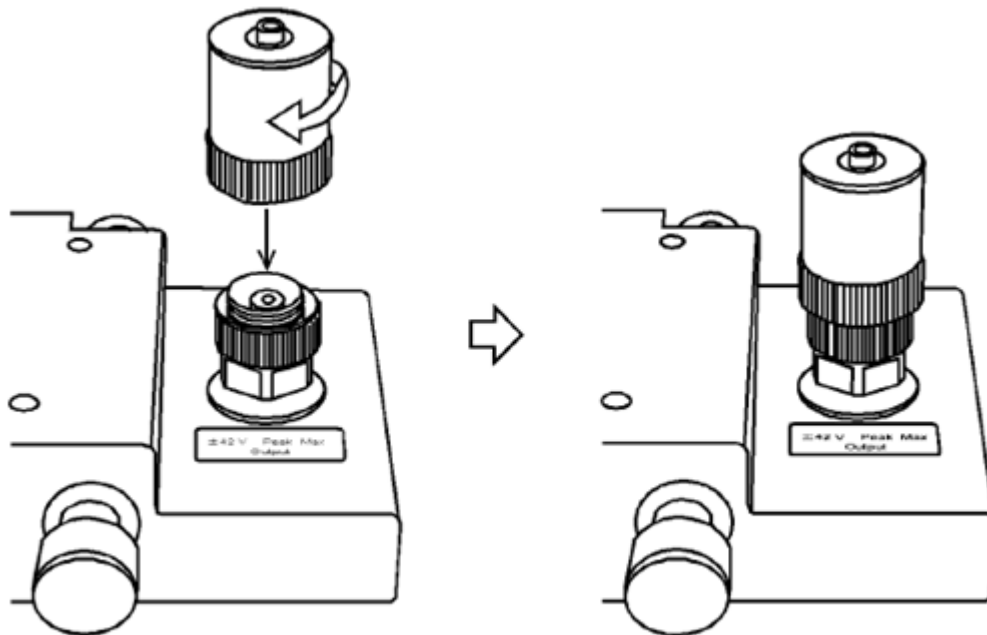

e4990a059

6. Click **Phase** to start the phase compensation data measurement. When the phase compensation data measurement is completed, the softkey label changes to **Phase [Done]**.

E4990A Impedance Analyzer Help

7. With the OPEN (0 S) standard connected to the 7-mm port, click **OPEN** to start the open data measurement. When the load data measurement is completed, the softkey label changes to **Open [Done]**.
8. Remove the OPEN (0 S) standard from the 7-mm port of the 42942A. Then connect the SHORT (0 Ω) standard to the 7-mm port (the SHORT standard is furnished with the 42942A Terminal Adapter).

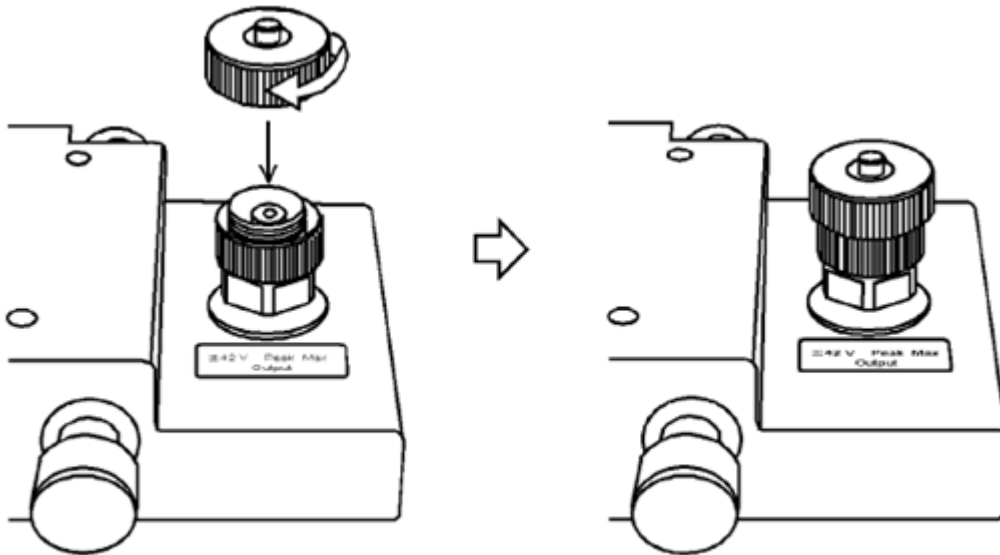

e4990a060

9. Click **Short** to start the short data measurement. When the short data measurement is completed, the softkey label changes to **Short [Done]**.
10. Remove the SHORT (0 Ω) standard from the 7-mm port of the 42942A. Then connect the LOAD (50 Ω) standard to the 7-mm port (the LOAD standard is furnished with the 42942A Terminal Adapter).

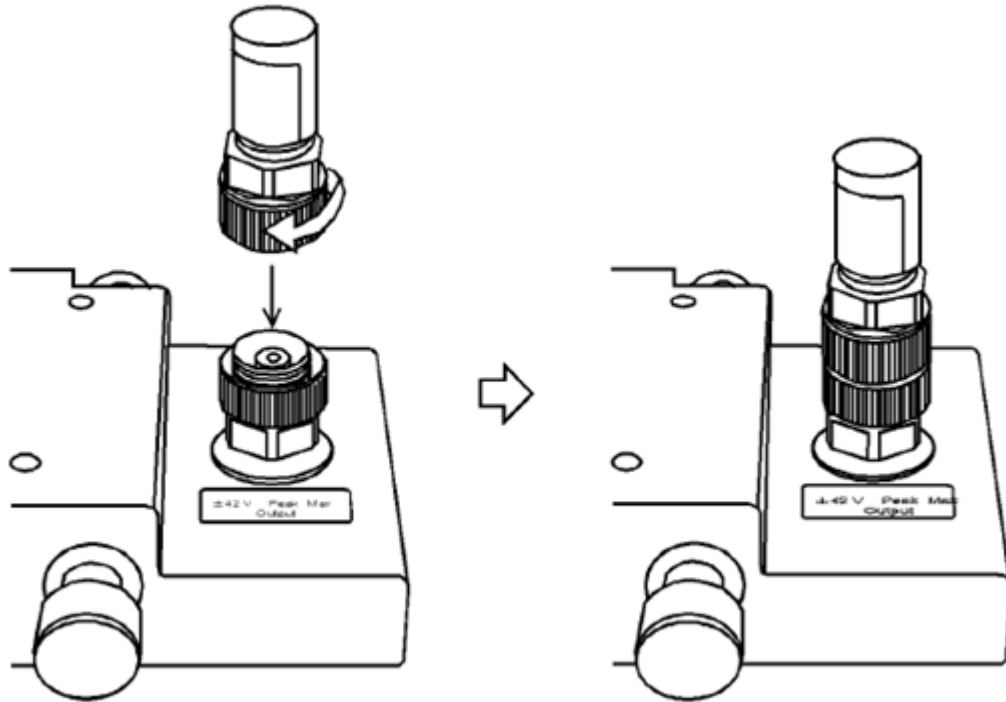

e4990a061

11. Click **Load** to start the load data measurement. When the load data measurement is completed, the softkey label changes to **Load [Done]**.
12. Click **Save Impedance** to start calculating the adapter setup data from the measured OPEN, SHORT, and LOAD data. The adapter setup data is automatically saved in the E4990A.

NOTE

Click **Cancel** to cancel the adapter setup process. If the adapter setup process is canceled, the previously obtained data is saved as the available adapter setup data.

Adapter Setup Procedure for the 42941A

Perform the adapter setup for the 42941A Impedance Probe in accordance with the following procedure.

1. Make sure that the 42941A is correctly connected to the four-terminal pair port of the E4990A.
2. More than 30 minutes warm-up time is required after turning on the E4990A.
3. Press **Preset**.
4. Press **Cal** > **Accessory** > **42941A**.

5. Confirm that the **42941A** is selected for **Cal** > **Adapter**. When you extend the cable, select **42941A Extension**.
6. Leave the 3.5-mm port of the 42941A open (no connection). There is no OPEN standard for the 42941A.
7. Click **Phase** to start the phase compensation data measurement. When the phase compensation data measurement is completed, the softkey label changes to **Phase [Done]**.
8. With nothing connected to the 3.5-mm port, click **Open** to start open data measurement. When the load data measurement is completed, the softkey label changes to **Open [Done]**.
9. Connect the SHORT (0 Ω , HRM 504) to the 3.5-mm port (the SHORT is furnished with the 42941A Impedance Probe).
10. Click **Short** to start the short data measurement. When the short data measurement is completed, the softkey label changes to **Short [Done]**.
11. Remove the SHORT (0 Ω , HRM 504) from the 3.5-mm port of the 42941A. Then connect the LOAD (50 Ω , HRM 601) to the 3.5-mm port (the LOAD is furnished with the 42941A Impedance Probe).
12. Click **Load** to start the load data measurement. When the load data measurement is completed, the softkey label changes to **Load [Done]**.
13. Click **Save Impedance** to start calculating the adapter setup data from the measured phase compensation, OPEN, SHORT, and LOAD data. The adapter setup data is automatically saved in the E4990A.

NOTE

Press the **cancel** key to cancel the adapter setup process. If the adapter setup process is canceled, the previously obtained data is saved as the available adapter setup data.

Setting Measurement Conditions

Setting Measurement Conditions

This chapter explains how to set up the measurement conditions for the Keysight E4990A Impedance Analyzer, including the measurement signal and sweep.

- [Initializing Parameters](#)
- [Setting Channels and Traces](#)
- [Selecting Sweep Parameter](#)

- [Setting Source](#)
- [Setting Trigger](#)

Initializing Parameters

Initializing Parameters

The E4990A has three different initial settings as shown below.

Initial Setting	Restore method
Preset state	<p>Press Preset on the front panel, one message will prompt as below and then click OK.</p> <p>"Factory preset (default) DOES NOT change "Adapter" and "Accessory" type from the current setting.</p> <p>User preset DOES change "Adapter" and "Accessory" type to what you saved as the "UserPres" file previously.</p> <p>Check the menu under [Cal] key whether proper type is selected for your new measurements.</p> <p>You can change Factory/User preset type selection, and choose to show or not to show this dialog under [System] > {Misc Setup} > {Preset Setup} menu."</p> <p>or</p> <p>Execute the :SYST:PRES command.</p>
*RST state	Execute the *RST command.
Factory default setting	E4990A factory (default) settings.

The user can set items to be preset freely. For more information, see [Setting the user preset function](#).

[Other topics about Setting Measurement Conditions](#)

Setting Channels and Traces

- [Overview of Channel and Trace](#)
- [Setting Channel Display \(Layout of Channels\)](#)

- [Changing Active Channel](#)
- [Setting Trace Display](#)
- [Changing Active Trace](#)

[Other topics about Setting Measurement Conditions](#)

Overview of Channel and Trace

The E4990A allows you to setup multiple channels to perform measurement under different stimulus conditions.

As multiple traces (measurement parameters) can be displayed for each channel, no feature is provided to link the stimulus conditions between channels, and each channel is always independent of the others. In other words, you need to set the measurement conditions and execute calibration for each channel you use for measurement.

When you set items whose setting target is channels/traces (refer to [Parameter setting for each setup item](#)), the target is the selected (active) channel/trace. You can specify only the displayed channels/traces as active channels/traces. Therefore, set the display of channels/traces before setting the measurement conditions.

Setting Parameter for each Setup Item (Analyzer, Channel, Trace)

The following table lists the setting parameters and indicates the setup item (analyzer, channel, or trace) that each parameter controls along with the applicable setup key(s).

Parameter	Controlled Setup Items			Setup Key(s)
	Analyzer	Channel	Trace	
Stimulus Settings				
Sweep range		x		Start, Stop, Center, Span
OSC Level, CW frequency		x		Sweep Setup > OSC level
Sweep time/Sweep delay time		x		Sweep Setup > Sweep Time, Sweep Delay
Number of points		x		Sweep Setup >

				Points
Segment sweep		x		Sweep Setup > Sweep Type, Edit Segment Table, Segment Display
DC Bias		x		Sweep Setup > Sweep Type
Trigger Settings				
Trigger mode		x		Trigger > Hold/Single/Continuous
	x			Hold All Channels/Continuous Disp Channels
Trigger source, Trigger Event, Trigger Scope	x			Trigger > Trigger Source, Trigger Event, Trigger Scope
Trigger	x			Trigger > Restart/Trigger
Ext Trigger Input, Trigger Delay	x			Trigger > Ext Trig Input, Trigger Delay
Ext Trigger Output, Polarity, Position, Pulse Width	x			Trigger > Ext Trig Output, Polarity, Position, Pulse Width
Response Settings				
Measurement parameter			x	Meas
Data format			x	Format
Scale			x	Scale

E4990A Impedance Analyzer Help

Memory trace and data math			x	Display > Display/Data-> Mem/Data Math
Equation Editor			x	Display > Equation Editor/Equation (ON/OFF)
Window title		x		Display > Edit Title Label/ Title Label (ON/OFF)
Graticule label in rectangular form		x		Display > Graticule Label (ON/OFF)
Color inversion	x			Display > Invert Color
Frequency display	x			Display > Frequency (ON/OFF)
Display update	x			Display > Update (ON/OFF)
Averaging		x		Avg > Averaging Restart/ Avg Factor/Averaging (ON/OFF)
Averaging Trigger	x			Avg > Avg Trigger (ON/OFF)
Calibration/Fixture Compensation		x		Cal
Marker			x	Marker, Marker Search, Marker Fctn
Marker Table	x			Marker Fctn > Marker Table

Analysis				
Equivalent Circuit			x	Analysis > Equivalent Circuit
Limit Test			x	Analysis > Limit Test
Saving and recalling data	x			Save/Recall
Macro	x			Macro Setup, Macro Run, Macro Break
System				
Printing/Saving display Screen/Beeper/GPIB settings/Network Settings/Date & Time/Key Lock/Backlight/Firmware Revision/Service menu	x			System
Preset	x			Preset

Number of Channels/Traces

The number of channels and the number of traces are 4. The maximum number of points is 1601.

Setting Channel Display (Layout of Channels)

The measurement result for each channel is displayed in its dedicated window (channel window). You cannot have a single window to display the measurement results from more than one channel. This means that the setting of the window layout determines the number of channels displayed on screen.

NOTE

The execution of measurement for each channel does not depend on how the channel is displayed (channels that are not displayed can be measured). For information on executing measurement for each channel (trigger mode and trigger source).

The procedure for setting the window layout is as follows:

1. Press **Display > Allocate Channels**.

2. Press the desired softkey to select the window layout.

Changing Active Channel

The active channel is the one whose settings can currently be changed. The window frame of the active channel is displayed brighter than the window frames of the other channels. To change the settings specific to a certain channel, you must first activate the channel.

To change the active channel, use the following hardkeys:

Hardkey	Function
Channel Next	Change the active channel to the next channel with the larger channel number.
Channel Prev	Change the active channel to the previous channel with the smaller channel number.

Setting Trace Display

Setting the number of traces

Depending on the measurement parameters of the traces displayed for each channel, the sweep necessary for each channel is executed.

You specify the trace display by setting the number of traces (upper limit of displayed trace numbers). For example, if you set the number of traces to 3, traces 1 through 3 are displayed.

The procedure for setting the number of traces is as follows:

1. Press **Channel Next** (or **Channel Prev**) to select the channel for which you want to set the number of traces.
2. Press **Display > Number of Traces**.
3. Press the desired softkey to set the number of traces.

Setting trace layout (graph layout)

Traces are laid out and displayed in the order of the trace number from graph 1 according to the graph layout in the channel window.

You can select the graph layout from the windows layout.

If the number of traces is less than the number of graphs, nothing is displayed in the remaining area. If the number of traces you set exceeds the number of graphs, excess traces are superimposed from the first

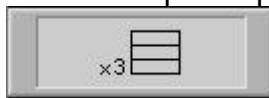

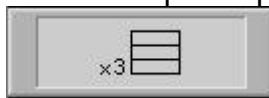
graph. For example, if you select  as the graph layout and set the number of traces to 4, graph 1 (Gr1 in [Graph layout](#)) display traces 1 and 2, respectively, by superimposing, and graph 2 (Gr2 in [Graph](#)

[layout](#)) and graph 3 (Gr3 in [Graph layout](#)) displays trace 2 and trace 4 as shown in the figure below.

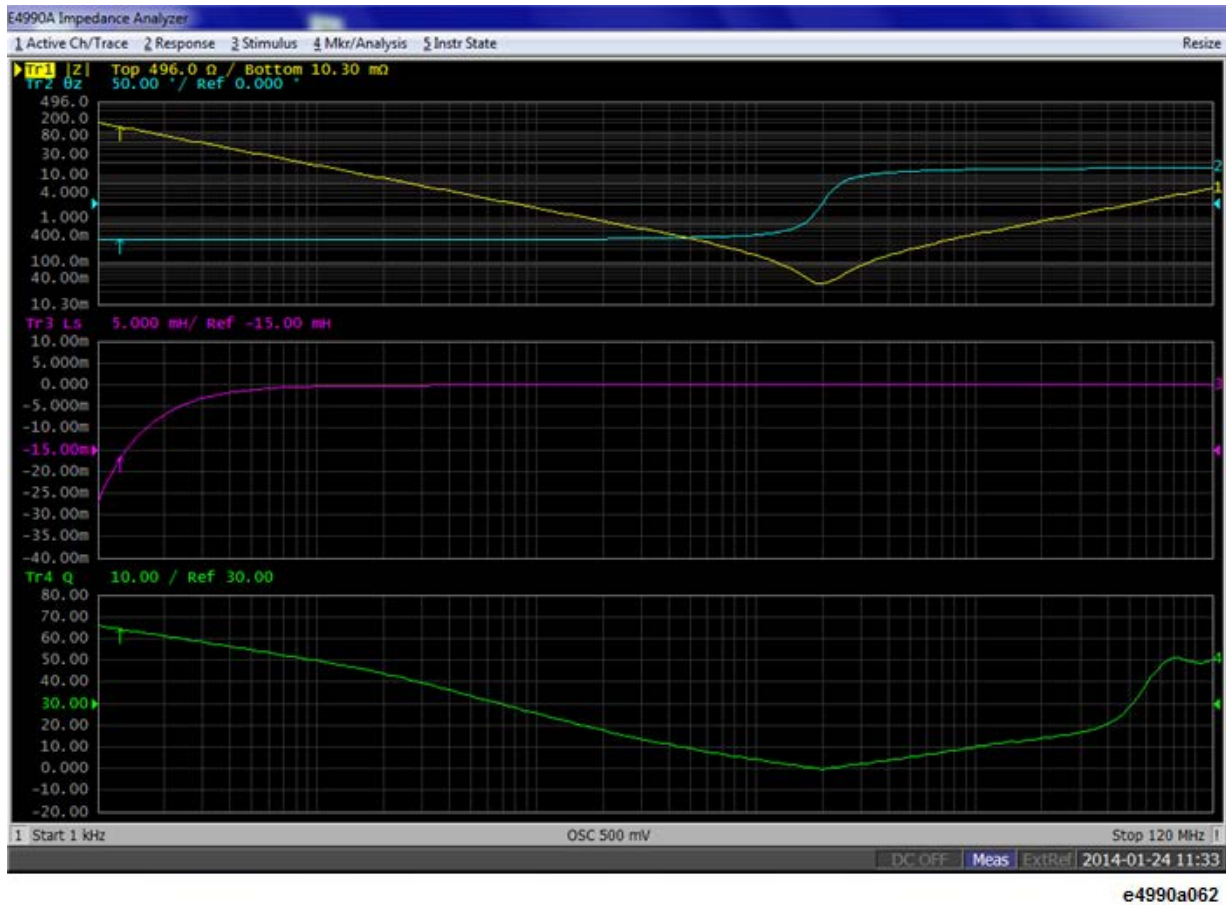

The procedure for setting the graph layout is as follows:

1. Press **Channel Next** (or **Channel Prev**) to select the channel for which you want to set the graph layout.
2. Press **Display** > **Allocate Traces**.
3. Press the desired softkey to select the graph layout shown below.

Graph Layout

E4990A Impedance Analyzer Help

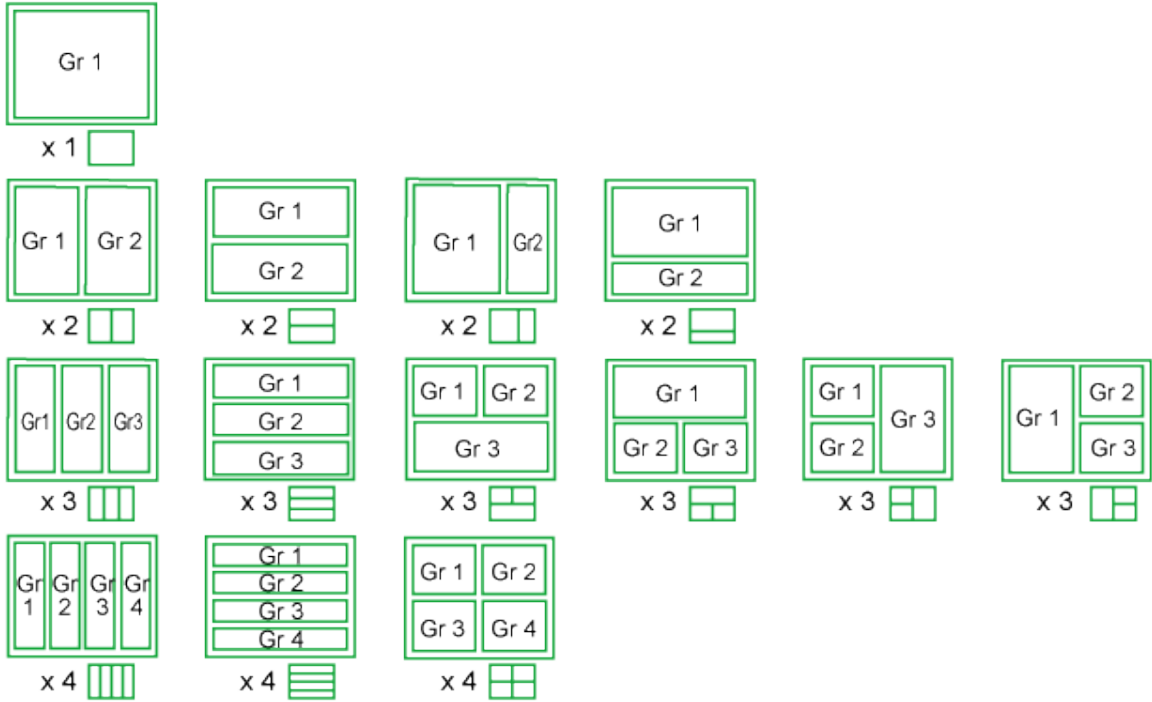

e5061b026

Changing Active Trace

The active trace is the one whose settings can currently be changed. The trace name on the screen (for example, Tr2) of the current active trace is highlighted and indicated with ► to the left. To change the settings specific to a certain trace, you must first activate the trace.

To select the active trace, use the following hardkeys:

Hardkey	Function
Trace Next	Change the active trace to the next trace with the larger trace number.
Trace Prev	Change the active trace to the previous trace with the smaller trace number.

Selecting Sweep Parameter

- [Selecting Sweep Type](#)
- [Setting Sweep Range](#)

- [Using Time as Sweep Parameter \(Zero Span Sweep\)](#)
- [Setting Number of Points \(NOP\)](#)
- [Selecting Sweep Direction](#)
- [Setting Time Delay for Measurement](#)
- [Setting Measurement Time](#)
- [Averaging Between Sweeps \(Sweep-to-Sweep Averaging\)](#)
- [Making Sweep Averaging Measurement with Single Trigger](#)
- [Averaging for Each Measurement Point \(Point Averaging\)](#)

[Other topics about Setting Measurement Conditions](#)

Selecting Sweep Type

To select the sweep type:

1. Press **Sweep Setup** > **Sweep Type**.
2. Press the desired softkey to select the sweep type: **Lin Freq** | **Log Freq** | **Segment** | **OSC Level** | **DC Bias** | **Log DC Bias**.

NOTE When selecting the **OSC Level**, oscillator level as a sweep parameter, follow the steps shown in ["Selecting Unit for Oscillator Level \(Voltage or Current\)"](#) to select sweeping by voltage or current level.

When selecting the dc bias as a sweep parameter, proceed to the setting shown in [Setting and Applying dc Bias](#).

See [Using Time as Sweep Parameter \(Zero Span Sweep\)](#) for the measurement with time as a sweep parameter (zero span measurement).

The sweep parameter is set for all traces. It is not necessary to select an active trace or to verify the current selection before setting the parameter.

Setting Sweep Range

Sweep range can be set by specifying either start and stop values or center and span values.

NOTE The measurement range can be set to trace A and trace B in common. It is not necessary to select an active trace or to verify the current selection before setting the range.

Start/Stop/Center/Span, Marker Fctn > Marker-> Start/Stop/Center

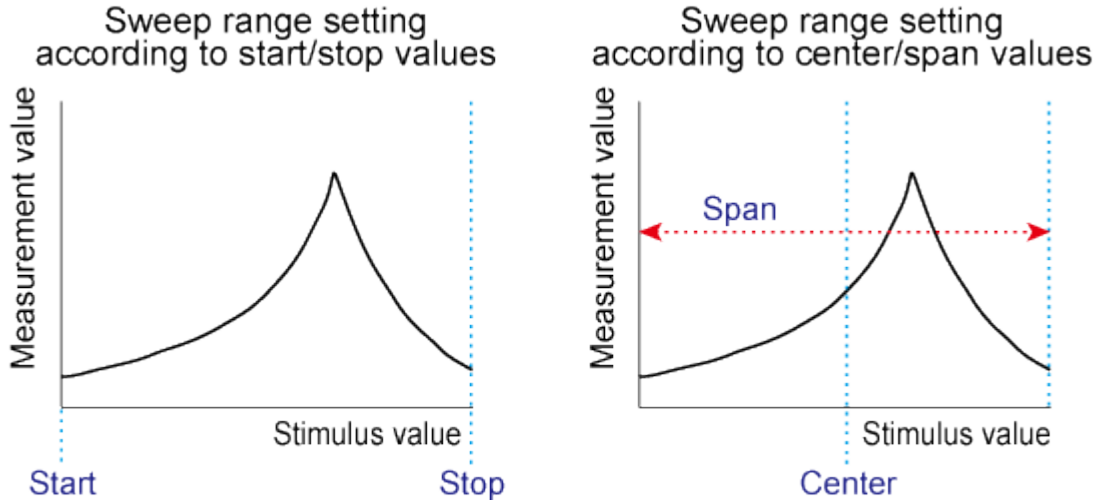

e5071c443

Setting the Sweep Range with the Start and Stop Values

1. Press **Start**, then input the start value.
2. Press **Stop**, then input the stop value.

NOTE The sweep start value cannot be greater than the sweep stop value. Sweep with decreasing frequency can be possible by setting a sweep range with increasing frequency and then specifying a downward sweep direction. Refer to [Selecting Sweep Direction](#) to specify the sweep direction.

Setting the Sweep Range with the Center and Span Values

1. Press **Center**, then input the center value.
2. Press **Span**, then input the span value.

Setting Sweep Range Using the Marker

1. Press **Marker Fctn**, then input the center value.
2. Click the softkey that corresponds to each value.

Softkey	Function
Marker -> Start	Sets the lowest value to the stimulus value of the active marker on the currently active trace.
Marker -> Stop	Sets the highest value to the stimulus value of the active marker on the currently active trace.
Marker -> Center	Sets the center value to the stimulus value of the active marker on the currently active trace.

NOTE

If the reference marker is on and the stimulus value of the active marker is expressed by a value relative to the reference marker, the absolute stimulus value will be used to set the new sweep range.

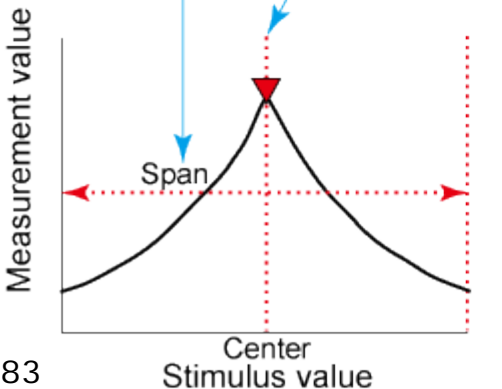
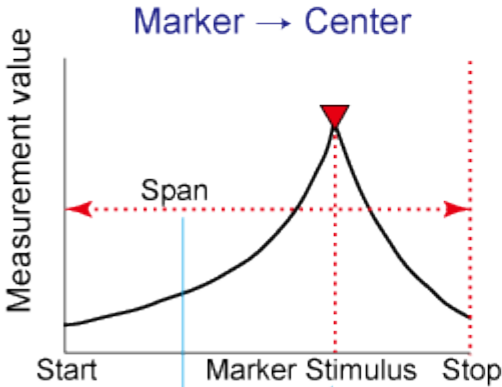
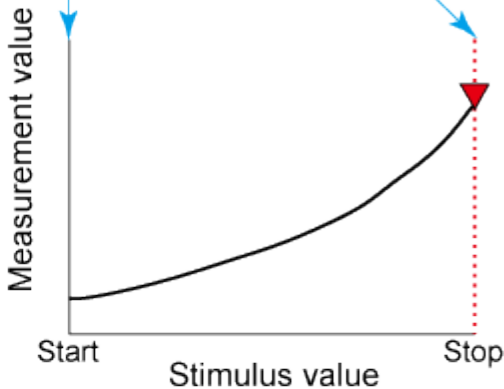
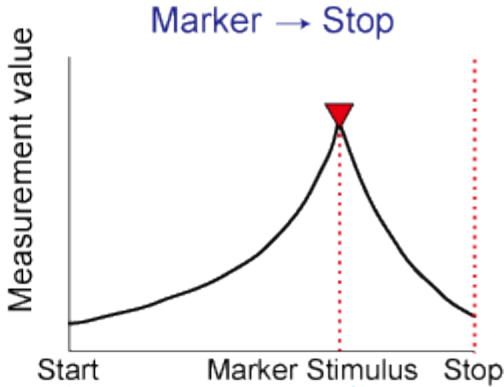
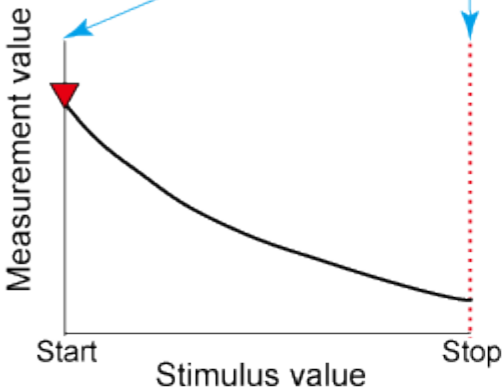
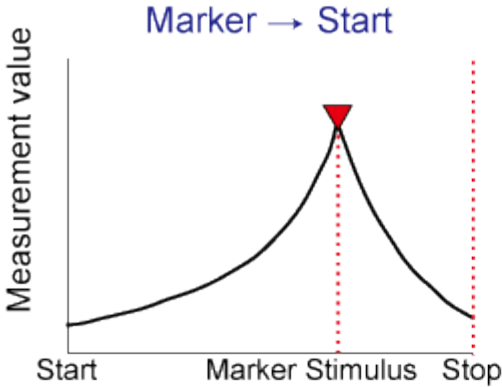

Softkey	Function
Marker Zoom	Substitutes the sweep parameter value at the main marker on the current active trace (A or B) into the sweep center value and simultaneously changes the current sweep span value to the sweep span value specified with the Zooming Aperture . In other words, the sweep range is changed so that the marker position is the new sweep center value and the sweep span is magnified by the amount specified with the Zooming Aperture .
Zooming Aperture	Sets the zooming aperture (ratio of the new sweep span value to the current sweep span value) used when the Marker Zoom is executed as a percentage. The current active marker position is set as the new sweep center value, and the new sweep span value is set depending on the specified zooming aperture. As a result, the trace will be magnified (zoomed in) by focusing on the main marker position.

NOTE

For the ratio of the new sweep span value to the current sweep span value (%), you can set a value between 0.01% and 100% in steps of 0.01%. The default value of power-on and preset state is 10%.

Using Time as Sweep Parameter (Zero Span Sweep)

Setting the sweep span to zero allows you to perform a measurement with time as a sweep parameter. This kind of sweep is also called zero span sweep. The following procedure allows you to time sweep and the measurement parameter is displayed versus time.

1. Press **Span** > **0** > **x1** to set the span value to 0 (zero span).
2. Press **Center**, then input the desired value (frequency, power, or DC bias).
3. Press **Sweep Setup** > **Sweep Time**, then input the duration of the sweep which is displayed on X-axis.
4. Press **Marker** to display the marker 1. The time at the marker shows as the marker position value at the upper left corner on the screen.

Setting Number of Points (NOP)

1. Press **Sweep Setup** to display the Sweep Setup menu.
2. Press **Points** and input the desired number of points.

NOTE

The number of sweep points can be set to any integer from 2 to 1601. When list is selected as a sweep type (list sweep), use a list sweep table to set the number of points. Setting the number of points is commonly applied to traces 1 and 2.

Selecting Sweep Direction

1. Press **Sweep Setup** to display the Sweep Setup menu.
2. Press **Directions** and select either **Up** or **Down** sweep direction.

NOTE

The sweep direction enables you to select the direction of the sweep. By default, the direction is **Up**. **Down** direction refers to sweep of opposite direction (from right to left).

Setting Time Delay for Measurement

Time delay can be set for the period before sweep or actual measurement starts after the measurement signal is applied to the DUT. This function is useful, for example, when a certain period is required before the characteristics of the DUT become stable after the signal is applied, such as crystal resonators. Another application of this function is to observe changes in the impedance of the DUT in the time domain for a long span.

Setting with Time Delay at Measurement Point

The time delay for each measurement points can be set by either or both of following two methods. The time delay is defined as follows. The sweep time in softkey is not the total sweep time.

$$\text{Point Wait Time} = \text{Point Delay} + (\text{Sweep Time} / \text{Number of points})$$

NOTE

Maximum point delay time is 30 seconds.

NOTE

Total wait time for each point is maximum 67 seconds. If it is exceeded, an [error](#) occurs.

NOTE

Waiting time is applied each time when iteration is caused due to impedance ranging or when using auto level control (ALC).

This function is useful to reduce the effect of stimulus condition changing when measuring the slow response devices. (It's useful even in the measurement with span 0.)

Setting with Point Delay

1. Press **Sweep Setup** > **Point Delay** and input the desired time delay at a point.

Setting with Sweep Time

1. Press **Sweep Setup** > **Sweep Time** and input the desired time.

Timing Chart for Sweep

When the trigger mode is set at "On Sweep"

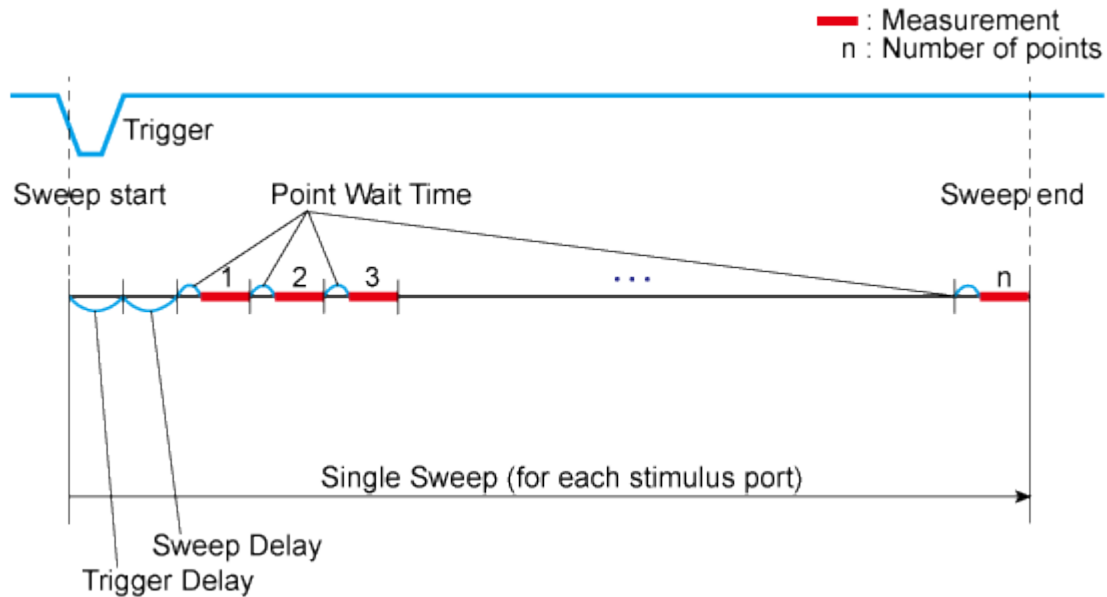

e4990a104

When the trigger mode is set at "On Point".

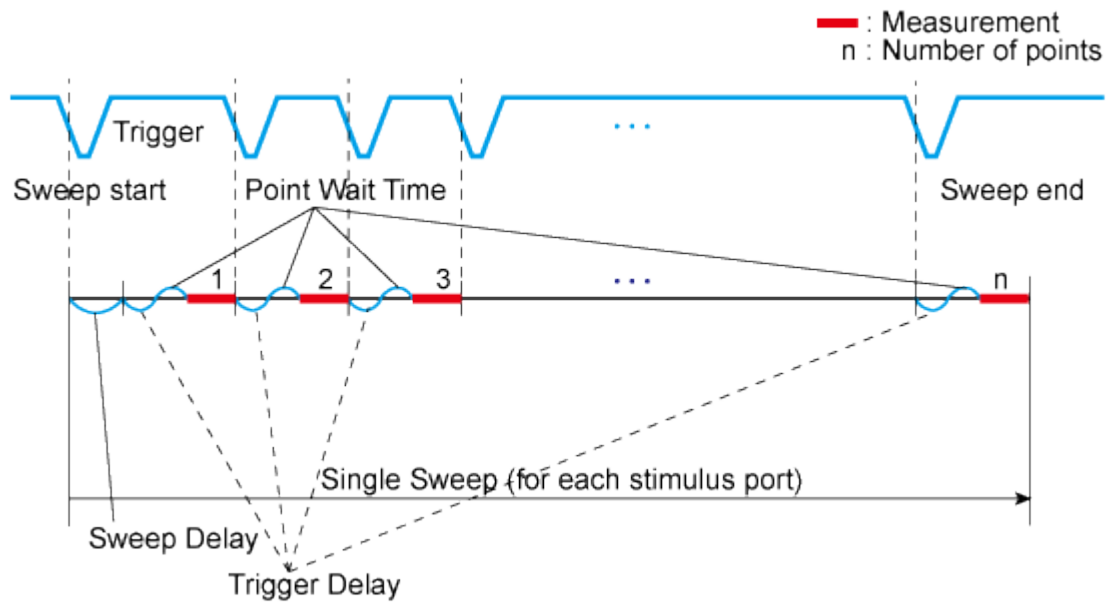

e4990a105

NOTE

Trigger delay is available only when trigger source is set at external.

[Setting with Sweep Delay](#)

Time delay can be set at the point before sweep starts. This is useful when extra waiting time is required to control the effect to the DUTs when starting the new sweep. (It is common that the stimulus condition like frequency or OSC level changes a lot when the instrument finishes the previous sweep and returns to the first point of sweep.)

1. Press **Sweep Setup** to display the Sweep Setup menu.
2. Press **Sweep Delay** and input the desired sweep time delay.

NOTE Maximum sweep delay time is 30 seconds.

NOTE Total wait time for each point is maximum 67 seconds. If it is exceeded, an [error](#) occurs.

Setting with Band Change Delay

Time delay can be set when the E4990A needs to change its internal circuit or reset null-loop. This is useful when extra waiting time is required to stabilize the measurement fluctuation due to DUT time constant characteristic.

1. Press **System** > **Meas Setup** > **Band Delay**.
2. Input the desired band change delay.

Setting Measurement Time

1. Press **Avg** to display the Averaging menu.
2. Press **Meas Time** and select the desired measurement speed time. The available options are **1|2|3|4|5** with **1** being the fastest time (maximized speed) and **5** being the most precise (accuracy maximized).

NOTE Setting a greater measurement time will improve measurement accuracy, but keep in mind that this requires a longer measurement time.

Averaging Between Sweeps (Sweep-to-Sweep Averaging)

Sweep-to-sweep averaging computes each data point (vector value) based on an exponential average of consecutive sweeps weighted by a user-specified averaging factor. The sweep-to-sweep uses the algorithm shown below:

$$\text{Sweep-To-Sweep Averaging Algorithm } A_n = \frac{S_n}{F} + \left(1 - \frac{1}{F}\right) \times A_{n-1}$$

where:

A_n = Sweep-to-sweep averaging result (vector value) at the measurement point when the sweep count is "n."

S_n = Current measurement value (vector value) at the measurement point when the sweep count is "n."

F = Sweep-to-sweep averaging factor (entered with the **AVERAGING FACTOR** key)

Perform the averaging factor setup as follows:

1. Press **Avg** to display the Averaging menu.
2. Press **Avg Factor** and input the desired averaging factor value.

NOTE The sweep-to-sweep averaging can be set to any natural number from 1 to 999. Setting the sweep-to-sweep averaging to 1 is equivalent to turning the averaging OFF (**Averaging > OFF**).

3. Press **Averaging** and toggle between the **ON|OFF** selection to turn ON/OFF the sweep-to-sweep averaging factor.

NOTE When the sweep-to-sweep averaging is turned ON, the value of sweep-to-sweep averaging that has been performed for the trace is shown on the instrument status bar. The sweep-to-sweep averaging starts once its turned ON (**Averaging > ON**) or after pressing the **Averaging Restart** key. When the averaging starts, "0" is displayed for the averaging count because the number of traces (sweep data) to be swept is always set to 0 at the initial state. Then the count increases by 1 as each sweeping ends. After the count reaches the number specified by the **Avg Factor** key, it stays constant while sweeping continues.

Making Sweep Averaging Measurement with Single Trigger

The averaging trigger function is used to execute the sweep the number of times specified by the averaging factor with a single trigger when the sweep averaging function is **ON**.

Averaging Trigger	Function
ON	Performs the sweep the number of times specified by the averaging factor with a single trigger.

OFF	Performs the sweep once with a single trigger.
------------	--

The averaging factor is cleared before the start of measurement.

NOTE

When the point trigger function is ON, its setting has priority, and you need to generate triggers based on "(number of measurement points) × (averaging factor)". When the sweep averaging function is OFF, sweep is performed only once even if the averaging trigger function is set to ON.

Setting Averaging Trigger Function

When the sweep averaging function is **ON**, follow these steps to set the averaging trigger function.

1. Press **Avg** to display the Averaging menu.
2. Press **Avg Trigger** and select **ON** to activate the averaging trigger.

Executing Averaging Measurement

1. Press **Trigger**.
2. Press **Single**. The averaging factor is cleared before the start of measurement, the sweep is executed the number of times specified by the averaging factor, and then the instrument waits for the next trigger.

Averaging for Each Measurement Point (Point Averaging)

Point averaging averages each data point by a user-specified averaging factor. The Keysight E4990A repeatedly measures the same point until the averaging factor is reached. It then divides the vector summation of the measurement value by the averaging factor and starts measuring the next point. The sweep time increases in proportion to the averaging factor.

The algorithm used for point averaging is shown below:

Point Averaging Algorithm

$$M = \frac{1}{F} \sum_{n=1}^r S_n$$

where:

M = Point averaging result (vector value) at the measurement point

S_n = Current measurement value (vector value)

F = Point averaging factor (entered with **POINT AVG FACTOR** key)

Perform the averaging factor setup as follows:

1. Press **Avg** to display the Averaging menu.

2. Press **Point Avg Factor** and input the desired point averaging factor value.

NOTE The value of point averaging can be set to any natural number from 1 to 999. Setting the point averaging to 1 is equivalent to turning the averaging OFF.

3. Press **Point Avg** and toggle between the **ON|OFF** selection to turn ON/OFF the point averaging factor.

Setting Source

- [Setting Fixed Frequency at OSC/DC Bias Sweep](#)
- [Selecting Unit for Oscillator Level \(Voltage or Current\)](#)
- [Setting Oscillator Level](#)
- [Controlling Oscillator Level \(ALC\)](#)
- [Setting and Applying dc Bias](#)

[Other topics about Setting Measurement Conditions](#)

Setting Fixed Frequency at OSC/DC Bias Sweep

Follow the steps below to specify a fixed frequency for the signal source when the sweep parameter is any item other than frequency (i.e., oscillator level or dc bias).

1. Press **Sweep Setup**.
2. Press **CW Freq** and input the desired fixed frequency value.

Selecting Unit for Oscillator Level (Voltage or Current)

1. Press **Sweep Setup** > **OSC Level** to display the oscillator level settings menu.
2. Press **OSC Unit** and select your desired oscillator level by toggling between the **Voltage|Current** option.
 - a. The unit specified for oscillator level through the steps above will be applied to the unit for oscillator level sweep (voltage level sweep or current level sweep) and the unit for the fixed oscillator level when sweeping parameters other than oscillator level. The setting for the unit will not affect the setting for the signal source level monitoring function, since the function displays both voltage and current levels.
 - b. Settings of the unit for oscillator level are commonly applied to both traces. Hence, you do not need to select and verify an active trace before setting.

Setting Oscillator Level

1. Press **Sweep Setup** > **OSC Level** to display the oscillator level settings menu.
2. The **Voltage Level** or **Current Level** is enabled depending on your [oscillator selection](#). For example, if you have selected **OSC Unit** > **Voltage**, then **Voltage Level** is enabled. then, press the **Voltage Level** and input the desired voltage level value.

Controlling Oscillator Level (ALC)

1. Press **Sweep Setup** > **OSC Level** > **ALC** to display the ALC level settings menu.
2. Press **ALC** > **ON|OFF** to toggle between On or Off the ALC level.
3. Press **Max Iteration** and input the desired maximum iteration value, between **2** and **10**.
4. Press **Target %** and input the desired value, between **0.05** to **10**.

Setting and Applying dc Bias

Follow the steps below to apply dc bias to DUT, regardless of whether you plan to sweep by dc bias.

Selecting dc bias mode

1. Press **Sweep Setup** > **DC Bias** > **DC Bias Mode** to display the DC bias mode selection options.
2. Select one of the DC bias mode, either **Voltage** or **Current**.

Selecting constant mode

1. Press **Sweep Setup**.
2. Press **DC Bias** > **Constant Mode** and toggle between the **ON|OFF** selection to turn ON/OFF the constant mode.

Setting fixed dc bias level

When the sweep parameter is not dc bias, [select the dc bias mode](#) and then follow the steps below to set dc bias level.

1. Press **Sweep Setup** > **DC Bias** to display the DC bias selection options.
2. The **Voltage Level** or **Current Level** is enabled depending on your [dc bias mode selection](#). For example, if you have selected **DC Bias** > **DC Bias Mode** > **Voltage**, then **Voltage Level** is enabled. then, press the **Voltage Level** and input the desired voltage level value.

Setting limits for dc voltage

When constant voltage or current is selected for the dc bias mode, follow the steps below to set limit values for the voltage (upper and lower limits) in order to protect the DUT being measured.

To set the maximum limit voltage:

1. Press **Sweep Setup**.

2. Press **DC Bias** > **Max Limit Voltage** and input the maximum limit value.

To set the minimum limit voltage:

1. Press **Sweep Setup**.
2. Press **DC Bias** > **Min Limit Voltage** and input the minimum limit value.

NOTE The dc voltage limit values specified by the **Max Limit Voltage** or **Min Limit Voltage** key take effect when the dc bias mode is constant voltage or current. The setting for these values is disabled when the dc bias mode is set to non-constant.

Setting dc bias range to 1 mA

Set the dc bias range before turning the dc bias ON. The dc bias range is set to optimize the dc current given to the impedance measurement circuit. This setting affects the accuracy of the impedance measurement regardless of which dc bias mode is selected or whether dc bias is turned ON or OFF. Normally, maximum accuracy can be obtained by setting the dc bias range as narrow as possible. An initial dc bias range of 1 mA is recommended for the first measurement when dc bias is applied.

NOTE When you do not apply dc bias, always set the dc bias range to 1 mA, which is the preset setting. Keeping this setting is especially important when you run through the sequence of applying dc bias, turning off dc bias, and then performing a measurement.

1. Press **Sweep Setup**.
2. Press **DC Bias** > **Meas Range** and set the dc bias range to 1 mA.

NOTE Always set the dc bias range to 1 mA when you measure without applying dc bias.

Turning dc bias ON or OFF

1. Press **Sweep Setup**.
2. Press **DC Bias** > **DC Bias State** and toggle between the **ON|OFF** selection to turn ON/OFF the dc bias state.

NOTE Turning dc bias ON displays **DC ON** at the instrument bar in the lower right area of the screen.

NOTE

Optimizing dc bias range

1. Press **Sweep Setup**.
2. Press **DC Bias** > **Meas Range** and select the desired the dc bias range to within **1mA|10mA|100mA** selection options.

DC bias delay

1. Press **Sweep Setup**.
2. Press **DC Bias > DC Bias Delay** and input the delay time value.

Setting Trigger

- [Overview](#)
- [Selecting a Method to Start Measurement \(Trigger Source\)](#)
- [Selecting Sweep Trigger/Measurement Point Trigger](#)
- [Setting the External Trigger](#)
- [Controlling Trigger](#)
- [Sweeping Multiple Sweep Ranges with Different Conditions in a Single Action \(Segment Sweep\)](#)

[Other topics about Setting Measurement Conditions](#)

Overview

The E4990A has one trigger source. When this trigger source detects a trigger signal that has occurred, a sweep or point measurement is performed for channels.

The execution of measurement for each channel does not depend on whether the channel is displayed. Channels that have been activated can be measured even if they are not displayed.

For each channel, a sweep is performed only for the stimulus ports required to update the parameters of the displayed trace.

Selecting a Method to Start Measurement (Trigger Source)

The trigger source generates a cue signal that initiates a measurement process. Four types of trigger sources are available:

1. Press **Trigger > Trigger Source**, then select the desired trigger source.

Trigger Sources	Function
Internal (Internal)	Uses a consecutive signal generated by the firmware as a trigger source. Triggers are sent immediately following the completion of each measurement.
External (External)	Uses the external trigger input terminal (BNC) or 24 Bit I/O (Pin No. 18) as a trigger source.

Manual (Manual)	A trigger is generated by pressing Trigger > Trigger . Press Trigger > Restart to regenerate trigger.
Bus (Bus)	A trigger is generated through GPIB/LAN/USB.

Selecting Sweep Trigger/Measurement Point Trigger

The point trigger provides a point measurement at every trigger, and it can be used to change the trigger event to point trigger mode.

1. Press **Trigger** > **Trigger Event**, then select the desired trigger event.

Softkey Label	Function
On Point	Measures at each measurement point.
On Sweep	Measures all measurement points.

NOTE

When the trigger source is the internal trigger, the point trigger does not work

See [Setting with Time Delay at Measurement Point](#) for time chart.

Setting the External Trigger

Selecting Polarity

1. When **External** is selected as a trigger source, click **Ext Trig Input** to select trigger polarity.

Softkey Label	Function
Negative Edge	Detect external trigger with negative edge.
Positive Edge	Detect external trigger with positive edge.

NOTE

The setting for trigger polarity is NOT valid for the [external trigger](#) from the 24 Bit I/O (Handler).

Setting with Trigger Delay

Set the external trigger delay time at each point. The trigger delay works when the [trigger source](#) is set to external.

1. Press **Trigger** > **Trig Delay**.
2. Enter an external trigger delay time.

See the [timing chart for sweep](#).

Trigger Delay Time and Point Trigger Interval

External trigger pulses which are supplied until the next measurement becomes ready after the start of a one-point measurement, are ignored, and the next trigger is generated by a pulse supplied after the completion of the one-point measurement.

The time until the next trigger can be accepted after the start of a one-point measurement depends on the IFBW and other settings of the analyzer. For example, in the case of a frequency's zero-span measurement, the time until the next measurement is ready after the start of a one-point measurement is obtained by dividing the time required for a single sweep in On Sweep mode, instead of On Point mode, by the number of measurement points. If you use the point trigger function with external trigger pulses that are wider than this time, point trigger measurement is performed at each pulse input.

The figure below shows the timing chart of an external trigger when the point trigger function is on.

Timing chart of external trigger (trigger source = external)

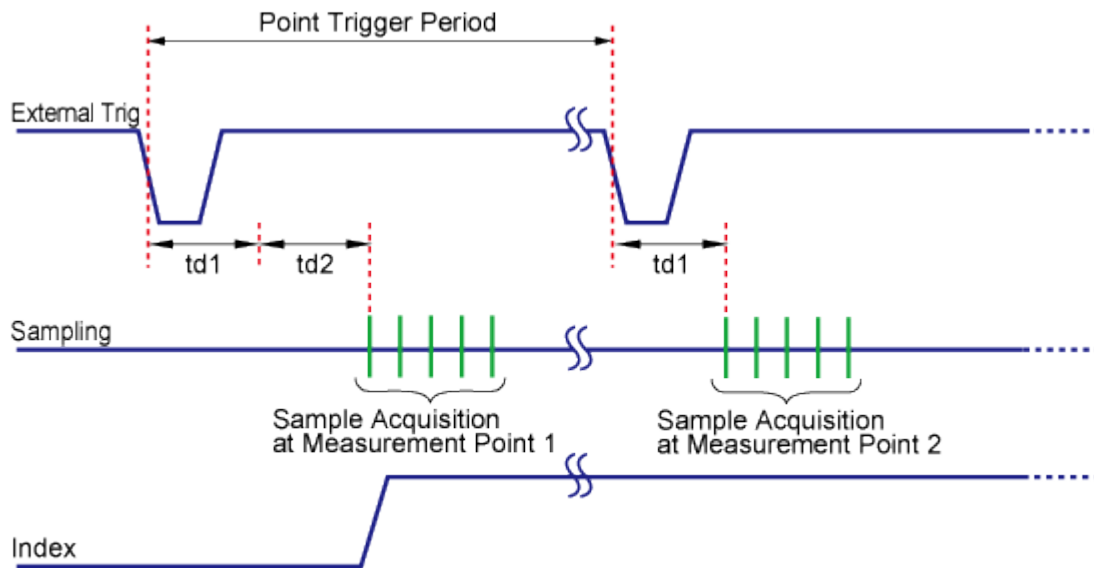

e5061b036

The table below describes signals and time as shown in the above figure.

Signal,	Description
---------	-------------

time	
External Trig	External trigger signal to be supplied.
Sampling	Time while the E4990A is actually performing measurement.
Index	Index signal of the handler I/O port. When the point trigger function is ON, it goes to the High level only before starting the measurement of the first sweep point and returns to the Low level after completing the measurement of all the measurement points.
Point Trigger Period	Time until the E4990A is ready to accept a trigger for the next measurement point. The value depends on the measurement conditions and the settings of the E4990A.
td1	Time set as the external trigger delay time.
td2	Time for sweep delay .

Controlling Trigger

Setting Trigger Mode (Single/Continuous)

You can set the trigger mode for each channel independently. This allows you to control the operation of each channel after a trigger signal is detected by setting the channel's status with the trigger mode.

1. Press **Channel Next** (or **Channel Prev**) to select the channel for which the trigger mode will be set.
2. Press **Trigger**, then select the desired trigger mode.

Softkey	Function
Hold	Sets active channel trigger mode to hold.
Single	Sets active channel trigger mode to single sweep.

Continuous	Sets active channel trigger mode to continuous sweep.
Hold All Channels	Sets all channel trigger modes to hold.
Continuous Disp Channels	Sets trigger modes of all displayed channels (Display > Allocate Channels) to continuous sweep.

3. Repeat the procedure until each channel is set to its trigger mode.

Making Trigger to Active Channel Only (Trigger Scope)

The trigger scope specifies the scope of the triggering, whether it is for all channels or for the active channel.

For example, when **Trigger** > **Continuous** is selected for all the channels and the trigger scope is set to active channel, a measurement channel is automatically changed by changing an active channel.

1. Press **Trigger** > **Trigger Scope**, then select the desired trigger scope.

Softkey Label	Function
All Channel	Sets active channel trigger mode to hold.
Active Channel	Triggers Active channel alone.

Sweep with unlimited times (continuous sweep)

1. Press **Trigger** > **Continuous** to select continuous sweep.

NOTE When continuous sweep is selected, sweeping can be repeated unlimited times after it is triggered. Press the **Hold** key to stop the sweeping. No further sweeping can be triggered after it is stopped.

Stopping sweep

1. Press **Trigger** > **Hold** to stop the sweep.

NOTE Pressing the **Hold** key immediately stops sweeping, regardless of which sweeping state (single, specified times, or

continuous) is selected. No further sweeping can be triggered after it is stopped.

Sweeping Multiple Sweep Ranges with Different Conditions in a Single Action (Segment Sweep)

Concept of Segment Sweep

To perform a segment sweep, you must define two or more frequency ranges, called segments, and then specify the number of points, OSC level, Bias Level, measurement time, sweep delay time, and sweep time for each segment. All segments are swept sequentially as if swept in one sweep operation.

NOTE By skipping the frequency range, which does not need to be measured, you can sweep and measure only the portions you need.

NOTE You can define the optimum measurement conditions for each of the segments you designate. For example, you can specify as many points as possible in a segment requiring high trace resolution and as few points as possible in a segment not requiring high resolution. This shortens the measurement time, enabling you to optimize the overall measurement throughput by not having to perform the entire operation under the same measurement conditions of a particular frequency range.

Preparing Segment Sweep Table

Set the segment sweep with the segment sweep table.

1. Press **Sweep Setup** display the sweep setup menu.
2. Press **Edit Segment Table**. The segment table appears in the lower section of the screen.
3. Select the softkey below to change the frequency range setting mode for each segment.

Softkey Label	Function
Freq Mode	Switches the frequency range setting mode (Start/Stop or Center/Span)
List OSC Level	Toggles ON/OFF the OSC level setting for each segment; the column for OSC Mode and OSC Level only appears in the segment table when this is turned ON

List Bias	Toggles ON/OFF the bias setting for each segment; the column for Bias Mode and Bias Level only appears in the segment table when this is turned ON
List Meas Time	Toggles ON/OFF the measurement time setting for each segment; the column for Meas Time only appears in the segment table when this is turned ON
List Average	Toggles ON/OFF the averaging value setting for each segment; the column for Point Avg only appears in the segment table when this is turned ON
List Segment Time	Toggles ON/OFF the segment sweep time setting for each segment; the column for Segment Time setting only appears in the segment table when this is ON
List Segment Delay	<p>Toggles ON/OFF the sweep delay time setting for each segment; the column for Segment Delay setting only appears in the segment table when this is ON</p> <p>NOTE Maximum delay time is 30 seconds for each segment.</p> <p>NOTE Total wait time for each point is maximum 67 seconds. If it is exceeded, an error occurs.</p>

Selecting the Segment Sweep as the Sweep Type

To execute a segment sweep by using the segment table you have created, you must specify the sweep type for that sweep operation by following the steps below.

1. Press **Sweep Setup** display the sweep setup menu.
2. Press **Sweep Type > Segment**.

Setting the Horizontal Axis of the Graph (Frequency/Order Base Display)

Define the method of displaying traces when the segment sweep is executed by following the steps described below.

1. Press **Sweep Setup** display the sweep setup menu.
2. Press **Segment Display > Freq Base|Order Base**.

Calibration

Calibration

This chapter describes calibration methods for the E4990A Impedance Analyzer.

- [Selecting Appropriate Calibration Method](#)
- [A. Direct Connection Type Test Fixture](#)
- [B. Calibration for Four-Terminal Pair, 1-m Extension](#)
- [C. Calibration for Four-Terminal Pair, 2-m Extension](#)
- [D. Exclusive Fixture](#)
- [E. 42942A, 7-mm Port Extension](#)
- [F. 42941A, Probe Adapter](#)
- [G. 42941A, 3.5-mm Port Extension](#)
- [User Calibration](#)
- [Port Extension Compensation](#)
- [Fixture Compensation](#)
- [Selecting Calibration/Compensation Data Points](#)

Selecting Appropriate Calibration Method

The E4990A has three calibration types: user calibration, port extension compensation, and fixture compensation. Table below shows each device connection and its corresponding adapter selection and calibration. Calibration should be done according to the particular requirements of each device connection.

Device Connection	Adapter Selection	Accessory	Calibration (√ : required, - : not required)		
			User Calibration	Port Extension Compensation	Fixture Compensation

E4990A Impedance Analyzer Help

<p>A. Connect a direct connection type test fixture to the four-terminal pair port of the E4990A and connect the device to the fixture.</p>	<p>No adapter (NONE)</p>	<p>16034E 16034H 16044A 16047A 16047D 16047E 16065A¹ 16089A¹ 16089B¹ 16089C¹ 16089D¹ 16089E¹</p>			<p>Open</p>
		<p>16034G</p>			<p>Open Load connection requires the more than 1 MHz.</p>
<p>B. Extend the four-terminal pair port of the E4990A with a 1-meter-long four-terminal pair configuration and connect the device.</p>	<p>Four-terminal pair, 1 meter (4TP 1M)</p>	<p>16048G and test fixture</p>			<p>Series fixture direct connection four-terminal pair</p>
		<p>16048G and 16452A</p>			<p>Shunt</p>
		<p>16334A, 16451B</p>			<p>Open</p>
<p>C. Extend the four-terminal pair</p>	<p>Four-terminal pair, 2</p>	<p>16048H and test fixture</p>			<p>Series fixture direct</p>

Measurement

<p>port of the E4990A with a 2-meter-long four-terminal pair configuration and connect the device.</p>	<p>meters (4TP 2M)</p>	<p>16048H and 16452A</p>			<p>con four pair</p> <p>Sho</p>
<p>D. Connect the 42942A directly to the four-terminal pair port of the E4990A, connect a dedicated test fixture to the 7-mm port, and then connect the device to the fixture contacts.</p>	<p>42942A Terminal Adapter (7mm 42942A)</p>	<p>42942A and 16092A 42942A and 16192A</p>	<p>√ (perform when user-defined calibration kit is used)</p>		<p>Ope</p>
		<p>42942A and 16454A</p>			<p>Sho</p>
<p>E. Connect the 42942A directly to the four-terminal pair port of the E4990A, connect a coaxial cable to the 7-mm port, connect a test fixture, and then connect the device to the fixture</p>	<p>42942A Terminal Adapter (42942A Extension)</p>	<p>42942A, coaxial cable, and test fixture</p>	<p>√ (use Keysight's calibration kit or user-defined calibration kit)</p>	<p>√</p>	<p>Sar fixt dire con terr ada</p>

E4990A Impedance Analyzer Help

contacts.					
F. Connect the 42941A directly to the four-terminal pair port of the E4990A, connect a dedicated probe adapter to the 3.5-mm port, and then connect the device to the adapter contacts.	42941A Impedance Probe (PROBE 42941A)	42941A and dedicated probe adapter	√ (perform when user-defined calibration kit is used)		Open
G. Connect the 42941A directly to the four-terminal pair port of the E4990A, connect a coaxial cable to the 3.5-mm port, connect a test fixture, and then connect the device to the fixture contacts	42941A Impedance Probe (42941A Extension)	42941A and coaxial cable and test fixture	√ (use Keysight's calibration kit or user-defined calibration kit)	√	Record different test and

¹ Although it has a cable, it falls into the category of direct connection type test fixture for adapter setup.

NOTE

The user calibration data and fixture compensation data can be saved in the mass storage of the E4990A.

[Other topics about Calibration](#)

A. Direct Connection Type Test Fixture

This section describes the calibration procedures to follow when a direct connection type test fixture is connected to the four-terminal pair port of the E4990A and a device is connected to the test fixture contacts.

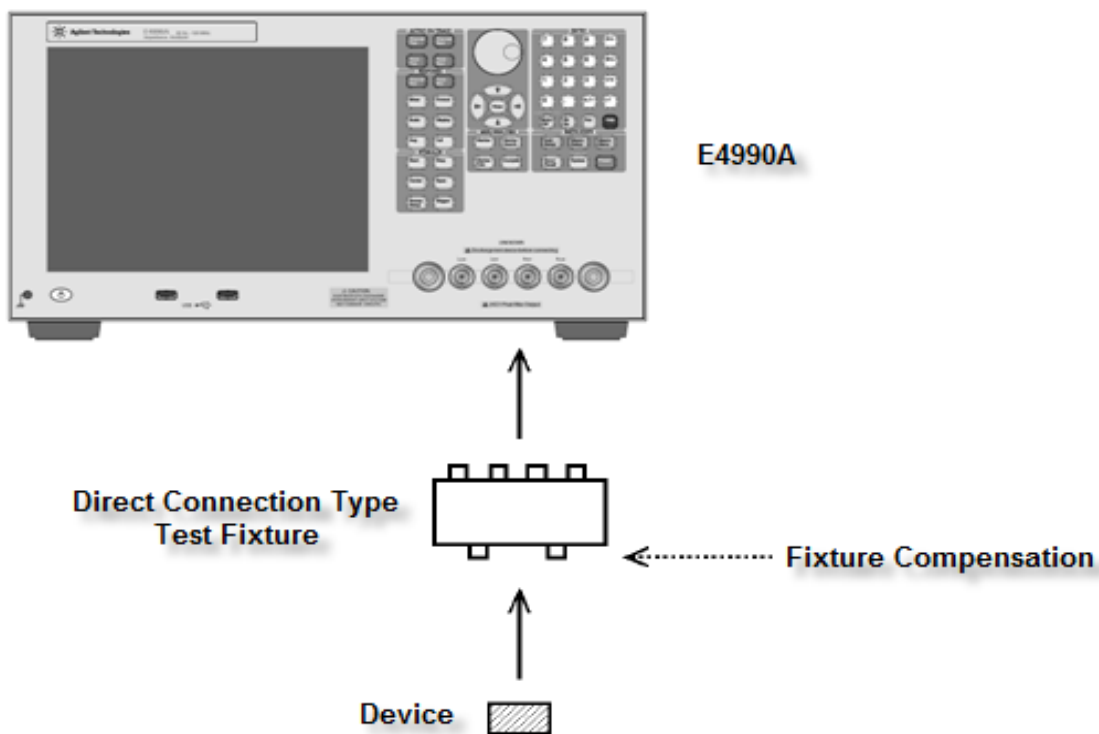

e4990a013

Direct connection type test fixtures include:

- 16034E Chip component test fixture
- 16034G Chip component test fixture
- 16034H Chip component test fixture
- 16044A Chip component test fixture
- 16047A Lead component test fixture
- 16047D Lead component test fixture
- 16047E Lead component test fixture

E4990A Impedance Analyzer Help

Although the following test fixtures have cables, their calibration must be performed in the same way as a direct connection type test fixture:

- 16065A External DC Bias Fixture
- 16089A Kelvin Clip Lead
- 16089B Kelvin Clip Lead
- 16089C Kelvin Clip Lead
- 16089D Alligator Clip Lead
- 16089E Kelvin Clip Lead

Perform the fixture compensation in accordance with [Fixture Compensation](#).

NOTE

When you use a direct connection type test fixture, neither user calibration nor port extension compensation is required for measurement (they cannot be performed).

[Other topics about Calibration](#)

B. Calibration for Four-Terminal Pair, 1-m Extension

This section describes the calibration procedures to follow when the four-terminal pair port of the E4990A is extended with a 1-meter-long four-terminal pair configuration and the device is connected to the cable's end with a minimal connection.

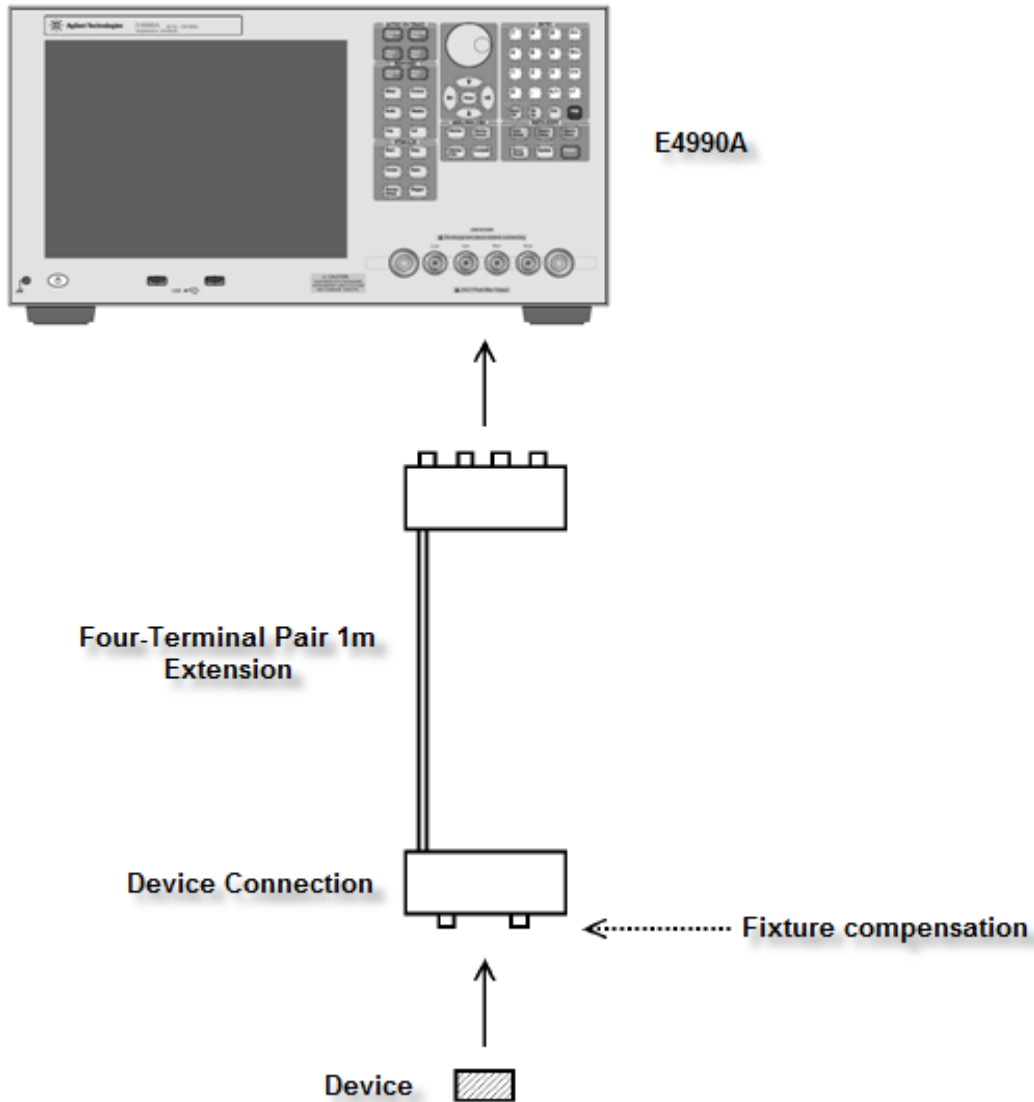

e4990a014

This calibration procedure is applied to the following connections:

- The 16048G (1-m Cable) is connected to the E4990A and device is connected to the cable's end with a test fixture.
 - The 16048G (1-m Cable) is connected to the E4990A and 16452A (Liquid Test Fixture) is connected to the end of the cable.
 - The 16334A (Tweezer Type Test Fixture) is connected to the E4990A.
 - The 16451B (Dielectric Test Fixture) is connected to the E4990A.
1. Make sure that the [adapter selection](#) is set to **4TP 1M**. Perform [Adapter Setup](#) if it is not done yet.
 2. Perform the fixture compensation in accordance with [Fixture Compensation](#).

NOTE When the measurement port is extended by 1 meter with the four-terminal pair configuration, neither user calibration nor port extension compensation is required for measurement (they cannot be performed).

Fixture Compensation When the 16451B/16334A is Used

When you perform only the fixture OPEN compensation and fixture SHORT compensation, follow the normal fixture compensation procedures described in [Fixture Compensation](#).

If you perform the LOAD compensation in addition to the OPEN and SHORT compensations, set the standard values as described below in accordance with the procedures in [Defining the Standard Values for Fixture Compensation](#).

For the 16334A over 3 MHz measurement, the load compensation is recommended according to the following procedure. The proportional error factor in the additional error caused by the fixture is in proportion to the frequency squared. Therefore, the error increases greatly as the frequency goes high.

1. Set the 100 Ω SMD resistor on the direct connection type fixture (like 16034G), and perform measurement at 3 MHz to determine the value of the 100 Ω SMD resistor.
2. Set the measured [resistance and inductance values](#) to the instrument as load value.
3. Perform load compensation of the 16334A.

For 16451B, see the table of load value in 2.4.5 Operation Method of <http://literature.cdn.keysight.com/litweb/pdf/5980-2862EN.pdf>.

[Other topics about Calibration](#)

C. Calibration for Four-Terminal Pair, 2-m Extension

This section describes the calibration procedures to follow when the four-terminal pair port of the E4990A is extended with a 2-meter-long four-terminal pair configuration and the device is connected to the cable's end with a minimal connection.

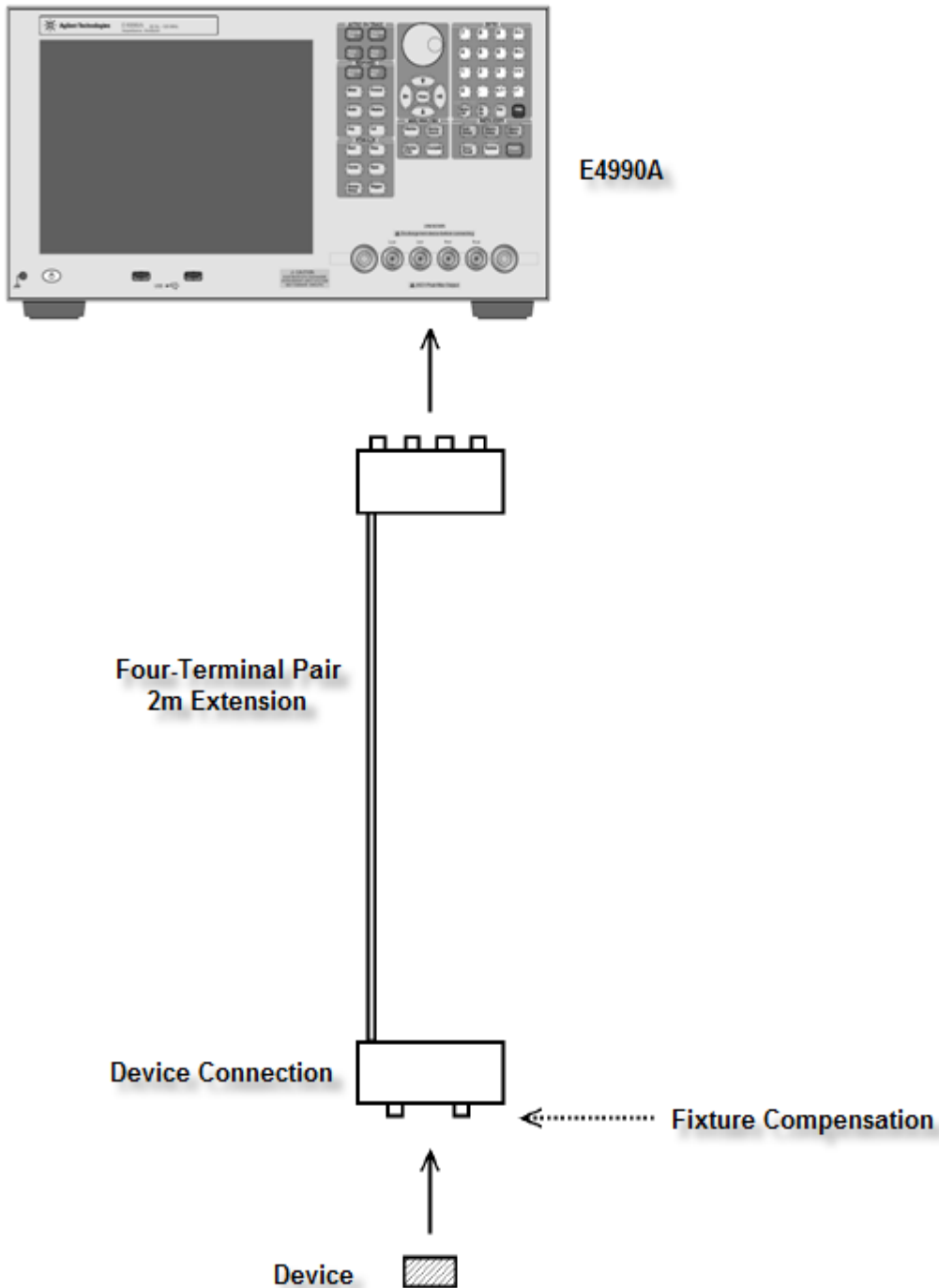

e4990a015

This calibration procedure is applied to the following connections:

- The 16048H (2-m Cable) is connected to the E4990A and the device is connected to the cable's end with a test fixture.
- The 16048H (2-m Cable) is connected to the E4990A and 16452A (Liquid Test Fixture) is connected to the end of the cable.

1. Make sure that the [adapter selection](#) is set to **4TP 2m**. Perform [Adapter Setup](#) if it is not done yet.
2. Perform the fixture compensation in accordance with [Fixture Compensation](#).

NOTE When the measurement port is extended by 2 meter with the four-terminal pair configuration, neither user calibration nor port extension compensation is required for measurement (they cannot be performed).

[Other topics about Calibration](#)

D. Exclusive Fixture

When an exclusive test fixture is connected to the 7-mm port of the 42942A Terminal Adapter, which is connected to the four-terminal pair port of the E4990A, and a device is connected to the test fixture, perform the calibration procedure described below.

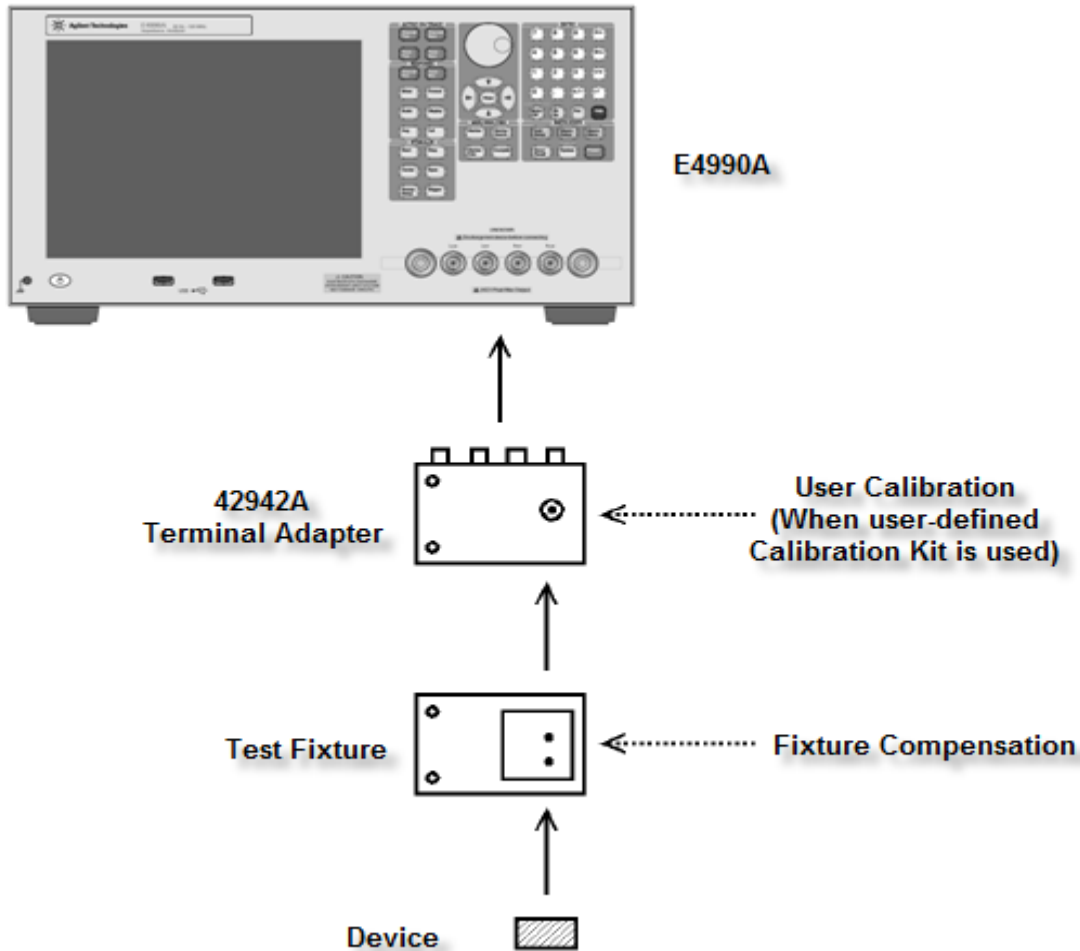

e4990a016

This calibration procedure is applied when the following test fixtures are connected to the 42942A's 7-mm port:

- 16092A Lead/Chip component test fixture
 - 16192A Chip component test fixture
 - 16454A Magnetic material test fixture
1. Make sure that the [adapter selection](#) is set to **7mm 42942A**. Perform [Adapter Setup](#) if it is not done yet.
 2. When performing calibration for the 7-mm port of the E4990A with a user-defined calibration kit, be sure to use the proper calibration kit. Refer to [User Calibration](#). User calibration is not required if you do not use a user-defined calibration kit.
 3. Connect a test fixture to the 7-mm port of the 42942A Terminal Adapter. See the operation manual of each test fixture for the appropriate connection setup.

4. Perform the fixture compensation at the device contacts (electrodes) of the fixture. See [Fixture Compensation](#) for the fixture compensation procedure.

NOTE When an exclusive test fixture is connected to the 7-mm port of the 42942A which is also connected to the four-terminal pair port of the E4990A, port extension compensation is not required.

[Other topics about Calibration](#)

E. 42942A, 7-mm Port Extension

Perform the following calibration when the 7-mm port of a 42942A connected to the E4990A is extended with a one-port configuration and the device is connected to the cable's end with a minimal connection.

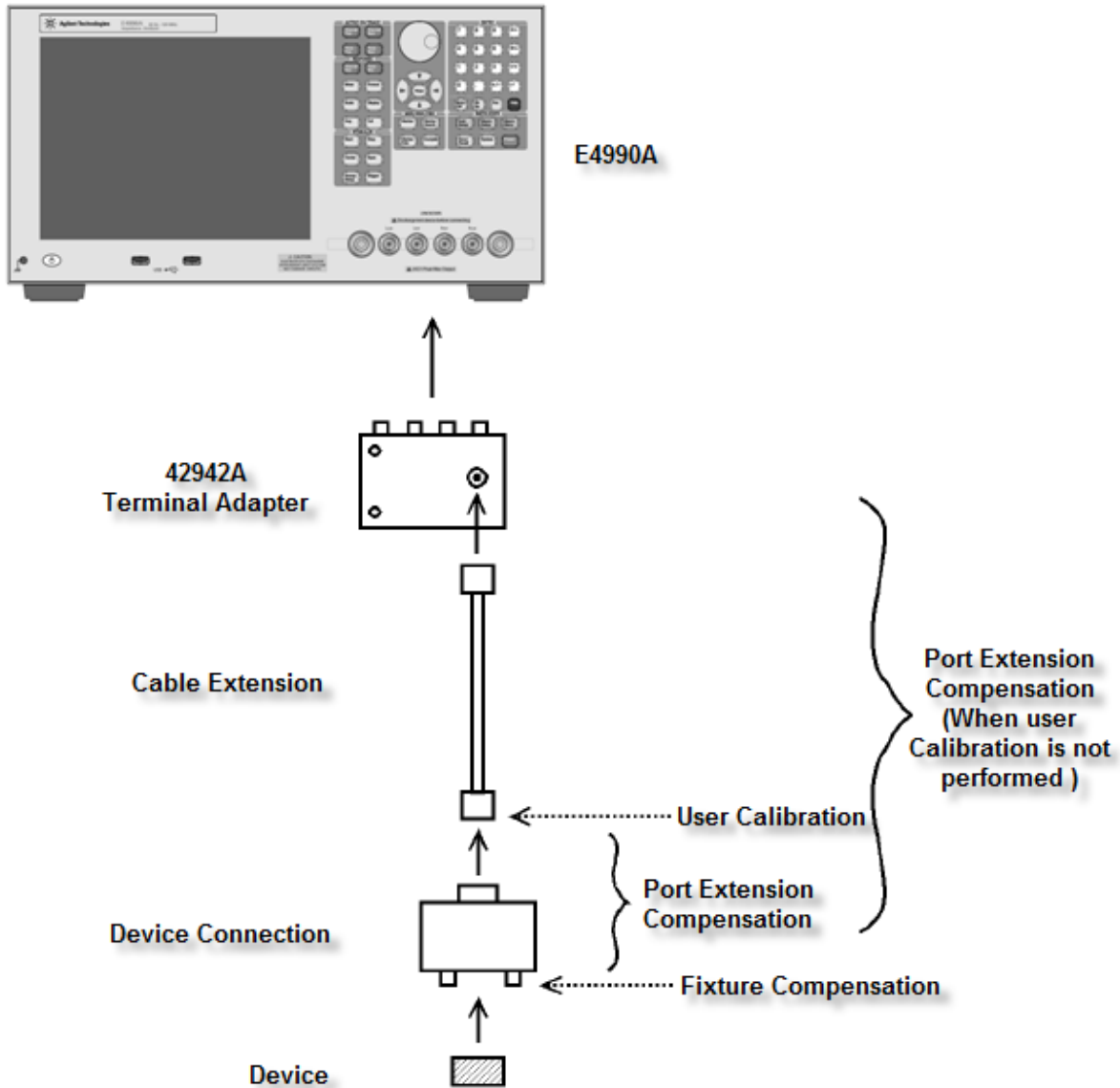

e4990a017

1. Make sure that the [adapter selection](#) is set to **42942A Extension**. Perform [Adapter Setup](#) if it is not done yet.
2. Perform the user calibration at the other end of the extended 7-mm port of the 42942A Terminal Adapter. You can use either the calibration kit supplied or a user-defined calibration kit. See [User Calibration](#) for the user calibration procedure.
3. Set the port extension value in electrical length or delay time, which is equivalent to the electrical length between the user calibration plane and the device contacts of the test fixture, in accordance with [Port Extension Compensation](#).

NOTE

In measurements using the E4990A, the electrical length (delay time) of a 42942A dedicated test fixture (such as

16092A) and 42941A's dedicated probe adapter can be regarded as 0.

4. Perform fixture compensation at the device contacts of the test fixture. See [Fixture Compensation](#) for the fixture compensation procedure.
5. If user calibration in step 2 cannot be performed for some reason, set the port extension value in electrical length or delay time, which is equivalent to the electrical length between the 7-mm port of the 42942A and the device contacts of the test fixture, in place of steps 2 and 3, in accordance with [Port Extension Compensation](#).

[Other topics about Calibration](#)

F. 42941A, Probe Adapter

Perform the following calibration when a probe adapter supplied with the 42941A Impedance Probe is directly connected to the test port of the 42941A, which is connected to the four-terminal pair port of the E4990A, and a device is connected to the probe adapter.

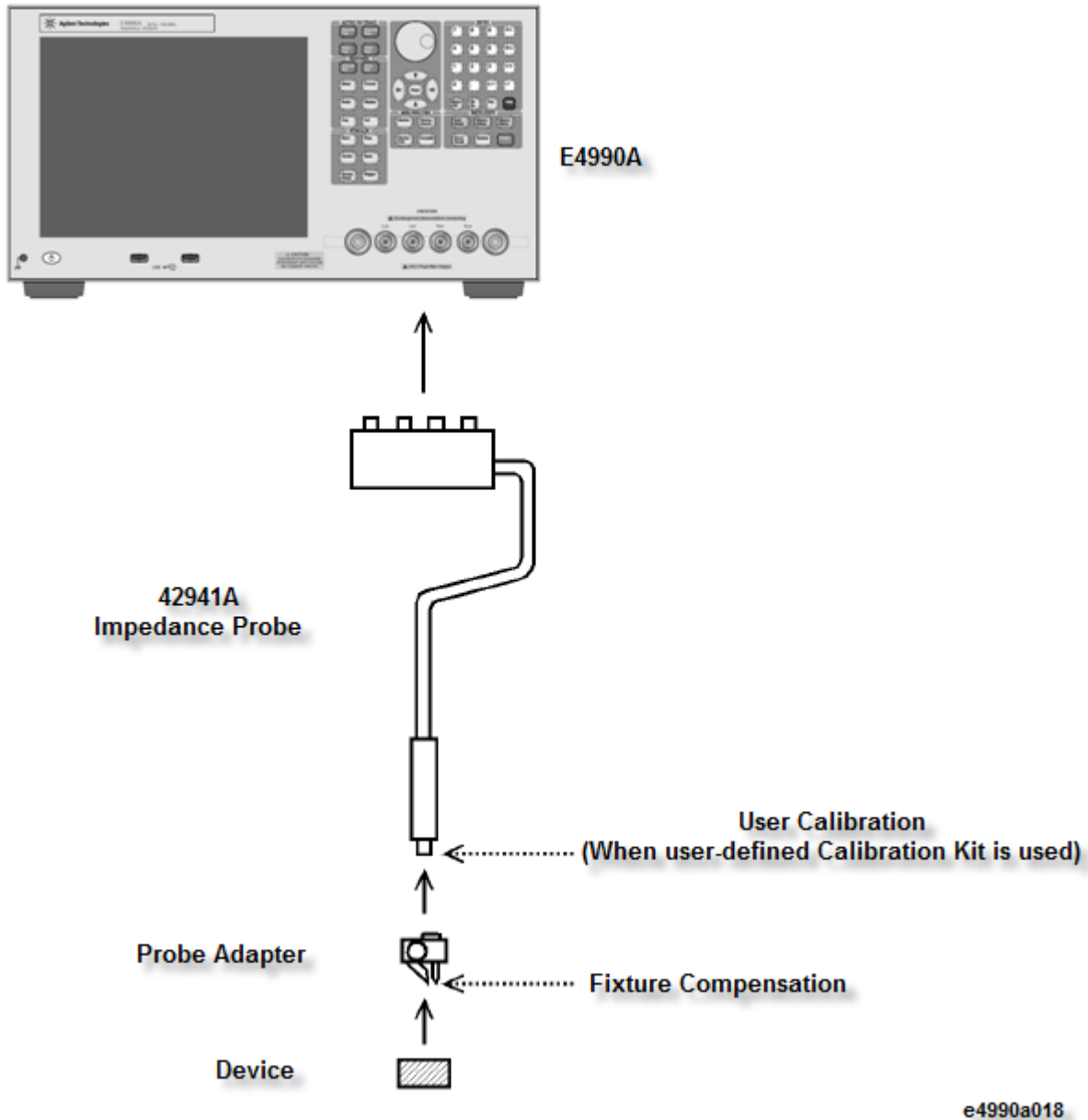

e4990a018

This calibration procedure is applied when the following probe adapters are connected to the test port of the 42941A (see the operation manual of the 42941A for details of probe adapters):

- Pin Probe (with ground electrode or ground lead)
- BNC(m) Adapter
- BNC(m) Adapter with alligator clip leads

1. Make sure that the [adapter selection](#) is set to **PROBE 42941A**. Perform [Adapter Setup](#) if it is not done yet.

E4990A Impedance Analyzer Help

2. When performing calibration at the test port of the 42941A with a user-defined calibration kit, perform user calibration with the proper calibration kit. Refer to [User Calibration](#) for the user calibration procedure. User calibration is not required when you do not use a user-defined calibration kit.
3. Connect a probe adapter to the test port of the 42941A Impedance Probe. See the operation manual of the 42941A for the appropriate connection setup.
4. Perform the fixture compensation at the device contacts (electrodes) of the probe adapter. See [Fixture Compensation](#) for the fixture compensation procedure.

NOTE

When a probe adapter is connected to the test port of a 42941A that is also connected to the four-terminal pair port of the E4990A, port extension compensation is not required.

[Other topics about Calibration](#)

G. 42941A 3.5mm Port Extension

Perform the following calibration when the 3.5-mm port of a 42941A connected to the E4990A is extended with a one-port configuration and the device is connected to the cable's end with a minimal connection.

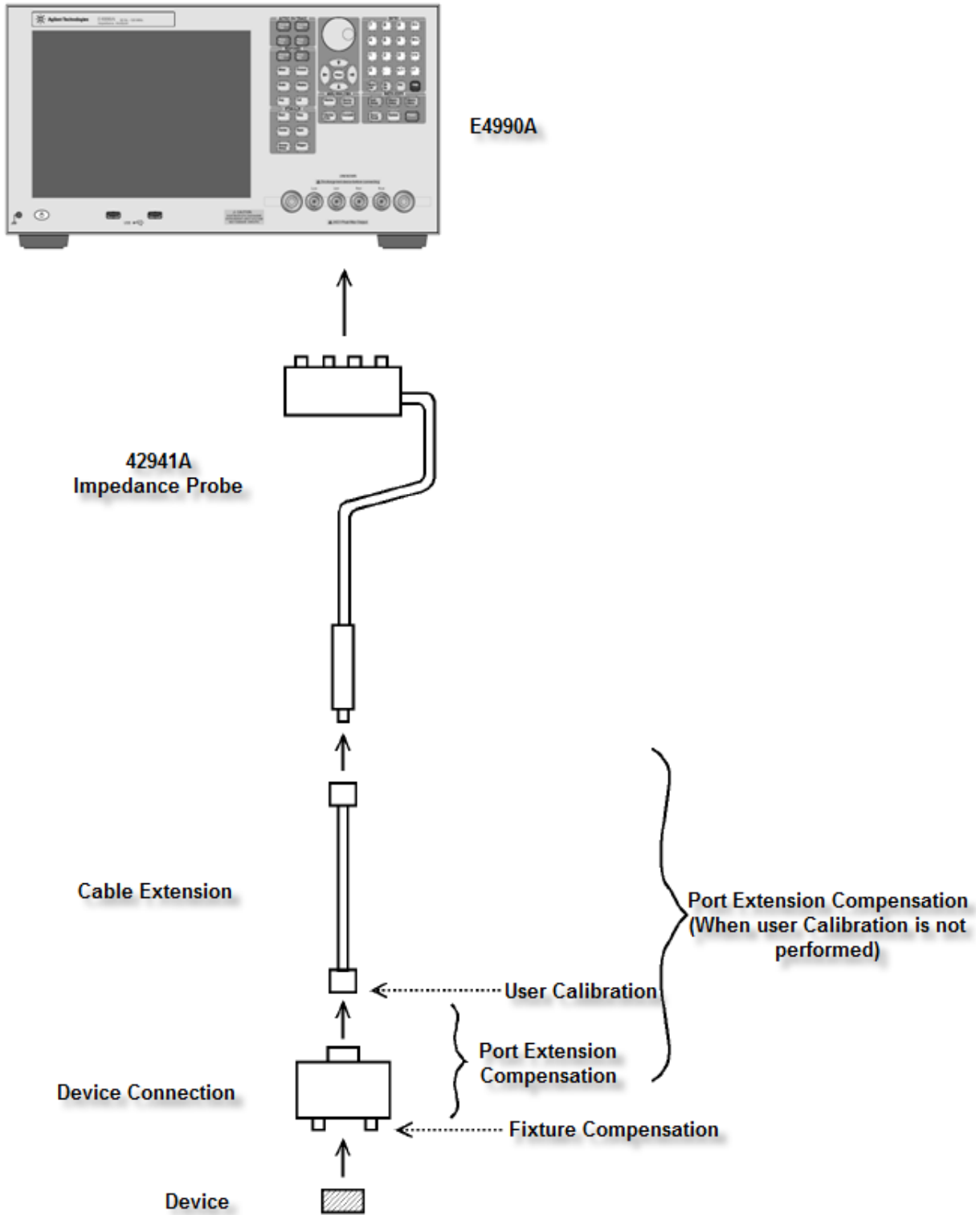

e4990a019

1. Make sure that the [adapter selection](#) is set to **42941A Extension**. Perform [Adapter Setup](#) if it is not done yet.

2. Perform the user calibration at the other end of the extended 3.5-mm port of the 42941A Impedance Probe. You can use either the calibration kit supplied or a user-defined calibration kit. See [User Calibration](#) for the user calibration procedure.
3. Set the port extension value in electrical length or delay time, which is equivalent to the electrical length between the user calibration plane and the device contacts of the test fixture, in accordance with [Port Extension Compensation](#).

NOTE

In measurements using the E4990A, the electrical length (delay time) of a 42942A dedicated test fixture (such as 16092A) and 42941A's dedicated probe adapter can be regarded as 0.

4. Perform fixture compensation at the device contacts of the test fixture. See [Fixture Compensation](#) for the fixture compensation procedure.

NOTE

If user calibration in step 2 cannot be performed for some reason, set the port extension value in electrical length or delay time, which is equivalent to the electrical length between the 3.5-mm port of the 42941A and the device contacts of the test fixture, in place of steps 2 and 3, in accordance with [Port Extension Compensation](#).

[Other topics about Calibration](#)

User Calibration

- [User Calibration Procedure](#)
- [Turning User Calibration On/Off](#)
- [Defining Standard Values for User Calibration](#)

[Other topics about Calibration](#)

User calibration can be performed only when "42942A Terminal Adapter (7mm 42942A / 42942A Extension)" or "42941A Impedance Probe (**PROBE 42941A / 42941A Extension**)" is selected in the [adapter selection](#).

User Calibration Procedure

Perform user calibration as follows:

NOTE

User calibration consists of three calibration data acquisition procedures: OPEN, SHORT, and LOAD, and you must obtain all three types of calibration data when performing user

calibration. It is not possible to turn ON or OFF each type of calibration data independently during your measurement.

1. Press **Cal** to display the Calibration Menu.
2. Select calibration (compensation) data acquisition points in accordance with [Selecting Calibration/Compensation Data Points](#).
3. Press **User Cal** to display the User Calibration Menu.
4. If required, set user-defined standard values in accordance with [Defining Standard Values for User Calibration](#).
5. Press **Execute Cal** to display the Calibration Execution Menu.
6. Connect the OPEN standard to the port (plane) where you want to perform user calibration.
7. Press **Open** to start OPEN calibration data measurement. When OPEN calibration data measurement is completed, the softkey label changes to **Open** ✓.
8. Remove the OPEN standard from the port. Then, connect the SHORT standard to the port.
9. Press **Short** to start SHORT calibration data measurement. When the SHORT calibration data measurement is completed, the softkey label changes to **Short** ✓.
10. Remove the SHORT standard from the port. Then, connect the LOAD standard to the port.
11. Press **Load** to start LOAD calibration data measurement. When LOAD calibration data measurement is completed, the softkey label changes to **Load** ✓.
12. Press **Done** to start calculating the calibration coefficient from the measured OPEN, SHORT, and LOAD standard data. The coefficient is automatically saved to the internal memory.

NOTE During the calibration data measurement, the message **Sweeping...** is displayed in the instrument state area at the bottom-left of the screen.

NOTE Press **Cancel** to cancel the user calibration process. If the user calibration process is canceled, the previously obtained data can be used as the available user calibration coefficient.

Turning User Calibration On/Off

The user calibration function is automatically turned on after completing user calibration data measurement. However, you can turn this function on or off as required.

1. Press **Cal** > **User Cal** to display the User Calibration Menu.

2. Press **Correction** > **ON|OFF** to make the user calibration available (**ON**) or not available (**OFF**) for measurement.

Defining Standard Values for User Calibration

You can define standard values of OPEN, SHORT, and LOAD for user calibration. Figure below shows the circuit models of the user calibration kit for the Keysight E4990A.

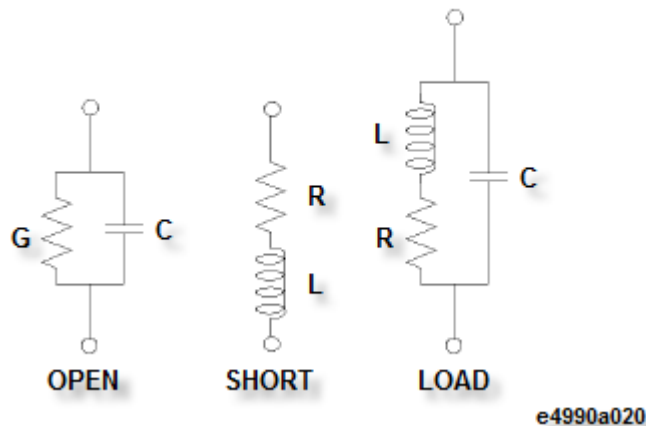

Each calibration's standard value can be confirmed and changed as follows:

1. Press the **Cal** > **User Cal** > **Define Value** to display the Calibration Data Definition Menu.
2. Select one of the calibration data definition keys, **Open Conduct (G)**, **Open Cap (C)**, **Short Resist (R)**, **Short Induct (L)**, **Load Resist (R)**, **Load Induct (L)**, or **Load Cap (C)**, to confirm or set the calibration data definition.
3. Enter the desired value to specify the calibration data definition.

Port Extension Compensation

Port extension compensation is used to compensate an error caused by the electrical delay when the 7-mm port of the 42942A Terminal Adapter or 3.5-mm port of the 42941A Impedance Probe is extended with a one-port configuration.

Port extension compensation can be performed when **42942A Extension** or **42941A Extension** is chosen in [adapter selection](#).

Perform the port extension compensation as follows:

1. Press **Cal** > **Port Extension** and input the desired port extension value.

NOTE

You can set the port extension value in either electrical length or delay time. When the port extension value is set by one of

these keys, the value is converted to the other unit and displayed on the bottom line of the setting parameter area in small letters. You can also see the converted value in the setting parameter area by pressing the other key.

2. Press **Extension** > toggle between **ON|OFF** to turn **ON/OFF** the port extension compensation.

[Other topics about Calibration](#)

Fixture Compensation

- [Fixture Compensation Procedure](#)
- [Turning the Fixture Compensation On or Off](#)
- [Defining the Standard Values for Fixture Compensation](#)

[Other topics about Calibration](#)

Fixture Compensation Procedure

Perform the fixture compensation as follows:

NOTE If the oscillator level is greater than 500 mV, an error, **REDUCE OSC LEVEL** or **BRIDGE UNBALANCED** may occur during the Short correction and measurement may not be correct. When you set the oscillator level for measurement to 500 mV or even greater, set it to 500 mV for the fixture correction.

NOTE Fixture compensation consists of three compensation data acquisition processes: OPEN, SHORT, and LOAD, but you do not need to obtain all three types of compensation data when you perform fixture compensation. Each type of compensation data can be turned on or off independently for measurement. For normal measurement, it is recommended that you perform fixture OPEN compensation and fixture SHORT compensation.

NOTE For the E4990A, because the sending and receiving ends of a measurement path are terminated with the characteristic impedance of 50 Ω at a measurement frequency of 15 MHz or higher frequency for no cable extension (direct connection type test fixture) or a measurement frequency of 5.2083 MHz or higher for 1 m/2 m cable extension, the trace may contain a gap at 15 MHz (or 5.2083 MHz). You can remove this gap by executing the Load correction.

1. Press the **Cal** key to display the Calibration Menu.
2. Select the calibration (compensation) data acquisition points in accordance with [Selecting Calibration/Compensation Data Points](#).

3. Press **Fixture Comp** to display the Fixture Compensation Menu.
4. If required, set user-defined standard values in accordance with [Defining the Standard Values for Fixture Compensation](#).

NOTE When you perform fixture LOAD compensation for the 16334A Tweezers Type Test Fixture or 16451B Dielectric Test Fixture, you need special setups and procedures for standard definition and other processes. See [Fixture Compensation When the 16451B/16334A is Used](#) for details.

5. When you complete the changes, press **Return** to return to the Fixture Compensation Menu.
6. Put the test fixture's device contacts in the OPEN state.

NOTE Refer to the operation manual furnished with each test fixture for more information on the OPEN state of the test fixture. Generally, the OPEN state can be made by connecting no device to the device contacts. If the distance between the HIGH electrode and the LOW electrode can be adjusted for a test fixture, keep the same distance as when the test device is inserted between the electrodes.

7. Press **Open** to start OPEN compensation data measurement. When OPEN compensation data measurement is completed, the softkey label changes to **Open** ✓.

8. Put the test fixture's device contacts in the SHORT state.

NOTE Refer to the operation manual furnished with each test fixture for more information on the SHORT state of the test fixture. Generally, the SHORT state can be made by connecting a high conductivity metal (shorting bar) to the device contacts or by shorting the HIGH electrode and LOW electrode directly.

9. Press **Short** to start SHORT compensation data measurement. When SHORT compensation data measurement is completed, the softkey label changes to **Short** ✓.

10. Connect a LOAD device to the test fixture's device contacts.

NOTE Refer to the operation manual furnished with each test fixture for more information on the necessity or connection of LOAD compensation.

11. Press **Load** to start LOAD compensation data measurement. When LOAD compensation data measurement is completed, the softkey label changes to **Load** ✓.

NOTE

During the calibration data measurement, the message **Sweeping...** is displayed in the instrument state area at the bottom-left of the screen.

Turning the Fixture Compensation On or Off

The fixture compensation function is automatically turned On after completing each compensation data measurement. However, you can turn the function ON or OFF as required.

1. Press **Cal** > **Fixture Comp** to bring up the Fixture Compensation Menu.
2. Toggle between **ON|OFF** at **OPEN**, **SHORT** and **LOAD** to make each fixture compensation valid (ON) or invalid (OFF) for the measurement.

Defining the Standard Values for Fixture Compensation

You can define standard values of OPEN, SHORT, and LOAD for fixture compensation. Figure below shows the circuit models of the fixture compensation kit used for the Keysight E4990A.

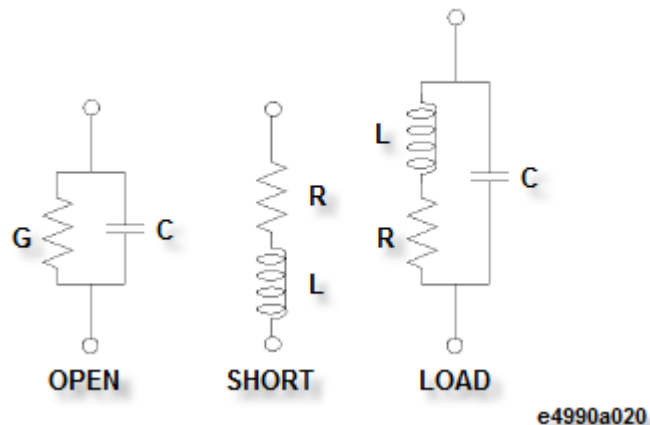

Each calibration's standard value can be confirmed and changed as follows:

1. Press the **Cal** > **Fixture Comp** > **Define Value** to display the Compensation Data Definition Menu.
2. Select one of the calibration data definition keys, **Open Conduct (G)**, **Open Cap (C)**, **Short Resist (R)**, **Short Induct (L)**, **Load Resist (R)**, **Load Induct (L)**, or **Load Cap (C)**, to confirm or set the compensation data definition.
3. Enter the desired value to specify the compensation data definition.

Selecting Calibration/Compensation Frequency Points

You can choose the type of frequency points to use in obtaining user calibration data and fixture compensation data as follows:

1. Press the **Cal** > **Compen Point** > **Fixed freq|User freq** to select the measurement points used for user calibration or those for fixture compensation.

NOTE **Fixed freq** setting always assumes OSC Level as set to 0.5 V, even if its set to any other level. If you would like to perform calibration sweep with a specific OSC level other than 0.5 V, set the calibration/compensation point to **User freq**.

Softkey	Calibration/Compensation Points
Fixed freq	Obtain calibration/compensation data at fixed frequency points covering the entire frequency range of the E4990A. In device measurement, user calibration or fixture compensation is applied to each measurement point by using interpolation. Even if the measurement points are changed by altering the sweep setups, you don't need to retake the calibration/compensation data.
User freq	Obtain calibration/compensation data at the same frequency points as used in actual device measurement, which are determined by the sweep setups. Each set of calibration/compensation data is applied to each measurement at the same point. If measurement points are changed by altering the sweep setups, calibration/compensation data may become invalid. If the span is widened, calibration/compensation data acquisition is again required. If the span is narrowed, calibration/compensation data is interpolated .

NOTE The calibration/compensation data point selection set by the **Compen Point** key is common for user calibration and fixture compensation. You cannot set the selection for either one of them independently.

NOTE When the selection of calibration/compensation data points is changed after completing user calibration or fixture compensation, the obtained user calibration or fixture compensation data become invalid. Therefore, do not change the selection of the calibration/compensation data points after completing user calibration or fixture compensation.

List of Fixed Calibration/Compensation Frequency Points

When the fixed frequency points for user calibration and fixture compensation are selected (**Compen Point** > **Fixed freq**),

calibration/compensation is performed at the frequency points listed below:

20, 50, 100, 200, 500, 1000, 1200, 1500, 1900, 2300, 2800, 3500, 4300, 5300, 6600, 8100

10k, 11k, 11.4k, 11.400001k, 12,1k, 13.3k, 14.7k, 16.2k, 17.8k, 19.6k, 21.5k, 22.9k, 22.900001k, 23.7k, 26.1k, 28.7k, 31,6k, 34.8k, 38.3k, 42.2k, 46.4k, 51.1k, 56.2k, 61.9k, 68.1k, 75k, 82.5k, 90.9k, 91.6k, 91.600001k

100k, 110k, 121k, 133k, 147k, 162k, 178k, 196k, 215k, 237k, 261k, 287k, 316k, 348k, 383k, 422k, 464k, 511k, 562k, 619k, 681k, 750k, 825k, 909k

1M, 1.1M, 1.2M, 1.3M, 1.4M, 1.4648M, 1.464800001M, 1.5M, 1.7M, 2M, 2.5M, 3M, 3.5M, 4M, 4.5M, 5M, 5.2083M, 5.208300001M, 6M, 7M, 8M, 9M

10M, 11M, 12M, 13M, 14M, 15M, 15.000000001M, 16M to 120M (1M step, 105pts)

[Other topics about Calibration](#)

Setting Up the Display of Measurement Results

Setting Up the Display of Measurement Results

This chapter describes how to configure the E4990A Impedance Analyzer to display the measurement results in the way that best suits your needs.

- [Selecting the Measurement Parameters](#)
- [Selecting the Graph Axis Format](#)
- [Scaling Trace](#)
- [Trace-based Comparison and Calculation](#)
- [Monitoring Source Signal Level](#)
- [Setting for Phase](#)
- [Setting Windows Display](#)

Selecting the Measurement Parameters

- [Selecting Parameters for both traces 1 and 2](#)

- [Selecting Parameter Independently](#)

[Other topics about Setting Up the Display of Measurement Results](#)

Selecting Parameters for both traces 1 and 2

1. Press the **Meas** > **Trace1&2**.
2. Select the measurement parameter for the traces 1 and 2.

To select:		Press:
Trace A	Trace B	
Absolute impedance value	Impedance phase	$ Z - \theta_z$
Equivalent series resistance	Equivalent series reactance	R - X
Equivalent series inductance	Equivalent series resistance	Ls - Rs
Equivalent series inductance	Q value (Quality factor)	Ls - Q
Equivalent series capacitance	Equivalent series resistance	Cs - Rs
Equivalent series capacitance	Q value (Quality factor)	Cs - Q
Equivalent series capacitance	Dissipation factor	Cs - D
Absolute admittance	Admittance phase	$ Y - \theta_y$
Equivalent parallel conductance	Equivalent parallel susceptance	G - B
Equivalent parallel inductance	Equivalent parallel conductance	Lp - G
Equivalent parallel inductance	Q value (Quality factor)	Lp - Q
Equivalent parallel capacitance	Equivalent parallel conductance	Cp - G

Measurement

Equivalent parallel capacitance	Q value (Quality factor)	Cp - Q
Equivalent parallel capacitance	Dissipation factor	Cp - D
Absolute impedance value	Equivalent series inductance	Z - Ls
Absolute impedance value	Equivalent series capacitance	Z - Cs
Absolute impedance value	Equivalent parallel inductance	Z - Lp
Absolute impedance value	Equivalent parallel capacitance	Z - Cp
Absolute impedance value	Equivalent series resistance	Z - Rs
Absolute impedance value	Q value (Quality factor)	Z - Q
Absolute impedance value	Dissipation factor	Z - D
Equivalent parallel inductance	Equivalent parallel resistance	Z - Y

NOTE

The E4990A preserves the graph axis formats, scale settings, data and memory trace contents, and trace definitions for each parameter (for example, Ls) unless it is turned Off or reset to its preset state. This feature makes it easy to examine the DUT from various perspectives by switching among a number of measurement parameters. For detailed information on configuring the settings that control how the E4990A displays measurement results, refer to the following sections:

- [Selecting the Graph Axis Format](#)
- [Auto-scaling the Trace](#)
- [Manual Scale Setting \(for measurements other than COMPLEX Z-Y\)](#)
- [Manually Scaling the Active Trace for a COMPLEX Z-Y Graph](#)
- [Trace-based Comparison and Calculation](#)

You can set each measurement parameter without specifying the active trace or checking its current state.

Selecting Parameter Independently

You can select the measurement parameter for each trace independently.

1. Press **Meas** > **Trace 1**, **Trace 2**, **Trace 3** or **Trace 4**. When you set the trace 3 or 4, increase the [number of trace](#).
2. Select the desired measurement parameter for the trace.

NOTE

Vdc and Idc can be selected when the [sweep type](#) is set at either DC Bias or Log DC Bias.

Selecting the Graph Axis Format

- [When Using Cartesian Coordinates](#)
- [When Using Complex Parameters \(COMPLEX Z-Y\)](#)

[Other topics about Setting Up the Display of Measurement Results](#)

When Using Cartesian Coordinates

Unless the E4990A is configured to perform a COMPLEX Z-Y measurement (complex impedance for Trace 1, complex admittance for Trace 2), it displays measurement results in a Cartesian-coordinate graph whose horizontal and vertical axes indicate the sweep and measurement parameter values, respectively. Use the following procedure to select the vertical axis format for a Cartesian-coordinate graph:

1. Activate the trace for which you want to set the axis format.
2. Press the **Format** key to display the Format menu.
3. Select the desired vertical axis format by pressing the appropriate key, **Linear|Log**.

NOTE

The horizontal axis format is automatically determined based on the selected sweep type.

When Using Complex Parameters (COMPLEX Z-Y)

When the Keysight E4990A is configured to perform a COMPLEX Z-Y measurement (complex impedance for Trace A, complex admittance for Trace B), use the following procedure to select the graph axis formats:

1. Activate the trace for which you want to set the axis format.
2. Press **Format** > **Complex Format**.
3. Select the desired graph axis format by pressing the appropriate key, **Complex|Polar**.

Scaling Trace

- [Auto-scaling the Trace](#)
- [Manual Scale Setting \(for measurements other than COMPLEX Z-Y\)](#)
- [Manually Scaling the Active Trace for a COMPLEX Z-Y Graph](#)
- [Scaling Trace with Reference Tracking](#)

[Other topics about Setting Up the Display of Measurement Results](#)

Auto-scaling the Trace

Auto-scaling for active trace

1. Activate the trace you want to auto-scale.
2. Press **Scale** > **Auto Scale** to auto-scale the specific active trace. This adjusts the scale of the trace so that you can easily examine the overall characteristics while making all of the data visible within the graph.

Auto-scaling for all traces

1. Activate the trace you want to auto-scale.
2. Press **Scale** > **Auto Scale All** to auto-scale the all the traces.

Manual Scale Setting (for measurements other than COMPLEX Z-Y)

This section describes how to manually scale the active trace for a Cartesian-coordinate graph. Note that these procedures do not apply when the Keysight E4990A is configured to perform a COMPLEX Z-Y measurement (complex impedance for Trace 1, complex admittance for Trace 2).

Scaling the Trace Based on the Reference Line and Resolution per Division

When the vertical axis is linear, you can scale the trace by first specifying where to position the reference line and what value to assign to it and then setting the scale for each division.

1. Activate the trace you want to manually scale.
2. Press **Scale** > **Reference Position**, and input the desired value that represents where the reference line should be positioned in relation to the bottom of the graph. This value ranges from 0 (bottom) and 10 (top). In the preset state, the reference line position defaults to 5, which means that it is displayed at the center of the graph.

NOTE

The reference line is a horizontal dotted line displayed in the same color as the corresponding trace.

3. Press **Scale** > **Reference Y Value**, the input the desired value that indicates the reference value, that is, the value of the measurement parameter that corresponds to the reference line position.

4. Alternatively, when you have the main marker displayed on the trace, press **Marker Fctn** > **Marker Reference** to use the value at the marker position as the reference value. Thus, you can change the trace scale by placing the reference line at the position indicated by the main marker.
5. Press the **Scale** > **Scale/Div**, and input the desired value that indicates the scale per division.

Scaling the Trace Based on the Top and Bottom Values

When the vertical axis is set to logarithmic, you can scale the trace by specifying the highest (top) and lowest (bottom) values displayed within the graph.

1. Activate the trace you want to manually scale.
2. Press **Scale** > **Log-Y Top** and input the desired value indicating the top value to be displayed on the graph.
3. Press **Scale** > **Log-Y Bottom** and input the desired value indicating the bottom value to be displayed on the graph.

Manually Scaling the Active Trace for a COMPLEX Z-Y Graph

Scaling the Active Trace for a Complex Plane

When your graph is a complex plane, you can manually scale the active trace by specifying the reference values for the vertical and horizontal axes as well as the scale per division.

1. Activate the trace you want to manually scale.
2. Press **Scale** > **Reference X Value**, and input the desired value that indicates the reference value for the horizontal (X) axis. This value is a real value. The reference line for the horizontal axis in a complex plane is stationary in the center of the axis.
3. Press **Scale** > **Reference Y Value**, and input the desired value that indicates the reference value for the vertical (Y) axis. This value is a complex value. The reference line for the vertical axis in a complex plane is stationary in the center of the axis.
4. Press the **Scale** > **Scale/Div**, and input the desired value that indicates the scale per division. For a complex plane, both the vertical and horizontal axes use the same scale per division.

Scaling the Active Trace for a Polar Chart

When your graph is a polar chart, you can scale the active trace by specifying the full scale value, that is, the distance from the origin to the outermost circle.

1. Activate the trace you want to manually scale.

2. Press **Scale** > **Divisions**, and input the desired value that indicates the full scale value. Divisions defines the number of divisions on the Y-axis. An even number from 4 to 30 can be used.
3. Alternatively, when you have the main marker displayed on the trace, press **Marker Fctn** > **Marker Reference** to use the value at the marker position (i.e., the distance from the origin) as the full scale value. Thus, you can change the trace scale by placing the full scale circle at the position indicated by the main marker.

Scaling Trace with Reference Tracking

1. Activate the trace you want to perform reference tracking.
2. Press **Scale** > **Reference Tracking**.
3. Press **Tracking** > **OFF|Track Peak|Track Freq** to select between turning OFF the reference tracking option, track by peak reference or track by frequency.
4. Press **Track Frequency**, and input the desired frequency value.

Trace-based Comparison and Calculation

- [Identifying Differences between Data and Memory Traces through Comparison or Calculation](#)
- [Subtracting an Offset Value](#)

Other topics about Setting Up the Display of Measurement Results

Traces 1 and 2 each provide two different trace types: data and memory. The data trace keeps track of the DUT's characteristics as it is being tested, while the memory trace captures the measurement data at a specific point in time and displays that data. With the data trace, you can perform a simple calculation on the measurement data and display the results. For example, you can display the differential between the measured data and the memory trace data or the result of subtracting your specified offset value from the measured data. Table below lists the trace types and their functions:

Trace Types		Function
Trace 1	Data trace (yellow)	Displays measurement data/calculations (updated during measurement cycle)

	Memory trace (green ¹)	Stores and displays previously measured data (captured during measurement cycle) Display > Data -> Memory is selected)
Trace 2	Data trace (blue ¹)	Displays measurement data/calculations (updated during measurement cycle)
	Memory trace (brown ¹)	Stores and displays previously measured data (captured during measurement cycle) Display > Data -> Memory is selected)

¹ Factory default settings.

These features add flexibility to your testing task; for example, on the same screen you can compare the data and memory traces with each other or simultaneously display the results of a calculation as shown by the data and memory traces.

Identifying Differences between Data and Memory Traces through Comparison or Calculation

1. Activate the trace for which you want to perform calculation or comparison between the two trace types.
2. Press the **Display** key to display the Display menu.
3. Press **Display > Data**.
4. Start testing the DUT so that the data trace displays the results.
5. At this time, you may want to hold (stop) the sweep cycle for the data trace by pressing **Trigger > Hold**. Doing so ensures that you can create an exact snapshot of the measurement data when you later store the data into the memory trace.
6. Press **Data -> Memory** to store the measurement data into the memory trace.

NOTE

When you press **Data -> Memory**, the memory trace captures the measurement data exactly as it is displayed on screen. The memory trace always stores measurement data, even when the data trace is displaying the results of a calculation. Note that while the subtraction of the offset value is being executed, the resulting subtraction is stored in the memory trace. The **Data -> Memory** key affects both Traces 1 and 2. This means that the measurement data for the non-active trace is also stored into the memory trace.

7. The Keysight E4990A provides a number of options that allow you to control how each trace is displayed. Select one of the following display options by pressing the appropriate key:

Softkey	Function
Data	Displays only data trace on the screen
Mem	Displays only memory trace stored by Data -> Mem operation on the screen
Data & Mem	Displays data trace and memory trace on the screen. You can now easily compare the data trace and memory trace on the screen.
Off	Trace is not displayed

7. Start testing the DUT to obtain the measurement data for comparison or calculation with the reference measurement data you stored into the memory trace (if the sweep cycle is in the hold state, you can restart the measurement by pressing **Trigger**).

Subtracting an Offset Value

You can specify an offset value to be subtracted from the measurement data, and the result of this operation is displayed by the data trace.

1. Press **Display** > **Data -> Mem** to store the measured data in memory.
2. Press **Data Math Offset** and input the desired offset value (the offset value defaults to zero in the preset state).
3. Press **Data Math**.
4. Select the data math operation to perform.

Softkey	Function
OFF	Turns off data math functions (Do not perform data math)
Data / Mem	Divides measured data by memory trace and stores result in data trace
Data * Mem	Multiplies data trace by memory trace and stores result in data trace

Data - Mem	Subtracts memory trace from data trace and stores result in data trace
Data + Mem	Adds data trace and memory trace and stores result in data trace

5. Press **Display**.
6. Select the type of data on display ON the screen.
7. Send the trigger to make measurements.

Monitoring Source Signal Level

- [Monitoring the Test Signal Level \(AC\)](#)
- [Monitoring the dc Bias Level](#)

[Other topics about Setting Up the Display of Measurement Results](#)

Monitoring the Test Signal Level (AC)

The signal level actually applied to a DUT differs from the setting applied to the signal source because some electrical loss occurs between each test terminal and the DUT. The E4990A provides a feature that allows you to monitor both the voltage and amperage values of the test signal level actually applied to the DUT, whether you measure the signal source level by voltage or current. This feature is called "test signal level monitor".

1. Press the **Meas** key to display the Measurement menu.
2. Press **OSC Monitor Trace > Vac - Iac** to turn ON the OSC monitoring trace for test signal level (AC)

NOTE Vac and Iac can be assigned for traces 1 to 4 independently by pressing **Meas > Trace 1, Trace 2, Trace 3 or Trace 4**.

1. Press **OSC Monitor Trace > Close** to turn OFF the monitoring feature.

Monitoring the DC Bias Level

In most cases, the DC bias level actually applied to a DUT differs from the setting applied to the dc bias source because some electrical loss occurs between each test terminal and the DUT. The E4990A provides a feature that allows you to monitor either the voltage or amperage value of the dc bias actually applied to the DUT. This feature is called the "DC bias level monitor."

Monitoring the Test Signal at Sweep Start

You can monitor the dc bias level (either voltage or amperage) at the beginning sweep through the dc Voltage/Current Bias Monitor field, which

is located in the right-upper part of the screen LCD and labeled **DCV**, **DCI**. This field is updated at each sweep.

1. Press **Meas** key to display the Measurement menu.
2. Press **DC Monitor Setup > DC Monitor > ON**, to turn ON the DC monitoring feature.

Monitoring the DC Bias Level with Trace

You can monitor the actual dc bias level (either voltage or amperage) at the each point when dc bias sweep is selected.

1. Press **Sweep Setup > Sweep Type > DC Bias** or **Log DC Bias** to setup type to DC Bias sweep setting.
2. Press **Meas > DC Monitor Setup > DC Monitor Trace > Vdc - Idc** to turn ON the DC monitoring trace feature. The traces 3 and 4 are displayed and assigned to Vdc and Idc respectively.

NOTE Vdc and Idc can be assigned for traces 1 and 2 by pressing **Meas > Trace 1, Trace 2**.

1. Press **DC Monitor Setup > DC Monitor Trace > Close** to turn OFF the DC monitoring trace feature.

Setting for Phase

- [Selecting the Phase Unit](#)
- [Displaying Phase Values without Wrapping at \$\pm 180\$ degree](#)

[Other topics about Setting Up the Display of Measurement Results](#)

Selecting the Phase Unit

When you are performing phase-based measurement, you can specify whether to use degrees or radian as the phase unit applied to the scaling and marker features.

1. Activate the trace for which you want to set the phase unit.

NOTE To set the phase unit, your parameter must be either $|Z|-\theta/|Y|-\theta$ or COMPLEX Z-Y. You should activate Trace 2 in the former case, and the trace whose axis format is polar in the latter case.

2. Press the **Format** key to display the Format menu.
3. Press **Phase Unit > Deg|Rad** to select your desired phase unit.

Displaying Phase Values without Wrapping at ± 180 degree

The E4990A provides a feature that allows you to display phase values without wrapping them at $+180^\circ$ or -180° . This feature, called "expanded phase," is useful when measured phase values are in a continuous increase or decrease and some of them exceed $+180^\circ$ or -180° . To set up the expanded phase feature, follow these steps:

1. Activate the trace for which you want to use the expanded phase feature.

NOTE

To expand the phase, your parameter must be either $|Z|-\theta/|Y|-\theta$ or COMPLEX Z-Y. You should activate Trace 2 in the former case, and the trace whose axis format is polar in the latter case.

2. Press the **Format** key to display the Format menu.
3. Press **Expand Phase** > **ON|OFF** to turn On or Off the expanded phase feature.

Setting Windows Display

- [Maximizing the specified window trace display](#)
- [Turning off the display of graticule labels](#)
- [Hiding frequency information](#)
- [Updating data on real time](#)
- [Labeling a window](#)
- [Setting display colors](#)
- [Setting display magnification](#)
- [Resizing the screen](#)
- [Superimposing Multiple Traces](#)

[Other topics about Setting Up the Display of Measurement Results](#)

Maximizing the specified window/trace display

When using multiple channels, it is possible to maximize a specific channel window on the screen. When multiple traces are displayed in a channel window, it is also possible to maximize a specific trace displayed within that channel window.

NOTE

The Window/Trace Display data can be preset to factory settings using the [Preset](#) option.

Maximizing a window

1. Press **Channel Next** (or **Channel Prev**) to select the channel of which window will be maximized.
2. Press **Channel Max** to maximize the channel window.
3. Press **Channel Max** one more time to reduce the window to its previous size.

Maximizing a trace display

1. Press **Channel Next** (or **Channel Prev**) to select the channel to which the trace belongs.

2. Press **Trace Next** (or **Trace Prev**) to select the trace of which display will be maximized.
3. Press **Trace Max** to maximize the trace display.
4. Press **Trace Max** one more time to reduce the display to its previous size.

Turning off the display of graticule labels

When using a rectangular display format, the graph area can be expanded to the left by turning OFF the display of graticule labels.

Turning OFF graticule label display

1. Press **Channel Next** (or **Channel Prev**) to select the channel of which graticule label display will be turned ON or OFF.
2. Press **Display**.
3. Click **Graticule Label** to turn graticule label display ON or OFF.

Hiding frequency information

You can hide the frequency information from the screen in order to ensure its confidentiality or for other reasons.

Hiding Frequency Information on the Screen

Follow the steps below to hide frequency information on the measurement screen.

1. Press **Display** key.
2. Click **Frequency** to turn OFF the frequency display.

NOTE

Turning OFF the frequency display using **Display** > **Frequency** key does not erase the frequency display within the **Stimulus** softkey, which is turned on by pressing **Start**, **Stop**, **Center**, and **Span**. The display of the softkey bar itself can be switched ON or OFF by pressing **Softkey On/Off**.

Hiding Softkey's Frequency Information

You can delete the frequency information from the measurement screen, which changes the frequency information displayed in the Stimulus softkey and the data entry area for Hz unit to asterisks (**).

1. Press **System** key.
2. Click **Service Menu**, then click **Security Level** and select any of the following options for the frequency display.

Sofkey	Function
None	Displays the frequency information.

Low	<p>Hides the frequency information with a series of asterisks.</p> <p>Save/Recall > Save Trace Data and Save S1P are inactive. This can be turned OFF by the Security Level menu.</p>
High	<p>Hides the frequency information with a series of asterisks.</p> <p>Save/Recall > Save Trace Data and Save S1P are inactive. This cannot be turned OFF by the Security Level menu. Resetting to OFF is only possible by executing Preset or Recall.</p>

Updating data on real time

You can choose to display the data on the screen on real time.

1. Press **Display** > **Update** > **ON** to turn ON the feature to display the data on the screen on real time.
2. Press **Display** > **Update** > **OFF** to disable this features.

Labeling a window

It is possible to assign a unique name to a channel and display it on the screen. This feature is useful in saving and/or printing measurement results for future reference.

Labeling a window

1. Press **Channel Next** (or **Channel Prev**) to select the channel to be labeled.
2. Press **Display** > **Edit Title Label**, and the title label input dialog box appears.

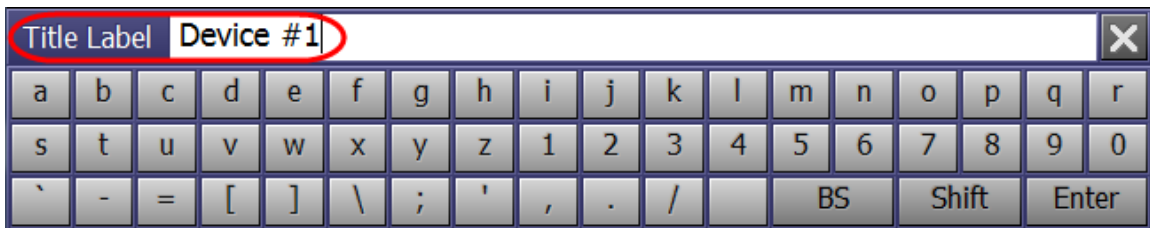

e4990a063

3. Using the keys in the dialog box, type a label and click **Enter**.
4. Click **Title Label** to turn ON the title display. The title appears within a frame at the top of the channel window.

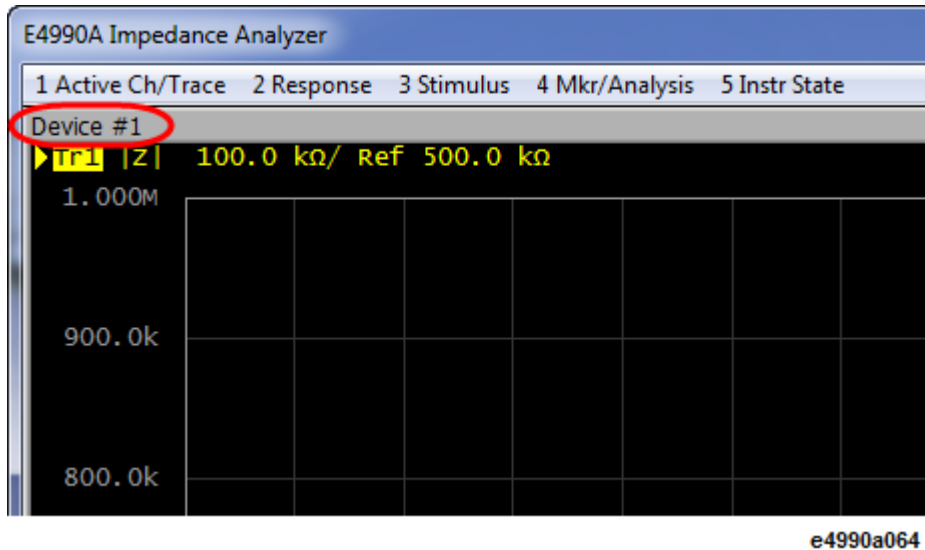

Setting display colors

Selecting display mode

You can select the display mode of the LCD display from two modes: normal display (background: black) or inverted display (background: white). In normal display, the colors of items are preset so that you can recognize them easily on the display of the instrument. On the other hand, in inverted display, they are preset to colors obtained by inverting the default settings to the normal display so that you can use data easily when storing it into a graphic file.

The selection procedure is as follows:

1. Press **Display**.
2. Click **Invert Color** to select the display color. OFF indicates the normal display; ON the inverted display.

Setting display color for each item

You can set the display color to the normal display or inverted display separately for each of the following items:

- Data/memory trace
- Labels and lines of graphs
- File display of the limit test and limit lines
- Background

Set the color of each item by specifying the amounts of red (R), green (G), and blue (B) contained in the color. You can specify each level of R, G, and B in 6 steps (0 to 5). Therefore, total of 216 colors are available by combining them. The table below shows the R, G, and B values for the main colors as a reference.

	R	G	B		R	G	B		R	G	B
White	5	5	5	Gray	2	2	2	Black	0	0	0
Light Red	5	3	3	Red	5	0	0	Dark Red	2	0	0
Light Yellow	5	5	3	Yellow	5	5	0	Dark Yellow	2	2	0
Light Green	3	5	3	Green	0	5	0	Dark Green	0	2	0
Light Cyan	3	5	5	Cyan	0	5	5	Dark Cyan	0	2	2
Light Blue	3	3	5	Blue	0	0	5	Dark Blue	0	0	2
Light Magenta	5	3	5	Magenta	5	0	5	Dark Magenta	2	0	2

The setting procedure is as follows:

1. Press **System** > **Misc Setup** > **Display Setup** > **Color Setup**.
2. Click **Normal** (for normal display) or **Invert** (for inverted display).
3. Click the softkey corresponding to the item of which you want to set the display color.

Softkey	Function
Data Trace 1 to 4	Specifies the data trace of traces 1 to 4.
Mem Trace 1 to 4	Specifies the memory trace of traces 1 to 4.
Graticule Main	Specifies the graticule label and the outer lines of graphs.

Graticule Sub	Specifies the grid of graphs.
Limit Fail	Specifies the fail display in the limit test result.
Limit Line	Specifies the limit line.
Background	Specifies the background.

4. Click **Red** (or, **Green**, or **Blue**).
5. Select the amount of the selected color from 0 to 5.

Resetting the display colors to the factory state

You can reset the display colors in normal display and inverted display to the preset factory state.

The selection procedure is as follows:

1. Press **System** > **Misc Setup** > **Display Setup** > **Color Setup**.
2. Click **Normal** (for normal display) or **Invert** (for inverted display).
3. Click **Reset Color** > **OK**.

Setting display magnification

You can reset the display magnification to Small, Normal or Large.

The selection procedure is as follows:

1. Press **System** > **Misc Setup** > **Display Setup** > **Magnification**.
2. Click **Normal**, **Small** or **Large**.

Resizing the screen

You can resize the E4990A screen by minimizing, maximizing or restoring it to its original size.

The resizing procedure is as follows:

1. Click **Resize** at the top right corner of the screen.

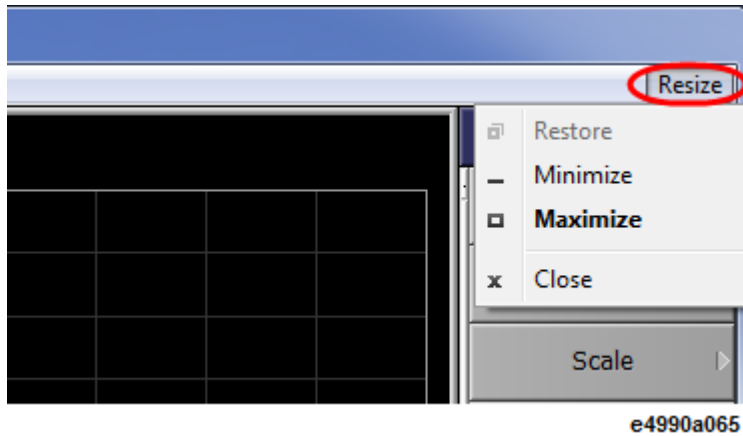

2. A drop-down menu prompts and the available options are:

Softkey	Function
Restore	Restores the screen to its default size.
Minimize	Minimizes the screen.
Maximize	Displays the screen in full page size.

3. Click **Restore**, **Minimize** or **Maximize**.

4. When the screen is resized according to an option, the related softkey is disabled. For example, when the screen is displayed in full page size, **Maximize** is disabled.

Another option to minimize the E4990A screen is by using the Menu Bar and the procedure is as follows:

1. Press **Display** > **Minimize E4990A**.

You can also hide and restore the title bar of the E4990A screen and the procedure is as follows:

1. Press **Display** > **E4990A Title bar**.

2. Click **ON** to restore the title bar.

3. Click **OFF** to hide the title bar.

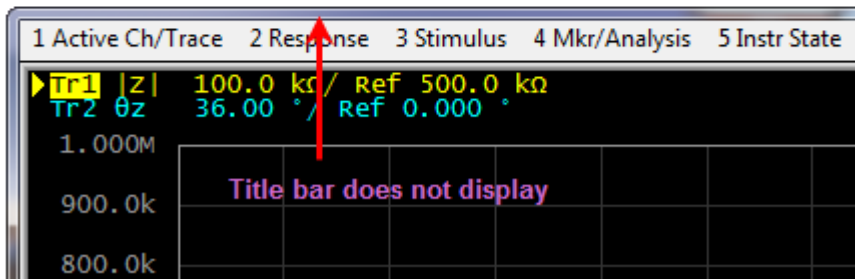
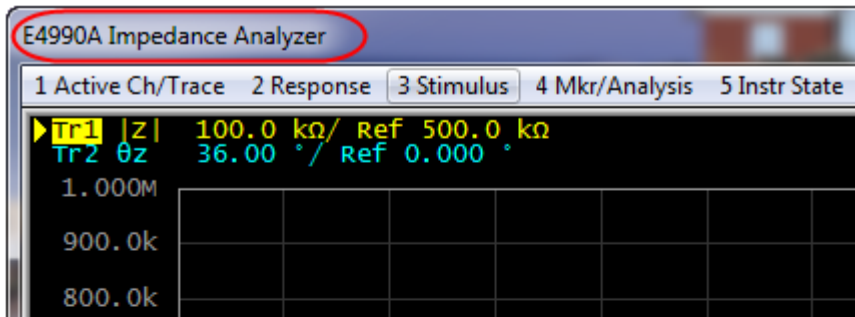

e4990a070

Superimposing Multiple Traces

This function allows you to draw a new trace without erasing existing traces. Even if this function is on, the traces are erased when the window size, scale, softkey display on/off, entry window on/off are changed.

1. Press **System** > **Service Menu** > **Accumulate** to toggle on/off.

Analysis and Processing of Result

Analysis and Processing of Result

- [Analyzing Data on the Trace using the Marker](#)
- [Searching for Positions that Match Specified Criteria](#)
- [Analyze Trace Bandwidth](#)
- [Reading the Marker Position Time or Relaxation Time](#)
- [Analyzing the Equivalent Circuit and Simulate the Frequency Characteristics](#)
- Calculating the Mean Value, Standard Deviation, and p-p of the Trace

- [Calculating Several Traces \(Equation Editor\)](#)
- [Making Pass/Fail Evaluation \(Limit Test\)](#)

Analyzing Data on the Trace Using the Marker

- [About Marker Functions](#)
- [Reading Marker Values on Trace](#)
- [Reading Relative Value from Reference Point on Trace](#)
- [Reading Actual Measurement Point/Value Interpolated between Measurement Points](#)
- [Setting up Markers for Each Trace/Setting up Markers for Coupled Operation between Traces](#)
- [Listing Marker Values in All Displayed Channels](#)
- [Specifying Display Position of Marker Values](#)
- [Aligning Marker Value Display](#)
- [Displaying All Marker Values for Displayed Traces](#)

[Other topics about Analysis and Processing of Result](#)

About Marker Functions

The marker can be used in the following ways:

- Reading a measured value as numerical data (as an absolute value or a relative value from the reference point)
- Moving the marker to a specific point on the trace (marker search)
- Analyzing trace data to determine a specific parameter
- Using the value of the marker to change the stimulus (sweep range) and scale (value of the reference line)

For the procedure used to change the sweep range and scale by using the marker, refer to [Setting the Sweep Range Using the Marker](#) and [Converting From a Reference Point to a Relative Value](#).

The E4990A is capable of displaying up to 10 markers including the reference marker on each trace. Each marker has a stimulus value (the value on the X-axis in rectangular display format) and a response value (the value on the Y-axis in rectangular display format). The Smith chart and polar formats have two marker response values each (log amplitude and phase).

Reading Marker Values on Trace

You can read the value of a marker displayed on the trace.

In rectangular display format, the marker response value is always in the same data format as that of the Y-axis. On the contrary, one format of the

marker response values (two values: main and auxiliary) can be selected from several types. The selection is performed in the data format.

Softkey for selecting data format	Marker response value	
	Main	Auxiliary
Complex	Real part (R or G)	Imaginary part (X or B)
Polar	Absolute value ($ Z $ or $ Y $)	Phase (θ_Z or θ_Y)

To set up phase unit, refer to [Selecting the Phase Unit](#).

When the span is set at 9, the stimulus value of marker show the measurement point number. When **Marker Fctn** > **Discrete** is OFF, the interpolated stimulus value is displayed between points.

Activating the marker on the Trace

1. Press **Channel Next** (or **Channel Prev**) and **Trace Next** (or **Trace Prev**) to activate the channel on which a marker is used.
2. Press **Marker** key. At this point, marker 1 is turned on and becomes active (you can operate the marker). When using marker 1, you can omit the next step.
3. Select a marker and turn it ON. The softkey used to turn on a marker is also used to activate that marker.

Moving the marker

1. Change the marker stimulus value. This operation enables you to move the marker to a point on the selected trace.
2. Read the marker stimulus value and marker response value displayed in the upper-left part of the trace screen.

Turning off the marker

1. Press **Marker** key.
2. Click **Clear Marker Menu** and then click one of the options.

NOTE

In the preset configuration, the marker settings on traces in a channel are coupled (Marker Couple is turned on). For marker coupling, refer to [Setting up markers for each trace/Setting up markers for coupled operations between traces](#).

Reading Relative Value from Reference Point on Trace

You can convert the marker reading into a relative value from the reference point.

Reference Marker Mode: OFF

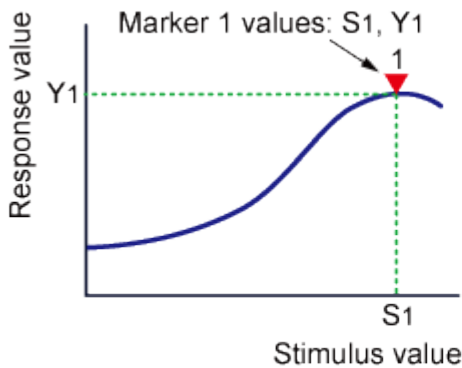

Reference Marker Mode: ON

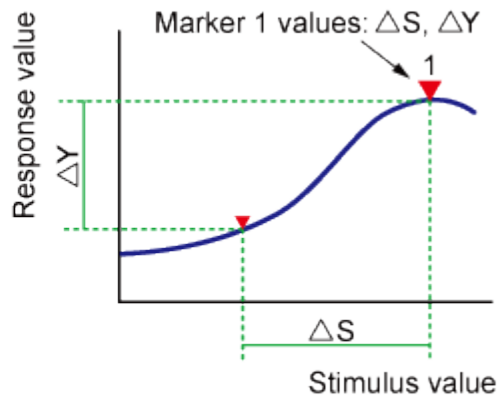

e5071c310

Converting From a Reference Point to a Relative Value

1. [Activate the reference marker.](#)
2. Move the reference marker at the point to be used as the reference.
3. Click **Ref Marker Mode** to turn on the reference mode.
4. With the reference mode turned ON, the stimulus values and response values are indicated in relative values referred to by the position of the reference marker.
5. Activate your desired marker, then move it to your desired position.

NOTE

Pressing **Marker > Marker -> Ref Marker** enables you to place the reference market at the position of the currently active marker. The reference mode then turns ON automatically.

Reading Actual Measurement Point/Value Interpolated between Measurement Points

The point on the trace on which a marker can be placed differs depending on how the discrete marker mode is set up.

Value	Description
Turning on discrete mode (Discrete ON)	A marker moves only between actual measurement points. When a specific marker's stimulus value is specified as a numerical value, the marker is placed at the measurement point closest to the specified value. A marker placed between interpolated points with the discrete mode OFF automatically moves to the nearest measurement point when the discrete mode is turned ON.

<p>Turning off discrete mode</p> <p>(Discrete OFF)</p>	<p>The marker can move from one actual measurement point to another. Because it is interpolated, it can also move in the space between measurement points.</p>
---	--

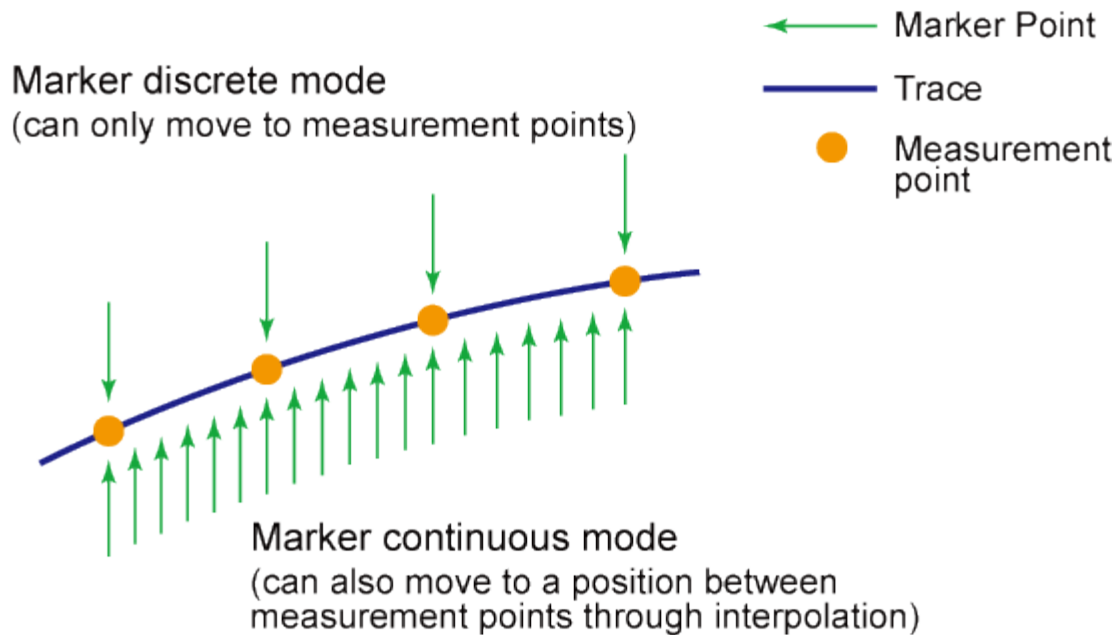

e5071c311

Turning Discrete Mode On or Off

1. Press **Channel Next** (or **Channel Prev**) and **Trace Next** (or **Trace Prev**) to activate the trace on which the discrete mode is set up.
2. Press **Marker Fctn**.
3. Click **Discrete** to turn the discrete mode ON or OFF.

Setting up Markers for Each Trace/Setting up Markers for Coupled Operation between Traces

Markers can be set up and moved either in coupled operation for all traces in a channel or independently for each trace.

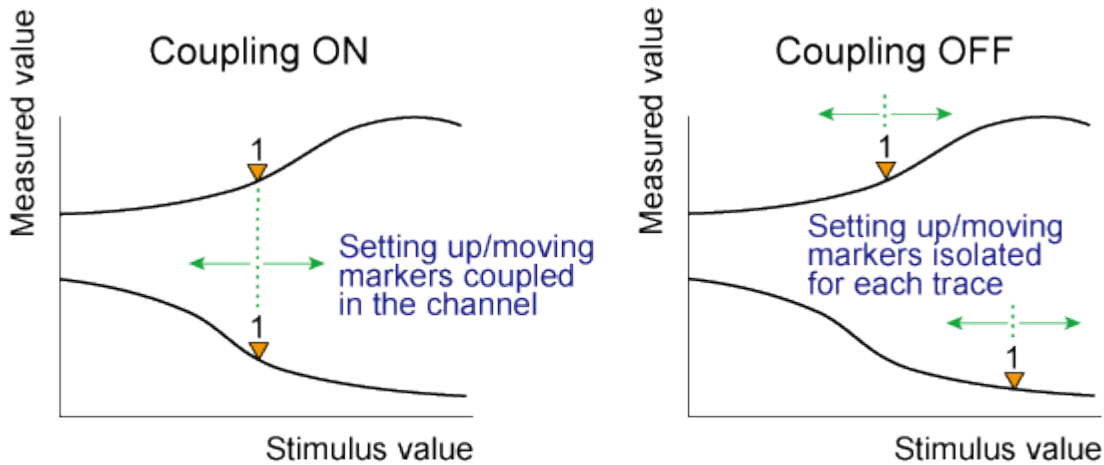

e5071c388

Value	Description
Marker Couple is ON (Coupling ON)	Markers are set up and moved in coupled operation on all the traces in a channel.
Marker Couple is OFF (Coupling OFF)	Markers are set up and moved independently for each trace.

Turning Marker Coupling On or Off

1. Press **Channel Next** (or **Channel Prev**) to activate the channel on which the marker couple is set.
2. Press **Marker Fctn**.
3. Click **Couple** to turn the marker coupling ON or OFF.

Listing Marker Values in All Displayed Channels

You can list all of the marker values in all of the displayed channels on the screen.

Turning ON the Marker Table Display

1. Press **Marker Fctn**.
2. Click **Marker Table** to turn ON the marker table display.

The marker table appears in the lower part of the screen.

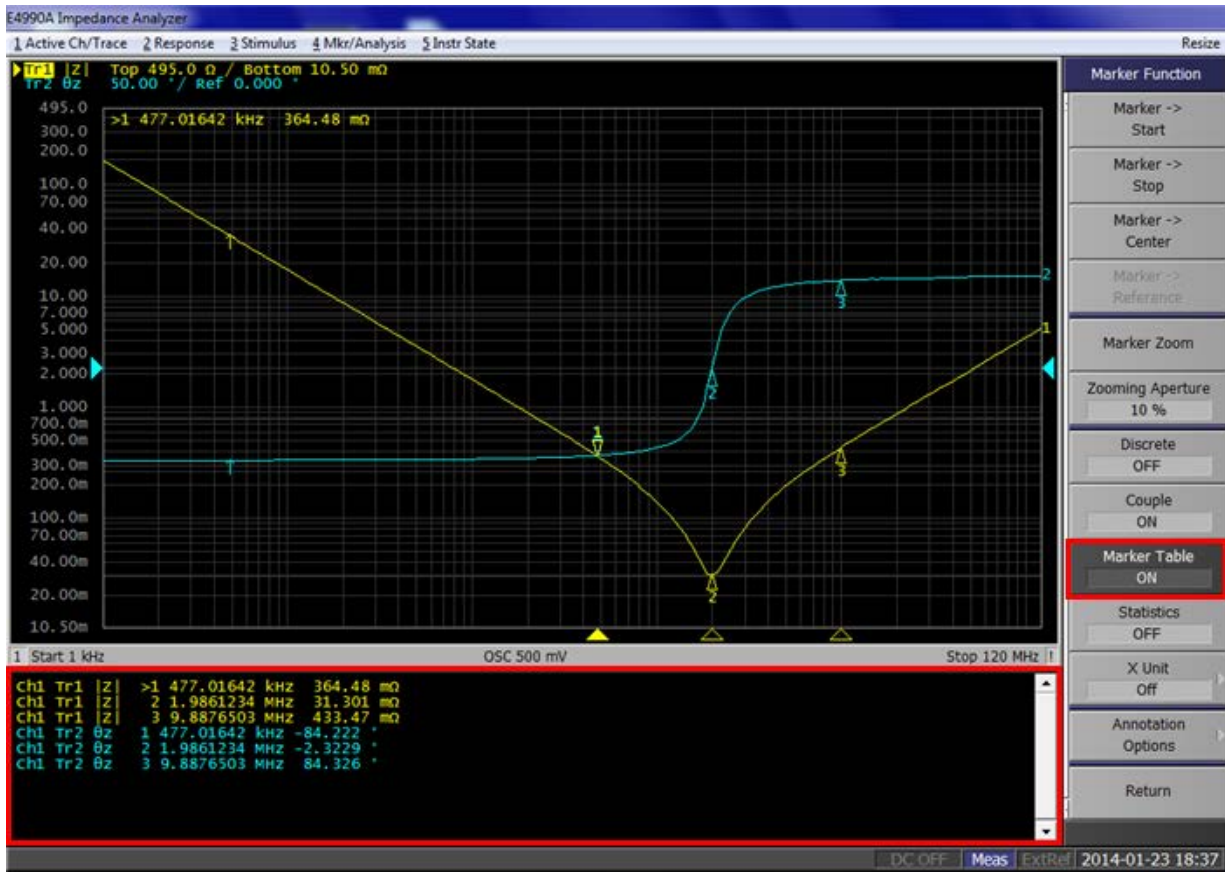

e4990a066

Specifying Display Position of Marker Values

This section describes how to specify the marker value display position for each active trace.

E4990A Impedance Analyzer Help

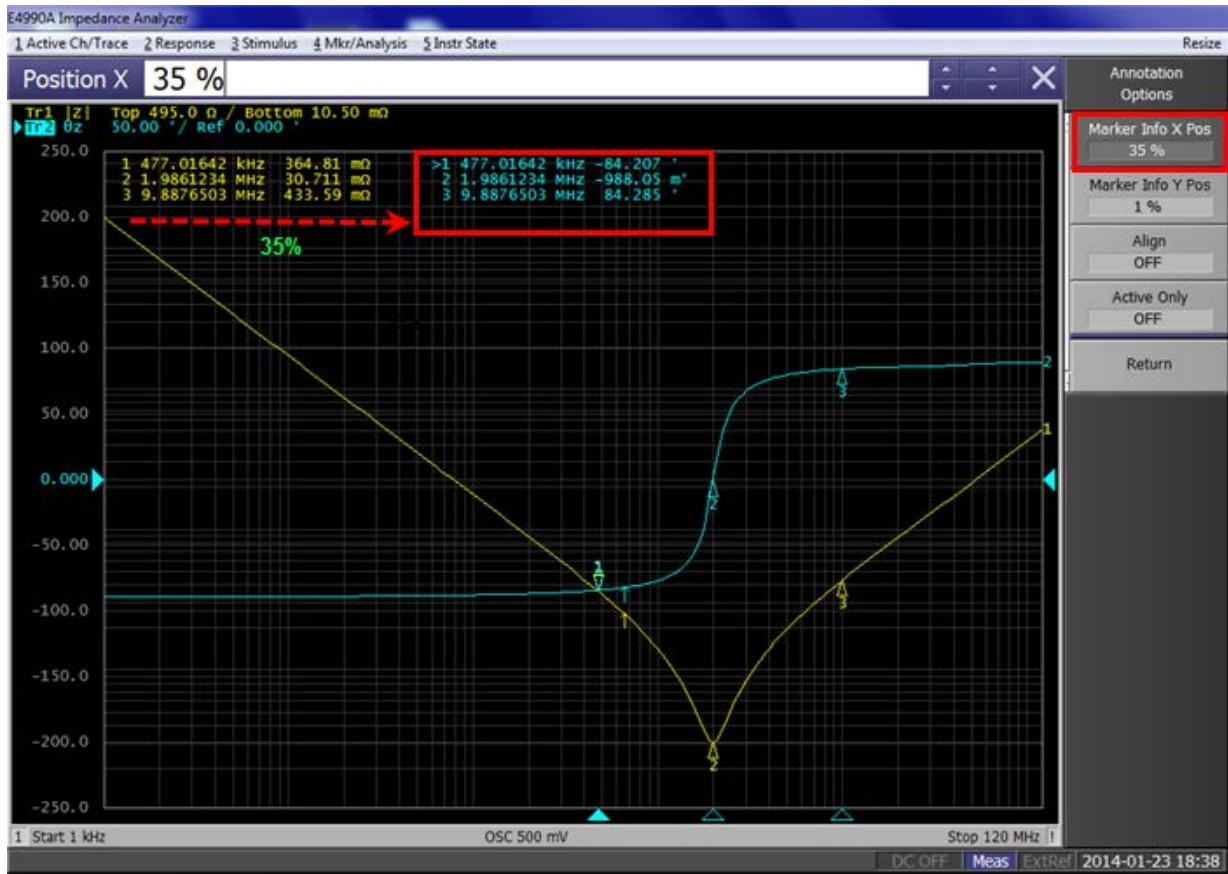

e4990a067

Value	Description
Marker Info X Pos	Specifies the horizontal display position by the width of the display area as a percentage.
Marker Info Y Pos	Specifies the vertical display position by the height of the display area as a percentage.

Operational procedure

1. Press **Channel Next** (or **Channel Prev**) to activate the channel for which you want to set the marker coupling.
2. Press **Marker Fctn** > **Annotation Options**.
3. Click **Marker Info X Pos** to set the horizontal display position.
4. Click **Marker Info Y Pos** to set the vertical display position.

Aligning Marker Value Display

This section describes how to align marker value displays.

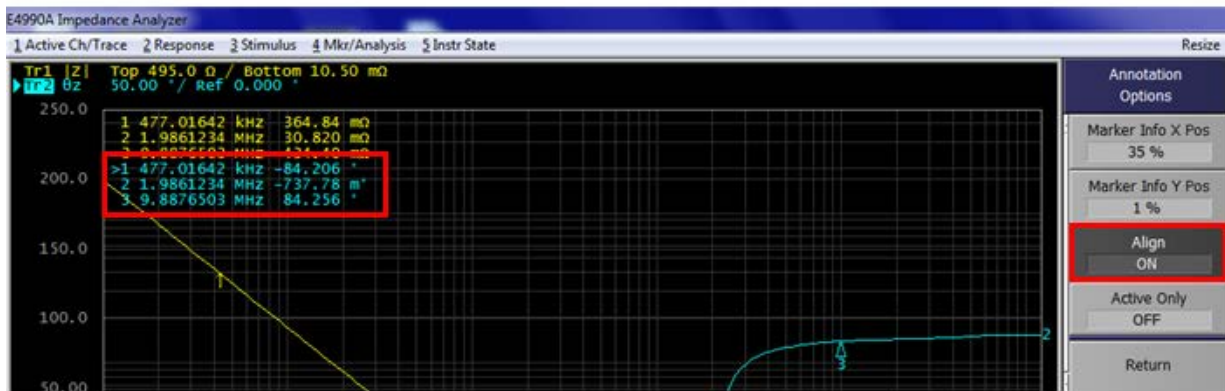
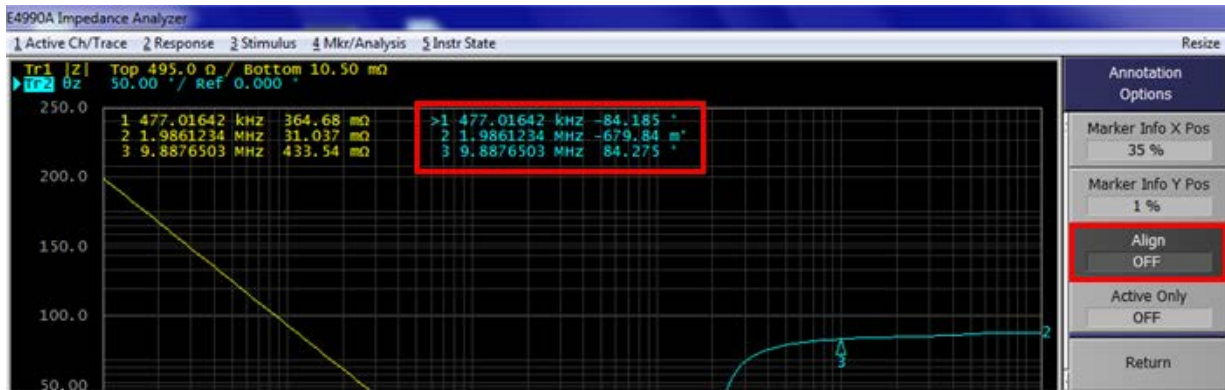

e4990a068

Value	Description
On (Align ON)	Displays marker values to align to the display position of trace 1.
Off (Align OFF)	Displays marker values in the display position defined for each trace.

1. Press **Marker Fctn** > **Annotation Options**.
2. Click **Align** to toggle ON/OFF.

Displaying All Marker Values for Displayed Traces

This section describes how to display all marker values for the displayed traces.

E4990A Impedance Analyzer Help

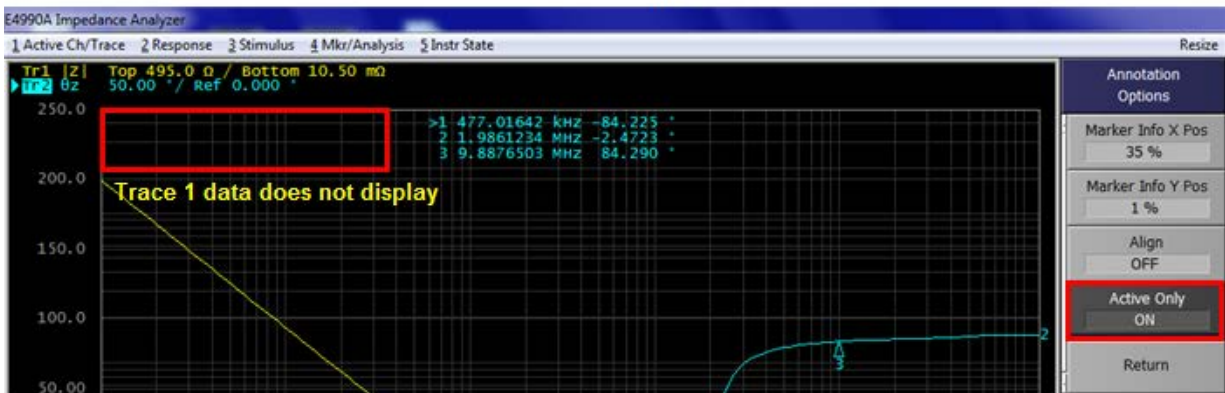
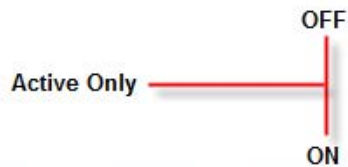
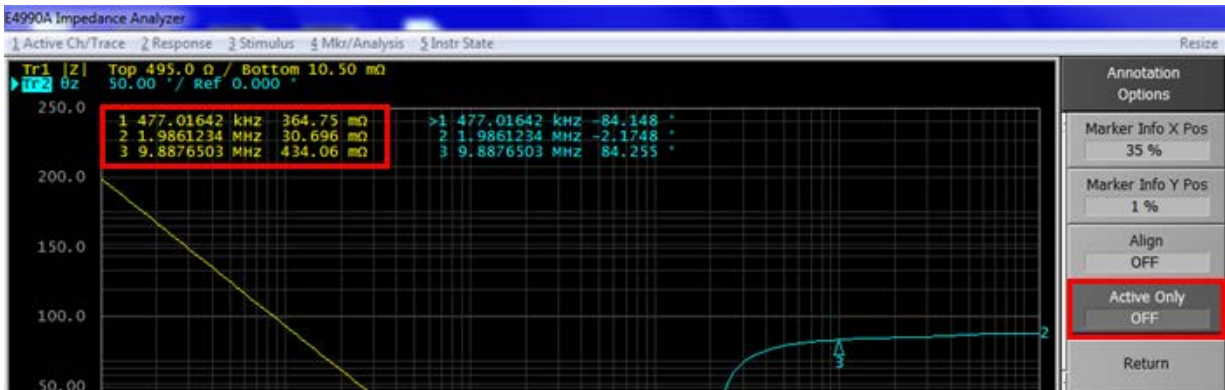

e4990a069

Value	Description
Display all (Active Only OFF)	Displays all marker values for displayed traces.
Display active markers (Active Only ON)	Displays markers for the active trace only.

1. Press **Marker Fctn** > **Annotation Options**.
2. Click **Active Only** to toggle ON/OFF.

Searching for Positions that Match Specified Criteria

- [Overview](#)

- [Setting Search Range](#)
- [Automatically Executing a Search \(Search Tracking\)](#)
- [Searching for Maximum and Minimum Values](#)
- [Searching for the Peak](#)
- [Searching for Multiple Peaks](#)
- [Searching for the Target Value \(Target search\)](#)
- [Searching for the Multiple Target Values \(Multi-target Search\)](#)

Other topics about Analysis and Processing of Result

Overview

You can search for a position that matches your specified criteria by using the Marker Search feature. Marker Search allows you to search for a position that matches any of the following criteria.

- [Maximum value](#)
- [Minimum value](#)
- [Peak](#)
 - Maximum peak (for a positive peak), minimum peak (for a negative peak)
 - Peak on the left-hand side nearest to marker position
 - Peak on the right-hand side nearest to marker position
- [Multi Peak](#)
- [Target \(a point that has a target measurement value\)](#)
 - Target nearest to the marker position
 - Target on the left-hand side nearest to marker position
 - Target on the right-hand side nearest to marker position
- [Multi Target](#)

Setting Search Range

The Marker Search feature allows you to set part of the sweep range as the search target (Partial Search feature) as well as the entire search range. For the Partial Search feature, you can select whether to couple traces in the channel.

Procedure to Turn ON/OFF Trace Coupling within Search Range

1. Press **Channel Next** (or **Channel Prev**) and **Trace Next** (or **Trace Prev**) to activate the trace for which you want to set the search range.
2. Press **Marker Search** > **Search Range**.

3. Click **Couple** to toggle ON/OFF trace coupling within the search range.

Procedure to Set Search Range

1. Press **Channel Next** (or **Channel Prev**) and **Trace Next** (or **Trace Prev**) to activate the trace for which you want to set the search range.
2. Press **Marker Search** > **Search Range**.
3. Click **Search Range** to turn ON the Partial Search feature.
4. Click **Start**, then enter the start value (lower limit) of the search range.
5. Click **Stop**, then enter the stop value (upper limit) of the search range.

Automatically Executing a Search (Search Tracking)

Search tracking is a function that sets a search to be repeated every time a sweep is done even if the execution key for the search (maximum, minimum, peak, and target) is not pressed. This function facilitates observation of measurement results such as the maximum value of traces (e.g., the insertion loss of a band pass filter).

Performing Search Tracking

1. Press **Channel Next** (or **Channel Prev**) and **Trace Next** (or **Trace Prev**) to activate the trace on which you want to set up the search tracking.
2. Press **Marker Search** key.
3. Click **Tracking** and turn the search tracking function ON/OFF.

Searching for Maximum and Minimum Values

You can search for the maximum or minimum measured value on the trace and move a marker to that point.

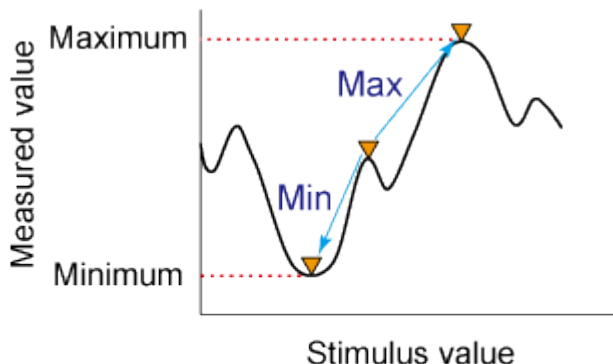

e5071c386

Search for	Move active marker to point on the trace where
------------	--

maximum (Max)	measured value is the greatest.
Search for minimum (Min)	Move active marker to point on the trace where measured value is the lowest.

Procedure

1. [Activate the marker](#) you are using to search for the maximum and minimum values.
2. Press **Marker Search** key.
3. Click the corresponding softkey to move the marker to the maximum or minimum measured value.

Searching for the Peak

The peak search function enables you to move the marker to the peak on the trace.

Definition of the peak

A peak is a measurement point of which the value is greater or smaller than the adjoining measurement points on its right and left sides. Peaks are classified into the following two types depending on the differences in magnitude from the measurement points on either side of it.

Positive peak (Positive)	A peak of which the measured value is greater than the measurement points on either side of it (peak polarity: positive).
Negative peak (Negative)	A peak of which the measured value is smaller than the measurement points on either side of it (peak polarity: negative).

About Peak Excursion Value

The peak excursion value is smaller among the differences in the measured values from the adjoining peaks of the opposite polarity.

Executing a Peak Search

The following three methods are available for executing the peak search:

Peak search (Search Peak)	Moves the marker to the maximum peak when peak polarity is Positive or Both . Moves the marker to the minimum peak when peak polarity is Negative .
Left search	Executes the search from current marker position to

(Search Left)	the smaller stimulus values and moves the marker to first peak encountered.
Right search (Search Right)	Execute the search from current marker position to the larger stimulus values and moves the marker to first peak encountered.

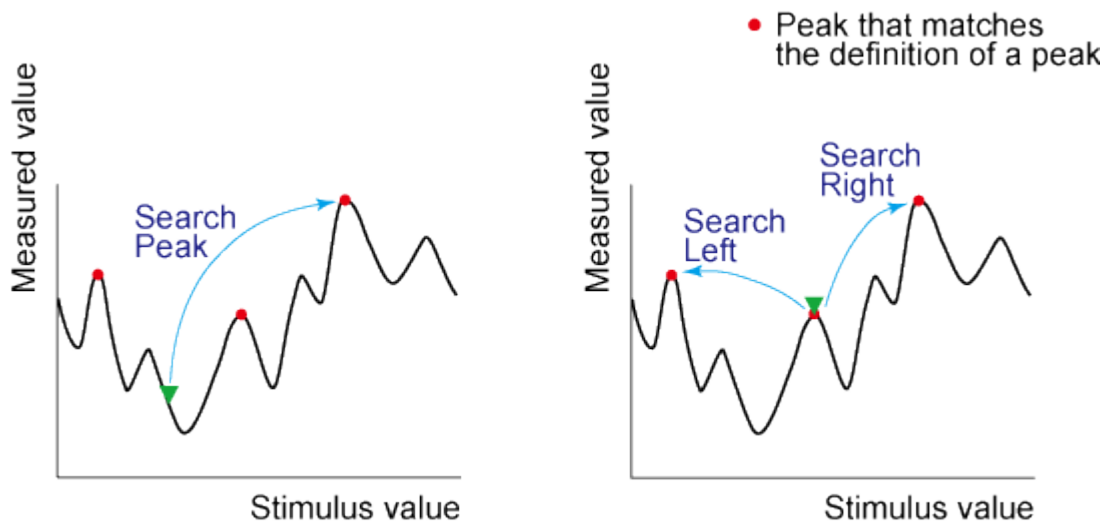

e5071c452

Procedure

1. [Activate the marker](#) you are using for the peak search.
2. Press **Marker Search** key.
3. Click **Peak > Peak Excursion**.
4. Enter the lower limit for the peak excursion value. This sets the peak search to be executed based on the definitions of the newly set lower limit for the peak excursion value and the currently set peak polarity.
5. Click Peak Polarity.
6. Select a peak polarity. This sets the peak search to be executed based on the definitions of the currently set lower limit for the peak excursion value and the newly set peak polarity.
7. Click the corresponding softkey to move the marker to the peak.

NOTE

When the data format is in Smith chart or polar format, execute the search for the main response value of the two marker response values.

Searching for Multiple Peaks

The multi-peak search function enables you to display markers on multiple peaks on traces.

Definition of the Peaks

A peak is a measurement point whose value is greater or smaller than the adjoining measurement points on its right and left sides. Peaks are classified into the following types depending on the difference in magnitude from the measurement points on either side of it.

Positive peak (Positive)	A peak of which the measurement value is greater than the measurement points on either side of it (peak polarity: positive).
Negative peak (Negative)	A peak of which measurement value is smaller than the measurement points on either side of it (peak polarity: negative).

About the Multi-peak Search Function (Search Multi Peak)

The multi-peak search is a function that searches for peaks that match with pre-defined lower limit for the peak excursion value and peak polarity (positive or negative) and then displays the markers on the peaks being searched. Depending on number of detected peaks, markers 1 through 9 are displayed from the start frequency.

The peak excursion is the smaller of the differences in measurement values from the adjoining peaks of the opposite polarity.

NOTE

When the multi-peak search is executed, search and tracking settings for markers 1 through 9 are ignored and the settings for the multi-peak search are used. Note that the reference marker is not affected.

Positive Peak/Negative Peak and Peak Excursion

Multi-peak Search (when peak polarity is positive)

Executing a Multi-peak Search

1. [Activate the marker](#) you are using for the multi-peak search.
2. Press **Marker Search** > **Multi Peak** > **Peak Excursion**
3. Enter the lower limit for the peak excursion value.

This causes the multi-peak search to be executed based on the definitions of the newly set lower limit for the peak excursion value and currently set peak polarity.

4. Press **Peak Polarity**.
5. Select a peak polarity from **positive**, **negative** or **both**.

This causes the multi-peak search to be executed based on the definitions of the currently set lower limit for the peak excursion value and newly set peak polarity.

6. Press **Search Multipeak** to move the marker to the peak.

NOTE

When the data format is Smith chart or polar format, execute the search for the main response value of the two marker response values.

Searching for the Target Value (Target search)

The target search is a function that searches for a target that matches the pre-defined target value and transition type(s) (positive, negative, or both positive and negative) and then moves the marker to that target.

Target and Transition Types

A target is a point that has a specific measured value on the trace. Targets can be divided into the two groups shown below depending on their transition type.

Transition type: Positive (Positive)	When the value of the target is larger than the measured value that immediately precedes it (on the left side).
Transition type: Negative (Negative)	When the value of the target is smaller than the measured value that immediately precedes it (on the left side).

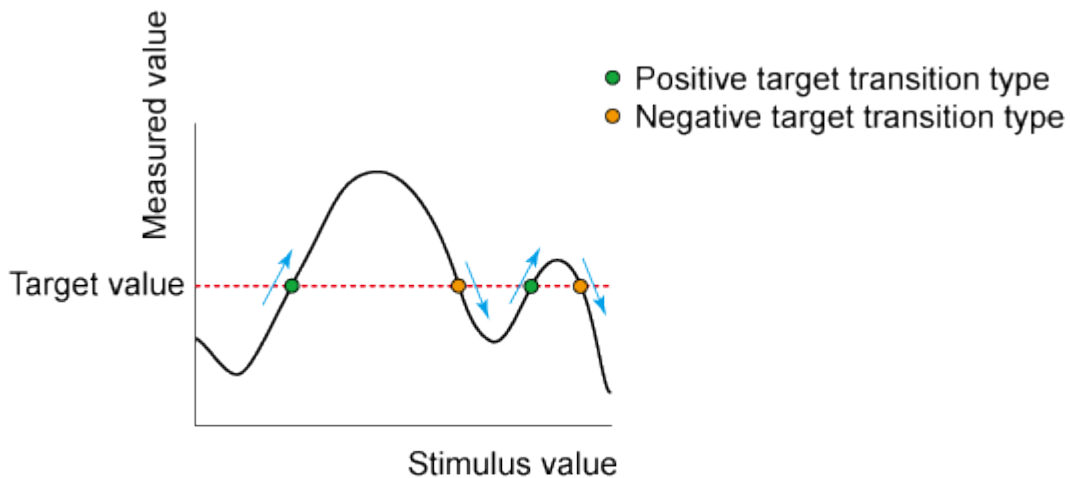

e5071c389

Executing a Target Search

The following three methods are available for executing the target search:

Target search (Search Peak)	The marker moves to the peak with maximum response value if the peak polarity is Positive or Both or to the peak with minimum response value if the peak polarity is Negative .
Search left (Search Left)	Executes the search from the current marker position to the smaller stimulus values and moves the marker to first encountered target.
Search right (Search Right)	Executes the search from the current marker position to the larger stimulus values and moves the marker to first encountered target.

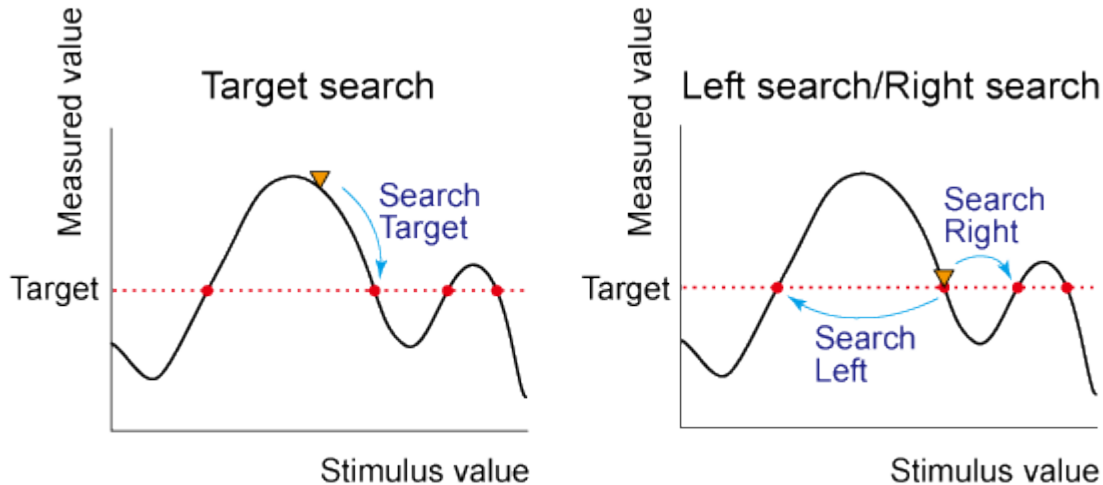

e5071c387

Procedure

1. [Activate the marker](#) you are using for the target search.
2. Press **Marker Search** key.
3. Click **Target** > **Target Value**.
4. Enter the target value in the entry area that appears. This causes the target search to be executed based on the definitions of the newly set target value and the currently set transition type.
5. Click **Target Transition**.

6. Select a transition type. This sets the target search to be executed based on the definitions of the currently set target value and the newly set transition type.
7. Press the corresponding softkey to move the marker to the target.

NOTE

When the data format is in Smith chart or polar format, execute the search for the main response value of the two marker response values.

Searching for the Multiple Target Values (Multi Target Search)

The multi-target search function enables you to display a marker on each point having the target measurement value.

Target and Transition Types

A target is a point that has a specific measurement value on the trace. Targets can be divided into two groups shown below depending on their transition type.

Positive	When the value of the target is larger than the measurement value that immediately proceeds it (on the left side).
Negative	When the value of the target is smaller than the measurement value that immediately proceeds it (on the left side).

Target and Transition Types

About the multi-target search function (Search Multi Target)

The multi-target search is a function that searches for targets that match to pre-defined target value and transition type(s) (positive, negative, or both of positive and negative) and displays markers on the targets being searched.

Depending on the number of detected targets, markers 1 through 9 are displayed from the start frequency.

NOTE

When the multi-target search is executed, search and tracking settings for markers 1 through 9 are ignored and the settings for the multi-target search are used. Note that the reference marker is not affected.

Multi-target Search (when transition type is set to "both positive and negative")

Procedure

1. [Activate the marker](#) you are using for target search.

2. Press **Marker Search** > **Multi Target** > **Target Value**.
 3. Enter a target value in the entry box that appears.
This causes the target search to be executed based on the target value newly set and the transition type defined at this point.
 4. Press **Target Transition**.
 5. Selects a transition type from **positive**, **negative** or **both**.
This causes the target search to be executed based on the target value set at this point and the transition type newly set.
 6. Press **Search Multi Target** to move the marker to the target.
- NOTE** When the data format is in Smith chart or polar format, execute the search for the main response value of the two marker response values.

Analyze Trace Bandwidth

- [Definitions of Parameters in the Trace Bandwidth Analysis](#)
- [Define the Cutoff Point in Trace Bandwidth Analysis](#)
- [Implement Trace Bandwidth Analysis](#)

Other topics about Analysis and Processing of Result

The E4990A can automatically derive the parameters called bandwidth, center value, Q value, peak, ΔL , and ΔR from the measurement trace.

At the instant when the trace bandwidth analysis function is turned On and at the completion of each subsequent sweep, cutoff points are searched for on the sweep parameter value axis, starting from the main marker position at that time and advancing in both directions. When two cutoff points are detected, six parameters (bandwidth (width), center value (center), Q, peak (peak), ΔL , and ΔR) are derived from the data at those points and displayed in the Marker Statistics/Trace Bandwidth Analysis Result field on the right of the screen.

NOTE The peak (peak), one of the six parameters displayed on the screen as trace bandwidth analysis results, is the first position of the main marker itself. Therefore, before executing the trace bandwidth analysis, use the peak search function and so on to move the main marker to the peak on the trace as necessary. The cutoff points are searched for according to the definition specified by the user. The definitions of the six parameters displayed on the screen as the final results also vary depending on the delta marker mode selected at the time.

Definitions of Parameters in the Trace Bandwidth Analysis

Table below shows the definition of each parameter in the trace bandwidth analysis.

Parameter	Definition
Cutoff point	<p>Two points having the predefined measurement parameter value that are searched for and detected from the main marker position to both ends on the trace. You define the measurement parameter value of the cutoff points by selecting, assuming that the measurement parameter value of the main marker position is $MKRVAL$, $\frac{MKRVAL}{\sqrt{2}}$, $MKRVAL \times \sqrt{2}$, $\frac{MKRVAL}{2}$ or a user entered value (fixed value). At the detected cutoff points, the sub-markers numbered 2 and 3 will be placed.</p>
Bandwidth:	<p>Indicates the interval of sweep parameter values at two cutoff points. This definition does not depend on the marker mode.</p>
Center:	<p>Indicates a midpoint between the sweep parameter values at two cutoff points. It serves as a relative value with reference to the fixed marker only when the fixed marker is present.</p>
Q	<p>Indicates value Q obtained from two cutoff points (Center/Width).</p>
Peak:	<p>Indicates the measurement parameter value at the position of the main marker (marker 0). However, it indicates a relative value with reference to the fixed marker only when the fixed marker is present. When the main marker is moved to the peak by using the peak search function, that peak is displayed at this position.</p>

ΔL	Indicates the length of the sweep parameter from the sweep center value to the cutoff point on the left. However, it indicates the length of the sweep parameter from the sweep parameter value of the fixed Δ marker to the cutoff point on the left only when the fixed Δ marker is present.
ΔR	Indicates the length of the sweep parameter from the sweep center value to the cutoff point on the right. However, it indicates the length of the sweep parameter from the sweep parameter value of the fixed Δ marker to the cutoff point on the right only when the fixed Δ marker is present.

Define the Cutoff Point in Trace Bandwidth Analysis

When trace bandwidth analysis is performed, the Keysight E4990A searches for the cutoff points on both sides with respect to the sweep parameter shaft starting from the main marker position. The cutoff point used for this search is defined by the following steps:

1. Activate the trace for which you want to analyze trace bandwidth.
2. Press the **Marker Search** key to display the Marker Search menu.
3. Press **Widths Def** to display the trace bandwidth analysis definition menu.
4. Select the definition of the cutoff point in trace bandwidth analysis from the following:

Parameter	Definition of cutoff point ¹
MkrVal/sqrt(2)	$\frac{MKRVAL}{\sqrt{2}}$
MkrVal*sqrt(2)	$MKRVAL \times \sqrt{2}$
MkrVal/2	$\frac{MKRVAL}{2}$
MkrVal*2	$MKRVAL \times 2$

MkrVal-Fixed	<i>MKRVAL</i> - fixed value
MkrVal+Fixed	<i>MKRVAL</i> + fixed value
Fixed Value	Fixed value specified by numerical value

¹ *MKRVAL*: Indicates the measurement parameter value (measurement) at the position of the main marker (marker 0).

Fixed value: Indicates the absolute value of the measurement parameter if there is no Δ marker; it is a relative value with reference to the tracking Δ marker tracking (Δ marker that moves with the main marker) is present and a relative value with reference to the fixed Δ marker if the fixed marker is present.

5. Press the **BW Fixed Value**, and input the desired bandwidth value.

Implement Trace Bandwidth Analysis

The following describes the steps to implement trace bandwidth analysis:

1. Activate the trace used to implement trace bandwidth analysis.
2. Display the main marker and move it to the desired position on the trace to analyze trace bandwidth. To move the main marker to the peak of the trace, see [Search the maximum/minimum peak](#).
3. Press the **Marker Search** key to display the Marker Search menu.
4. Press **Bandwidth > ON|OFF** to turn On or Off the trace bandwidth analysis function.

NOTE Once the trace bandwidth analysis function is turned On, the bandwidth (*width*), center value (*center*), Q (*Q*), peak (*peak*), $\Delta L(\Delta L)$, and $\Delta R(\Delta R)$ are displayed in the Marker Statistics/Trace Bandwidth Analysis Result area on the top-left of the screen.

NOTE If the trace bandwidth analysis function is turned On, the straight line showing the cutoff line is displayed parallel to the sweep parameter axis.

Cutoff point re-search does not cause the main marker to move, so it does not affect the peak value. If the two cutoff points cannot be found by trace bandwidth analysis, the message *Target Value Not Found* will appear at the bottom left side of the bar of the screen. If a partial search range is specified by following [Searching for Positions that Match Specified Criteria](#), trace bandwidth analysis will be executed within that range. Even if the trace bandwidth analysis function is turned Off, the marker used for analysis will not disappear from the screen.

Reading the marker position time or relaxation time

You can use the following procedure to select how the sweep parameter value is displayed in the Marker Sweep Parameter Value field: time relative to the sweep start or relaxation time. This function allows you to read the sweep parameter value in a unit of time at each point on the trace in the zero span sweep.

1. Press the **Marker Function** key to display the Marker Function menu.
2. Press **X Unit > Off|Time|1/2πf**.
3. Select the display method of the marker sweep parameter value.

Parameter	Definition
Off	Value of the parameter selected as the sweep parameter (frequency, oscillator level, or dc bias level)
Time	Time between the sweep start and the completion of the measurement at the marker position
1/2πf	Relaxation time = $1/2\pi f$ (f: measurement frequency)

NOTE

You can select $1/2\pi f$ as the method to display the marker sweep parameter value (marker X-axis) only when the frequency is selected as the sweep parameter. When you use the Δ marker, the relative value from the Δ marker position is displayed in the Marker Sweep Parameter Value area, regardless of the selection of the marker sweep parameter value (marker X-axis) display.

Analyzing the Equivalent Circuit and Simulate the Frequency Characteristics

- [Calculate the Equivalent Circuit Parameter based on the Measurement Result](#)
- [Simulate the Frequency Characteristics based on the Equivalent Circuit Parameter](#)



[Other topics about Analysis and Processing of Result](#)

Calculate the Equivalent Circuit Parameter based on the Measurement Result

Calculate the equivalent circuit parameter based on the measurement result trace according to the followings steps:

E4990A Impedance Analyzer Help

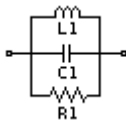
1. Measure the sample using the frequency as the sweep parameter.
2. Press **Analysis** > **Equivalent Circuit** > **Select Circuit**.
3. Select the equivalent circuit with key A, B, C, D, E, F, and G.

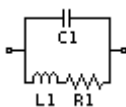
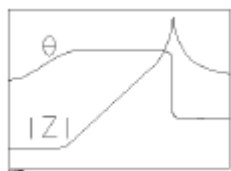
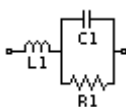
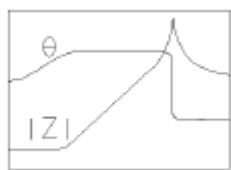
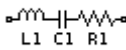
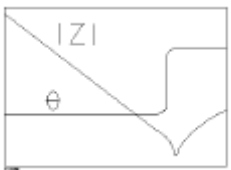
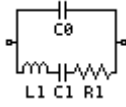
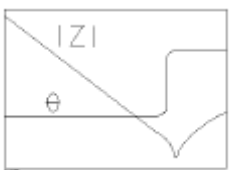
Equivalent Circuit Model	Typical Frequency Characteristics	DUT Example
<p>A</p> 	 <p>*1</p>	<p>Inductor with high core loss</p>
<p>B</p> 	 <p>*1</p>	<p>Inductor Resistor</p>
<p>C</p> 	 <p>*1</p>	<p>High-value resistor</p>
<p>D</p> 	 <p>*1</p>	<p>Capacitor</p>
<p>E</p> 	 <p>*2</p>	<p>Resonator</p>

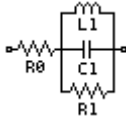
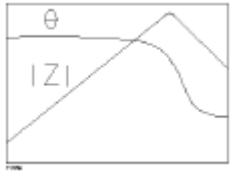
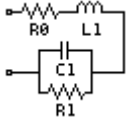
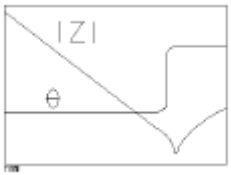
F		 <p style="text-align: right;">*1</p>	Inductor with ESR
G		 <p style="text-align: right;">*1</p>	Capacitor

*1. Measurement parameter: $|Z| - \theta$, Sweep type: log, Vertical axis: $|Z|$ is log and θ is linear.

*2. Measurement parameter: $|Z| - \theta$, Sweep type: linear (or log), Vertical axis: $|Z|$ is log and θ is linear.

- Click **Calculate** to execute calculation the equivalent circuit parameter.

The calculated equivalent circuit parameters are displayed in each box of **R1**, **C1**, **L1**, **C0** and **R0**.

Simulate the Frequency Characteristics based on the Equivalent Circuit Parameter

Simulate the frequency characteristics according to the following steps:

NOTE

Start from Step 6 when you want to simulate the frequency characteristics on the basis of the equivalent circuit parameter calculated according to the procedure of "Calculate the equivalent circuit parameter based on the measurement result".



- Measure the sample using the frequency as the sweep parameter.
- Press **Analysis** > **Equivalent Circuit** > **Select Circuit**.
- Select the equivalent circuit with key A, B, C, D, E, F, and G.
- Click **R1**, **C1**, **L1**, **C0** and **R0** to select the equivalent circuit parameter where the numerical value is to be entered.

Key Operation	Description
R1	Resistance of R1 of selected equivalent circuit.
C1	Capacitance of C1 of selected equivalent

	circuit.
L1	Inductance of L1 of selected equivalent circuit.
C0	Capacitance of C0 when the equivalent E is selected.
R0	Resistance of R0 when the equivalent F and G is selected.

The current set value of the equivalent circuit parameter is displayed in the set parameter value field of **R1**, **C1**, **L1**, **C0** and **R0**.

You can change numeric values by typing from the keyboard, keys or rotary knob of the ENTRY block on the front panel in one of the following ways to specify the parameter value.

- Enter the desired value with the numeric keys (**0** to **9**, **+/-** and **.**) and then press one of the unit keys (**G/n**, **M/ μ** , **k/m** or **x1**).
 - Turn  on the front panel until the desired value is set.
 - Press  key on the front panel to set the desired value.
5. Repeat step 1 to 4 to set all required equivalent circuit parameters.
 6. Click **Simulate (ON)**.

NOTE

The selected equivalent circuit model frequency characterization is simulated based on the equivalent circuit parameter entered or calculated by the **Calculate** button. The simulated results are stored into the memory trace and displayed on screen.

7. Click **Display (ON)** to display the equivalent circuit model in schematic and the value of each equivalent parameter on the bottom-left of the channel window.
8. Click **Export to TXT File** to save the equivalent circuit parameters in text file at user-defined location.

Calculating the Mean Value, Standard Deviation, and p-p of the Trace

- Overview
- Displaying Statistical Data

[Other topics about Analysis and Processing of Result](#)

Overview

You can easily determine the statistics data for a trace (span, mean, standard deviation, and peak-to-peak). The definitions for the statistics data elements are shown below. It is calculated within the range of markers 1 and 2. The markers 1 and 2 are activated automatically.

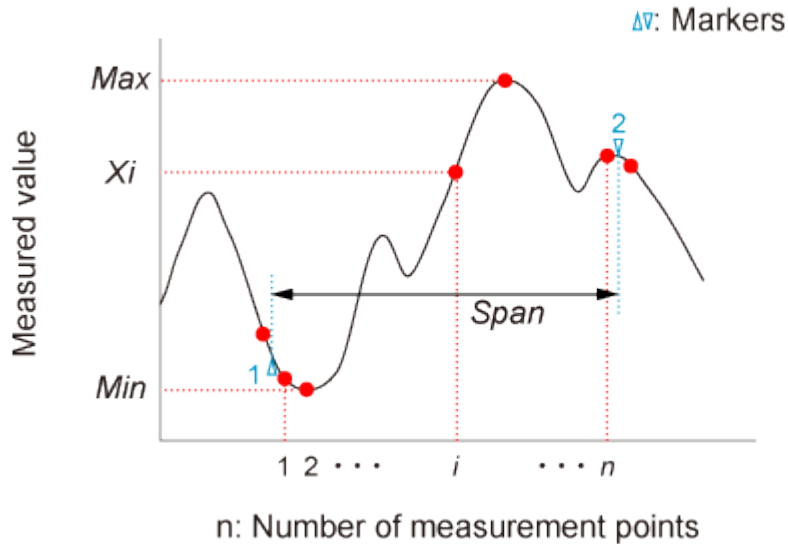

e5061b063

Statistics data element	Definition
Span	Span between markers 1 and 2.
Mean (mean)	$\frac{\sum_{i=1}^n x_i}{n}$ <p>(n: number of points between markers 1 and 2; xi: measured value at the i-th measurement point between markers 1 and 2.)</p>
Standard deviation (s. dev)	$\sqrt{\frac{\sum_{i=1}^n (x_i - mean)^2}{n-1}}$ <p>(n: number of points between markers 1 and 2; xi:</p>

	measured value at the i-th measurement point between markers 1 and 2; mean: Mean)
Peak-to-peak (p - p)	Max - Min (Max: greatest measured value between markers 1 and 2.; Min: smallest measured value between markers 1 and 2.)

NOTE

The [search range](#) does not affect this result.

Displaying Statistical Data

1. Press **Channel Next** (or **Channel Prev**) and **Trace Next** (or **Trace Prev**) to activate the trace of which the statistical data is required.
2. Press **Marker Fctn** > **Statistics** to turn ON the display of statistics data.
3. The markers 1 and 2 are activated automatically. Move markers 1 and 2 to the position of the measurement.

Calculating Several Traces (Equation Editor)

- [Overview](#)
- [Using Equation Editor](#)
- [Equation Editor Examples](#)
- [Equation History](#)
- [Functions and Constants](#)
- [Operators used in Equation Editor](#)

[Other topics about Analysis and Processing of Result](#)

Overview

Equation Editor allows you to enter an algebraic equation of standard mathematical operators and functions, referencing data that is available in the E4990A. Once a valid equation is entered and enabled, the display of the active trace is replaced with the results of the equation, and updated in real-time as new data is acquired. For equations that can be expressed with Equation Editor's supported functions, operators, and data, there is no need for off-line processing in a separate program.

For example, on entering the equation "Z=ACV/ACI" in the E4990A Equation Editor (**2c** in the Figure below), the resulting trace is computed as

each ACV data divided by ACI, that resulting trace is as same as absolute Z. For a 201 point sweep setup, the computation is repeated 201 times, once for each point.

Using Equation Editor

The step-by-step procedure of using Equation Editor is described below:

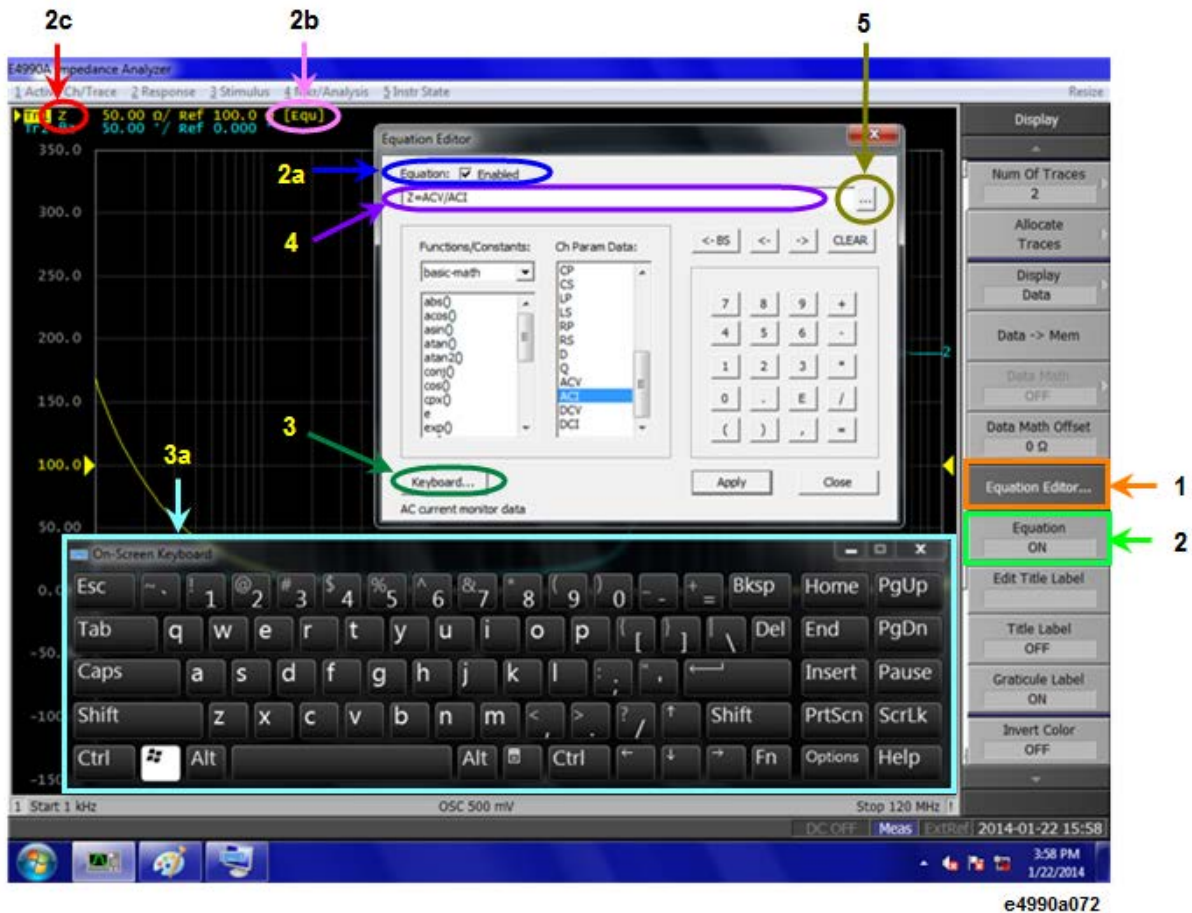

Equation Editor Dialog box

1. Select a trace in which you want to enter the equation and activate the trace.

NOTE

Activating a trace is required as Equation Editor works on traces.

2. Follow the steps below to enter an equation:
 1. Press **Display**.
 2. Click **Equation Editor** (1 in the figure above). The Equation Editor dialog box appears.
 3. Enter an equation in the equation field (4 in the figure above).

NOTE Referring to traces in a different channel is NOT available with Equation Editor on the E4990A.

NOTE The equation can be entered with the software keyboard enabled by selecting **Keyboard...** (**3** and **3a** in the figure above).

3. Follow the steps below to apply the defined equation. When a valid equation is entered, the Equation Enabled check box becomes available for checking.
 1. Check **Equation Enabled** (✓) check box (**2a** in the figure above).
 2. Click **Apply**. The equation becomes visible and annotation of [Equ] (**2b** in the figure above) is displayed in the trace title area.
 3. Click **Close** to hide the dialog box.

NOTE The equation can also be applied by selecting **Display > Equation [ON]** (**2** in the figure above).

NOTE If error correction is not turned ON, then the raw, uncorrected data is used in the equation trace.

NOTE As for E4990A, an equation is always valid.

The data trace of measured channel is always measured in E4990A. The equation might be invalid when referring to a memory trace and the memory trace isn't displayed.

Equation Editor Examples

The following examples may help you in getting started with Equation Editor. Input the equation example in the equation field (**4** in [Equation Editor dialog box](#)).

Description	Parameter	Equation Example
Add 50 Ω offset on Trace 1	Z	<i>Offset=data(1)+50</i>

See the [internal data processing](#) for equation editor data processing position.

Equation History

Equation Editor has the capability to save and recall all previously defined equations. All equations can be viewed in the Equation History dialog box.

To view the equations in the list, follow this procedure:

1. Open Equation Editor by **Display > Equation Editor**.
2. Enter an equation and click **Apply** in the [Equation Editor Dialog box](#) to save the defined equation in the directory of the E4990A. To view

a list of saved equations, click the ... button (5 in [Equation Editor Dialog box](#)) to open the Equation History dialog box.

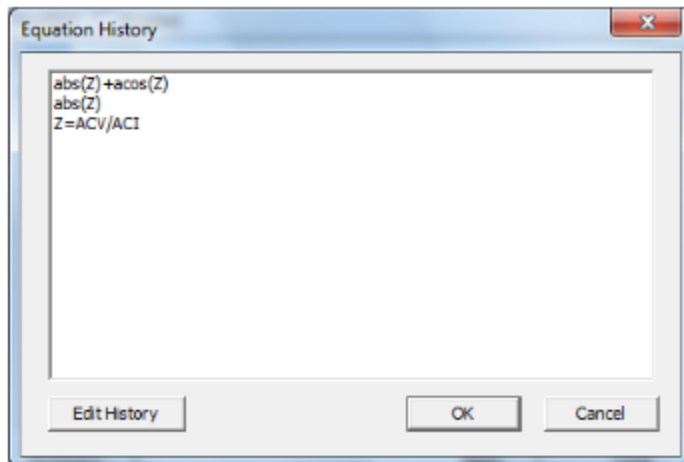

e4990a073

NOTE To store an equation in the History List, the equation must be applied first. This can be done by clicking on the **Apply** button.

3. To edit the equations in the list, click **Edit History**. The text file of **history list** is opened with Notepad.

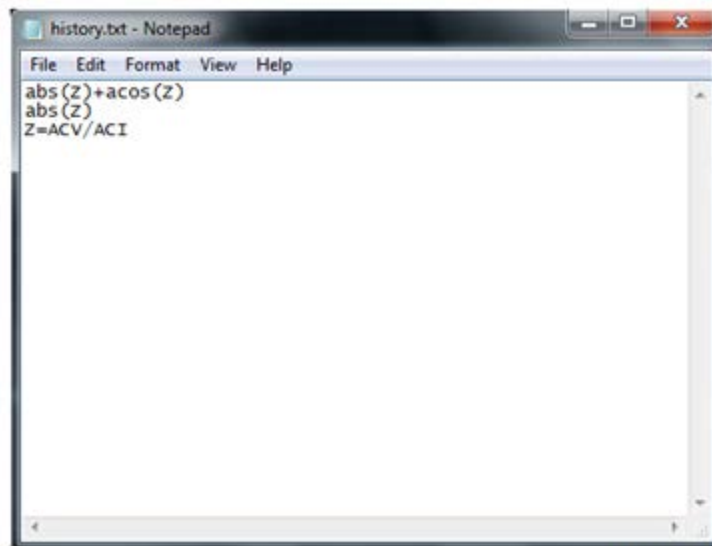

e4990a074

NOTE The **History List** is stored as a text file **D:\Agilent\Equation\history.txt** and can save a maximum of 50 lines (equations) with a maximum of 254 characters per line (equation).

Functions and Constants

The following table describes the different functions and constant available in the E4990A Equation Editor. In the following table:

E4990A Impedance Analyzer Help

- Function(*scalar x*) means that the function requires a scalar value. If a complex value is entered, it is automatically converted to a scalar value; `complex(x,y) -> scalar(x)`
- Function(*complex x*) means that the function requires a complex value. If a scalar value is entered, it is automatically converted to a complex value; `scalar(x) -> complex(x, 0)`
- **a,b** are arguments that are used in the function.

Basic Math Functions

Function	Description
<code>abs(complex a)</code>	returns the $\sqrt{a.re^2+a.im^2}$
<code>acos(scalar a)</code>	returns the arc cosine of a in radians
<code>asin(scalar a)</code>	returns the arc sine of a in radians
<code>atan(scalar a)</code>	returns the arc tangent of a in radians
<code>atan2(complex a)</code>	returns the phase of $a = (re, im)$ in radians
<code>atan2(scalar a, scalar b)</code>	returns the phase of (a, b) in radians
<code>conj(complex a)</code>	returns the conjugate of a
<code>cos(complex a)</code>	takes a in radians and returns the cosine
<code>cpx(scalar a, scalar b)</code>	returns a complex value (a+ib) from two scalar values
<code>exp(complex a)</code>	returns the exponential of a
<code>im(complex a)</code>	returns the imaginary part of a as the scalar part of the result (zeroes the imaginary part)
<code>ln(complex a)</code>	returns the natural logarithm of a
<code>log10(complex a)</code>	returns the base 10 logarithm of a

mag(complex a)	returns $\sqrt{a.re^2 + a.im^2}$
phase(complex a)	returns $\text{atan}^2(a)$ in degrees
pow(complex a , complex b)	returns a to the power b
re(complex a)	returns the scalar part of a (zeroes the imaginary part)
sin(complex a)	takes a in radians and returns the sine
sqrt(complex a)	returns the square root of a, with phase angle in the half-open interval $(-\pi/2, \pi/2)$
tan(complex a)	takes a in radians and returns the tangent
Constants	
e	2.71828182845904523536
PI	3.14159265358979323846

NOTE

Mutual transformation is automatically made for scalar and complex.

scalar(x) -> complex(x,0)

complex(x,y) -> scalar(x)

Operators used in Equation Editor

Operator	Description
+	Addition
-	Subtraction
*	Multiplication
/	Division

^	Power
(Open parenthesis
)	Close parenthesis
,	Comma - separator for arguments
=	Equal (optional)
E	Exponent (as in 23.45E6)

NOTE

Priority of operators is:

1. ^
2. *, /
3. +, -

Making Pass/Fail Evaluation (Limit Test)

- [Overview](#)
- [Concept of Limit Test](#)
- [Displaying Judgment Result of Limit Test](#)
- [Defining Limit Line](#)
- [Changing the Limit Line Display Mode](#)
- [Using Relative Limit Line](#)
- [Adding Offset to Limit Line](#)
- [Initializing the Limit Table](#)

[Other topics about Analysis and Processing of Result](#)

Overview

The limit test feature allows you to set the limit line for each trace and then perform the pass/fail judgment for the measurement result.

Concept of Limit Test

The limit test is a function to perform pass/fail judgment based on the limit line you set with the limit table.

In the limit test, if the upper limit or lower limit indicated by the limit line is not exceeded, the judgment result is pass; if it is exceeded, the judgment

result is fail for all measurement points on the trace. Measurement points in a stimulus range with no limit line are judged as pass.

NOTE

The targets of the pass/fail judgment are measurement points only. Parts interpolated between the measurement points are not judged.

You define the limit line by specifying the stimulus value (Begin Stimulus) and response value (Begin Response) of the begin point, the stimulus value (End Stimulus) and response value (End Response) of the end point, and the type (lower limit/upper limit). For more information, refer to [Defining the limit line](#).

When the limit test is ON, measurement points that fail are displayed in red on the screen and the trace's pass/fail judgment result based on the results of individual measurement points (fail if one or more measurement points on the trace fail) is also displayed. You can check the pass/fail judgment result for the channel (fail if one or more traces fail in any of the limit test within the channel) on the screen as well. For more information, refer to [Displaying judgment result of limit test](#).

In addition to viewing the screen, you can check the judgment result of the limit test with the following methods.

- Beep that occurs when the judgment result fails.
- Using the status register.

Displaying Judgment Result of Limit Test**Judgment result of measurement points and trace**

Measurement points that fail are displayed in red on the screen. The judgment result of the trace is indicated by Pass or Fail displayed in the upper right section of the graph.

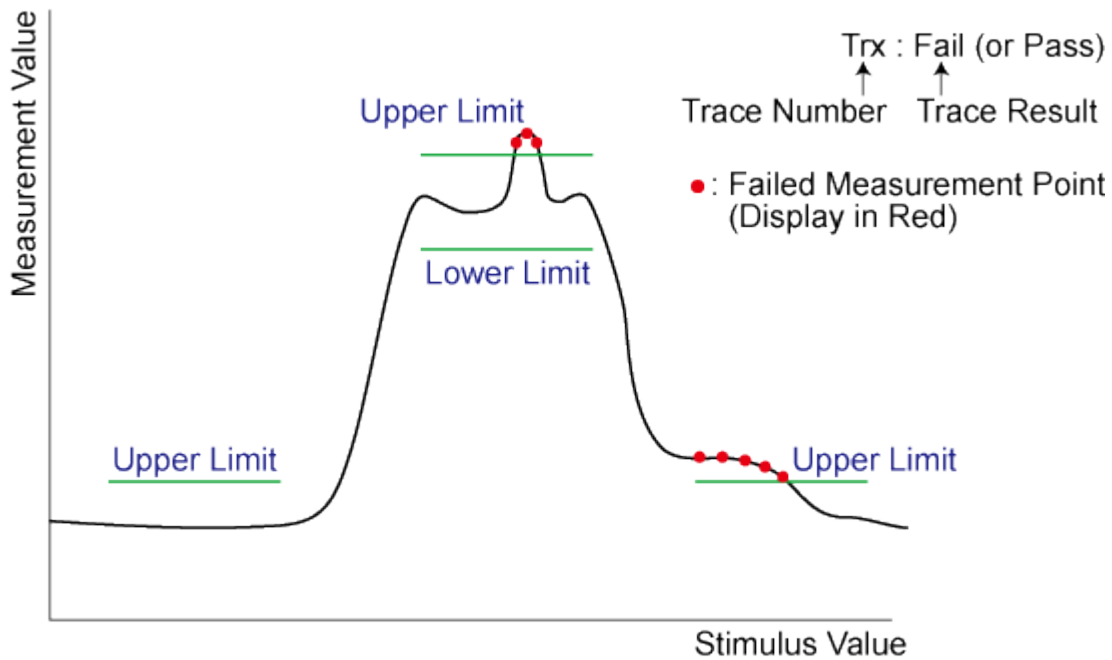

e5071c446

Judgment result of channels

If a channel has a judgment result of fail, the message below appears on the screen (it will be judged as fail if one or more unsatisfactory trace exist in any of the limit test within the channel.)



Follow these steps to turn ON/OFF the display of the channel fail message.

1. Press **Analysis** > **Limit Test**.
2. Click **Fail Sign**. Each press toggles between ON/OFF.

Defining Limit Line

To use the limit test, you must first define the limit line. You can define a limit table for each trace, and you can define up to 100 limit lines (segments) in a limit table.

Defining a segment

The following steps describe how to define a segment.

1. Press **Channel Next** (or **Channel Prev**) and **Trace Next** (or **Trace Prev**) to select the trace on which the limit test function is used.
2. Press **Analysis** > **Limit Test**.

3. Click **Edit Limit Line** to display the limit table.

Segment Number	Type of Limit Line	Beginning Point of Stimulus	End Point of Stimulus	Beginning Response	End Point of Response
	Type	Begin Stimulus	End Stimulus	Begin Response	End Response
1	MAX	3.000000000000 kHz	20.000000000000 kHz	100 Ω	15 Ω
2	MAX	500.000000000000 kHz	8.000000000000 MHz	450 m Ω	450 m Ω
3	MIN	500.000000000000 kHz	8.000000000000 MHz	25 m Ω	25 m Ω
4	MIN	20.000000000000 MHz	100.000000000000 MHz	500 m Ω	2.5 Ω
5	OFF	20.000000000000 MHz	100.000000000000 MHz	500 m Ω	2.5 Ω
6					

e4990a075

4. Using the limit table, create/edit a segment. Initially, no segments are entered in the limit table. At the same time, the Edit Limit Line menu used to create/edit the limit table is displayed.
5. Click **Add** to add a segment to the limit table and then specify the segment parameter values shown below.

Segment Parameter	Description
Type	<p>Select the type of segment from the following:</p> <p>OFF Segment not used for the limit test.</p> <p>MIN Segment at which the minimum is specified.</p> <p>MAX Segment at which the maximum is specified.</p>
Begin Stimulus	Specify starting point for stimulus value on the limit line.
End Stimulus	Specify ending point for stimulus value on the limit line.
Begin Response	Specify starting point for response value on the limit line.

End Response	Specify ending point for response value on the limit line.
---------------------	--

NOTE The range in which stimulus values can be specified is from -500 G to +500 G. When a value outside the range is entered, a suitable value within the range is specified. Once the stimulus value is specified, changing the sweep range of the E4990A does not affect the stimulus value.

NOTE The range in which response values can be specified is from -500 M to +500 M. When a value outside this range is entered, a suitable value within the range is specified. After the response value is specified, changing formats results in changing the units but not the value.

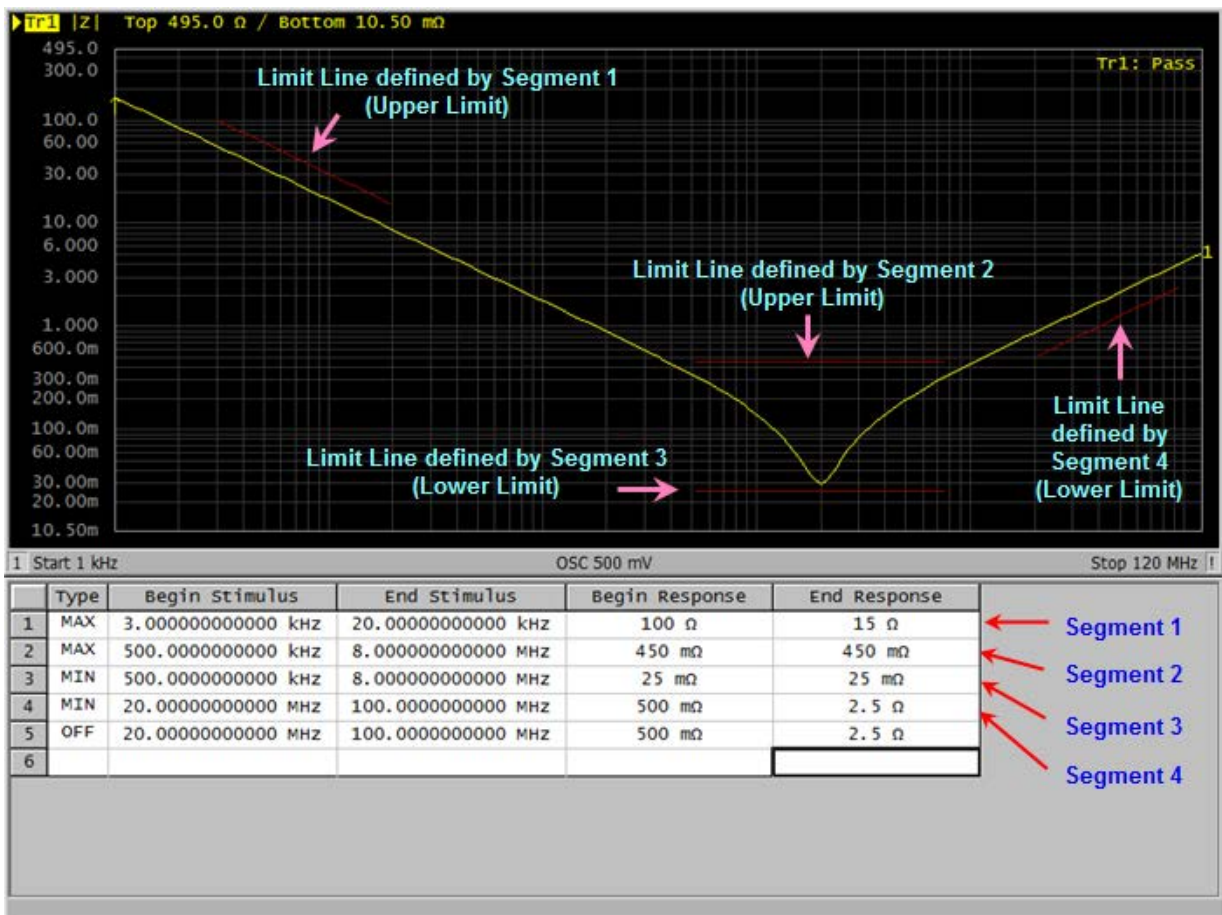

e4990a076

NOTE You can define a limit line that is able to freely overlap the stimulus range of another limit line.

Defining one limit line that has the same type as a second limit line whose stimulus range overlaps with the first one results in

two or more limit values at the same measurement point. In this case, the limit value to be used in the limit test is defined as follows:

- When two or more limit values of which the type is set to maximum (MAX) exist, the smallest one is used as the maximum.
- When two or more limit values of which the type is set to minimum (MIN) exist, the largest one is used as the minimum.

NOTE

Even if the span of the sweep range on the E4990A is set to 0, enter the two parameters of Begin Stimulus and End Stimulus.

NOTE

When two or more response values are returned as a result of using the complex or polar format, the first response value of the marker provides the object of the limit test.

Saving/Calling the Limit Table

You can save the limit table to a file that you can then freely bring up on the screen later and use. You can import a file saved in CSV format (extension: *.csv) into spreadsheet software on a PC for later use (a numerical value is saved as strings that includes its unit).

E4990A Impedance Analyzer Help

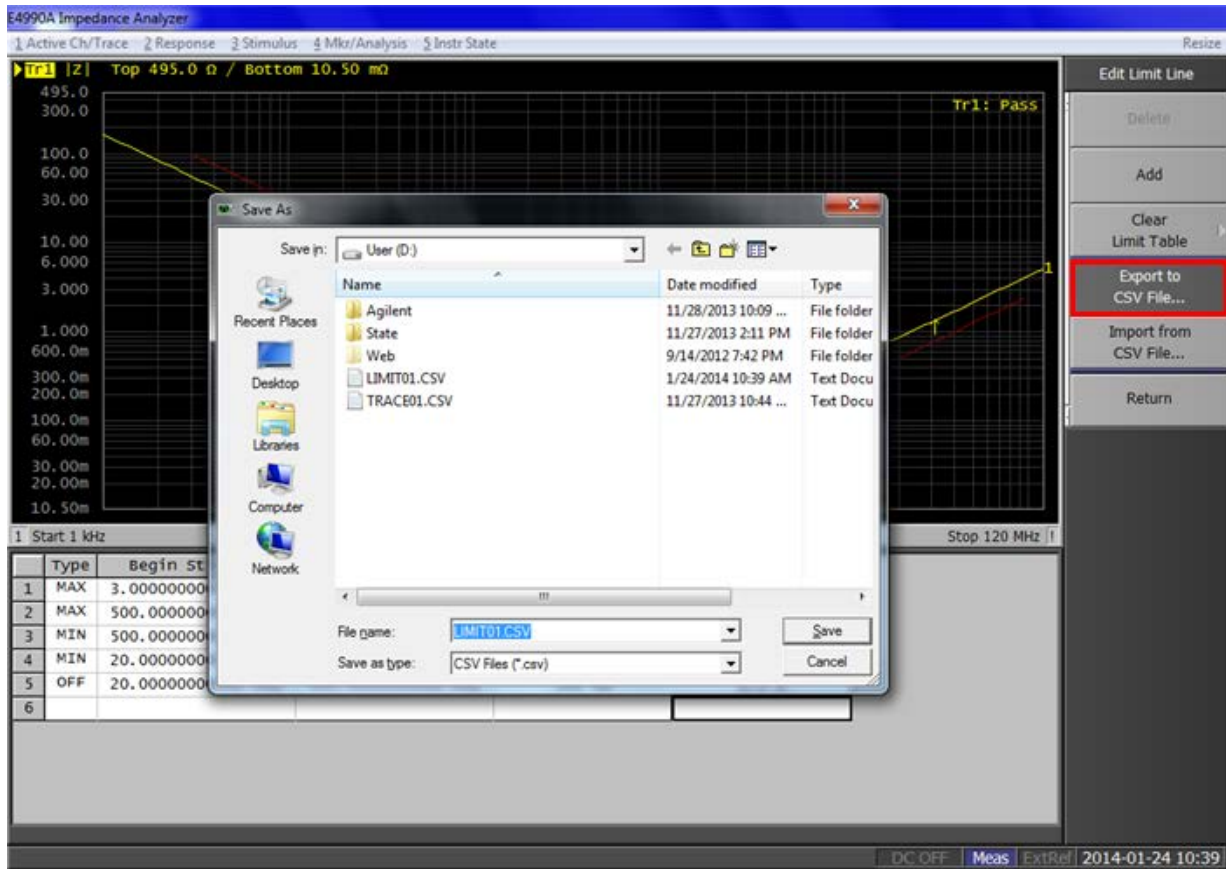

e4990a077

1. Display the limit table.
2. In the Edit Limit Line menu, press **Export to CSV File** to open the Save As dialog box. In this step, CSV (extension: *.csv) is selected as the file type.
3. Specify the folder in which to save the file and enter the file name. Press **Save** to save the limit table displayed on the screen to the file.
4. Conversely, to recall a saved limit table, press **Import from CSV File** in the Edit Limit Line menu to display the Open dialog box. In this step, CSV (extension: *.csv) is selected as the file type.
5. After specifying the folder containing the file, select the file. Press **Open** to display the limit table on the screen.

NOTE The limit table can be called from any trace of any channel, regardless of the channel or trace.

Limit Table Saved in CSV Format

The limit table is saved in the following format.

- On the first line, the channel number of the active channel that is valid when the saved file is the output.

- On the second line, the trace number of the active trace that is valid when the saved file is the output.
- The third line provides the header showing the items for the segments to be output on the fourth and later lines.
- Data on segments are output on the fourth and later lines.

"# Channel 1"

"# Trace 1"

Type,	Begin Stimulus,	End Stimulus,	Begin Response,	End Response
MAX,	3.000000000000 kHz,	20.000000000000 kHz,	100 ohm,	15 ohm
MAX,	500.000000000000 kHz,	8.000000000000 MHz,	450 mohm,	450 mohm
MIN,	500.000000000000 kHz,	8.000000000000 MHz,	25 mohm,	25 mohm
MIN,	20.000000000000 MHz,	100.000000000000 MHz,	500 mohm,	2.5 ohm
OFF,	20.000000000000 MHz,	100.000000000000 MHz,	500 mohm,	2.5 ohm

Turning the limit test ON/OFF

You can set the limit test ON/OFF for each trace individually.

1. Press **Channel Next** (or **Channel Prev**) and **Trace Next** (or **Trace Prev**) to select the trace on which the limit test function is used.
2. Press **Analysis** > **Limit Test** to display the Limit Test menu.
3. Press **Limit Test** to set the limit test ON/OFF.
4. Press **Limit Line** to set the limit line display ON/OFF.

Changing the Limit Line Display Mode

You can specify the limit line display mode hide limit values that are not used for evaluation.

Changing the display mode:

1. Press **Channel Next** (or **Channel Prev**) and **Trace Next** (or **Trace Prev**) to activate the channel of which you want to use the limit test function.
2. Press **Analysis** > **Limit Test**.
3. Turn off **Limit Line**.
4. Press **Clip Lines** to toggle ON/OFF.

Limit line display mode

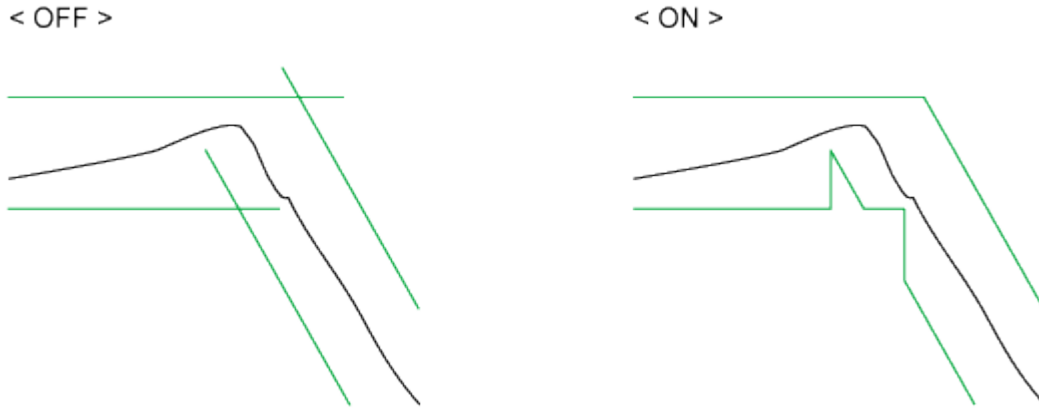

e5061b057

Using Relative Limit Line

If the shape is more important than the amplitude, you can make the limit lines relative to the peak point of the trace using the reference tracking function.

In this function, the point to be tracked is set as the Y-axis reference value by offsetting measurement values after the sweep. Because measurement values are offset, marker values and limit test evaluation results change accordingly.

1. Press **Channel Next** (or **Channel Prev**) and **Trace Next** (or **Trace Prev**) to select the channel/trace.
2. Press **Scale** > **Reference Tracking**.
3. When you want to specify a measurement value at a frequency as the Y-axis reference value for tracking, press **Track Frequency**, then enter the frequency.
4. Press **Tracking** to select a tracking method as below.

Softkey	Function
Track Peak	Sets the peak value after the sweep as the reference value.
Track Freq	Sets a measurement value at a specified frequency as the reference value.

5. **PTrk** (Track Peak) or **FTrk** (Frequency) is displayed at the [trace status area](#).

NOTE

This function is available even when the limit test function is off.

Adding Offset to Limit Line

By adding a certain offset to the limit value, you can adjust the limit line so that it conforms to the device output.

1. Press **Channel Next** (or **Channel Prev**) and **Trace Next** (or **Trace Prev**) to select the channel/trace on which the limit test function is used.
2. Press **Analysis** > **Limit Test** to display the softkeys for the limit test.
3. Click **Limit Line Offsets** to display the limit line offset function menu as below.

Softkey	Function
Stimulus Offset	Adds a certain offset to the stimulus value of the entire segment in the limit table. (Stimulus offset)
Amplitude Offset	Adds a certain offset to the response value of the entire segment in the limit table. (Amplitude offset)
Marker -> Amplitude Offset	Adds the amplitude offset by the same amount as the retrieved value of the active marker. You can confirm the current value set for the amplitude offset by pressing Amplitude Offset . (Marker amplitude offset)

Stimulus offset

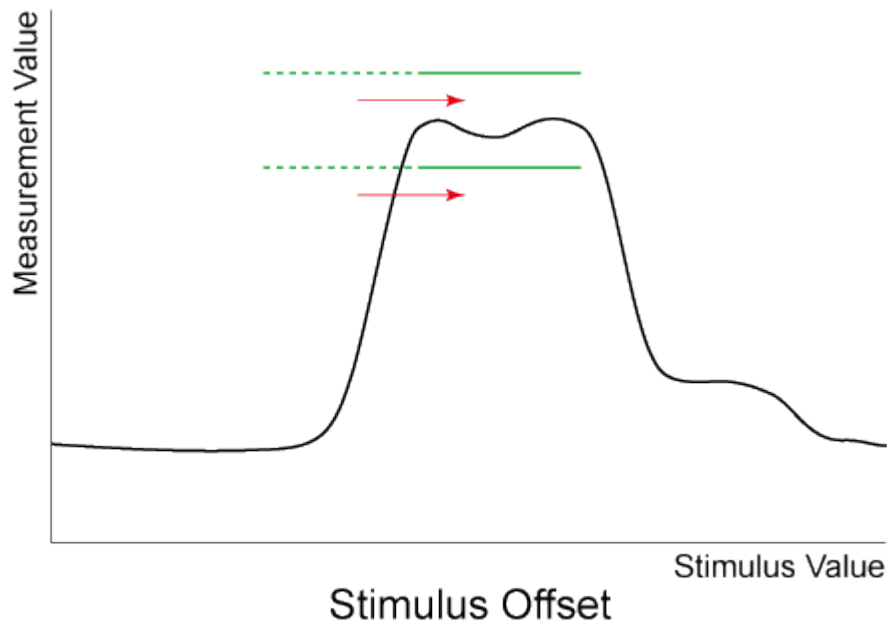

e5071c447

Amplitude offset

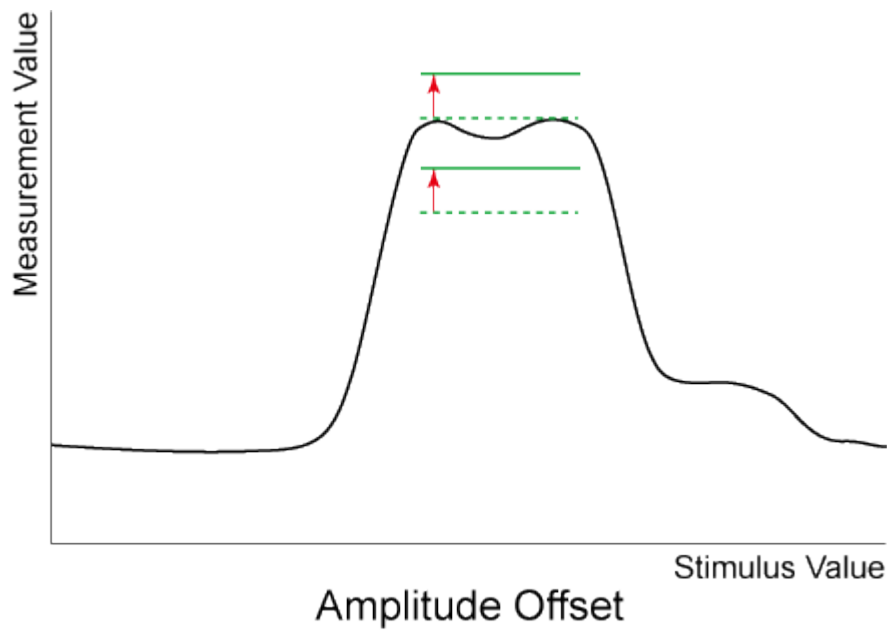

e5071c448

Initializing the Limit Table

The following operations initialize the limit table.

- At power-on
- When presetting

- When calling a limit table with zero segments
- When **Clear Limit Table** > **OK** is pressed in the Edit Limit Line menu

Outputting Data

Outputting Data

- [Saving and Recalling Instrument State](#)
- [Saving/Recalling Instrument State for Each Channel into/from Memory](#)
- [Saving Trace Data to a File](#)
- [Saving the Screen Image to a File](#)
- [Printing Displayed Screen](#)

Saving and Recalling Instrument State

- [Overview](#)
- [Saving Data](#)
- [Recalling Data](#)
- [Priority of Recalling Configuration File at Startup](#)

[Other topics about Data Output](#)

Overview

You can save the instrument state of the E4990A into a file on mass storage and then recall it later to reproduce that state. You can select the stored data from the following four types.

Type	Stored data and usage
State only (State Only)	Saves the setting of the E4990A and reproduces the state when it is saved by recalling it later into the E4990A.
State and calibration data (State & Cal)	Saves the setting of the E4990A and calibration data (calibration coefficient array) to reproduce the state when it was saved by recalling it later into the E4990A. At this time, you can perform error correction of measured values by using the recalled calibration data.

State and trace (State & Trace)	Saves the setting of the E4990A and traces (error-corrected data array and error-corrected memory array) to reproduce the state when it was saved by recalling it later into the E4990A. At this time, the traces are also recalled and displayed on the screen.
State, calibration data, and traces (All)	Saves the setting of the E4990A, calibration data, and traces to reproduce the state when it was saved by recalling it later into the E4990A. At this time, the calibration data and traces are also recalled.

In addition, the [user-preset function](#) is provided to allow the user to freely set up an instrument state recalled when the preset function is executed.

Saving Data

Selecting Content to be Saved

NOTE

This setting takes effect both, when saving the entire instrument state into a file and when saving the instrument state for each channel into memory.

1. Press **Save/Recall** > **Save Type**.
2. Click the softkey corresponding to the content of the instrument state you want to save.

Selecting Save Target Channel/Trace

1. Press **Save/Recall** key.
2. Click **Channel/Trace** and select the save target from all channels/traces (**All**) or displayed channel/traces only (**Disp Only**).

If you specify the displayed channel/traces only as the save target, you can reduce the file size. However, for channels/traces that are not displayed, you cannot recall and reproduce the instrument state separately held for each channel/trace at a later time.

Saving Instrument State

Follow the procedure below to save internal data from the E4990A.

1. Press **Save/Recall** > **Save State**.
2. Click the softkey corresponding to the destination you want to save.

Softkey	Description
State01 to State08	Saves the setting of the E4990A and reproduces the state when it is saved by recalling it later into the E4990A.

Autorec	<p>Save the instrument state as the auto recall setting. The E4990A is automatically configured with this state at the startup.</p> <p>This key saves the state into the "D:Autorec.sta".</p> <p>When Autorec.sta file is found on the D: drive at startup, the E4990A is automatically configured using the saved settings. To disable the auto recall function, delete the Autorec.sta files.</p>
UserPres	<p>Save the instrument state as user preset. The user can preset the analyzer at user saved status.</p>
File Dialog...	<p>Save the instrument state as your desired file name. You can enter a file name using the Input from the front panel buttons on the dialog box when storing a file.</p>

NOTE

If **D:\Autorec.sta** is found on the system at startup, the E4990A is automatically configured using the saved settings. When the external floppy disk drive is connected as A: drive, then if **A:\Autorec.sta** is found at startup, the E4990A is also automatically configured using the saved settings. If both files are found, **A:\Autorec.sta** is recalled. To disable the auto recall function, delete the **Autorec.sta** files.

NOTE

An asterisk (*) in the upper right of the softkey indicates that the corresponding file of the softkey already exists. If you save into the existing file, the existing file is copied as **backup.sta** and then overwritten.

Recalling Data**Recalling the Saved State**

Follow the procedure below to recall internal data from the E4990A.

NOTE

If you recall a file that includes traces (its content was set to **State & Trace** or **All** when it was saved), the trigger source is automatically set to Manual.

1. Press **Save/Recall** > **Recall State**.

When you want to recall State01.sta - State08.sta, Autorec.sta

1. Press **State01** - **State08** or **Autorec**.

When you want to recall other files

1. Press **File Dialog...** to open the Open dialog box.
2. Select the folder and the file using the external keyboard and mouse.
3. Click **Open**.

The [warning messages](#) may appear when recall fails:

NOTE

Pressing **Save/Recall** > **Explorer** executes Windows Explorer. This helps you to browse the files in the SSD of the E4990A.

Recall Procedure using " Recall by File Name"

You can use the recall feature with the **Recall by File Name** softkey for files you have named freely and save in the **D:\State** folder. This function lets you recall a file you have named freely and save by simple softkey operation, eliminating annoying operation using the Open dialog box.

NOTE

Although there is no limit to the number of files saved in a folder, only up to 50 files are displayed on the softkeys. If more than 50 files are saved in a folder, they are sorted in the order of numbers 0 to 9 and alphabetic characters A to Z and the first 50 files are displayed as softkeys.

Although there is no limit to the number of characters of a file name, only up to 16 characters are displayed on the softkey. If a file name exceeds 16 characters, the first 12 characters are displayed on the softkey and the remaining characters are omitted and replaced with "...".

NOTE

Different files may be displayed on softkeys with the same name or a saved file is not displayed on any softkey because of the above limitations.

1. Press **Save/Recall** > **Recall by File Name**.
2. Files that have been named and saved in the **D:\State** folder are displayed on softkeys. Press the key for the file you want to recall.

Priority of Recalling Configuration File at Startup

If several instrument configuration files exist at the startup of the E4990A, only one file is recalled and set at a time in the following order of priority.

If these files do not exist, the normal preset (factory preset) is executed.

Priority	Recalled file
1	Configuration file for the auto-recall function in the A drive (If external floppy disk drive is connected.)

2	Configuration file for the auto-recall function in the D drive.
3	Configuration file for the user-preset function in the D drive. Executed when the preset operation mode is User and the file (D:\UserPreset.sta) exists.

Saving/Recalling Instrument State for Each Channel into/from Memory

- [Overview](#)
- [Saving Instrument State for Each Channel](#)
- [Recalling Instrument State for Each Channel](#)
- [Deleting Saved Instrument State \(Clearing all Registers\)](#)

[Other topics about Data Output](#)

Overview

The E4990A allows you to save/recall the instrument state for each channel independently. This function allows you to save the instrument state of the active channel independently into one of the four registers (A to D, volatile memory) and to recall the instrument state from the register to restore it as the state of the currently active channel. As in the case of saving the entire state of the instrument into a file, you can select items to be saved from four kinds.

Since you can recall the instrument state for each channel that was saved with this function from a different channel than the one used to save it, this function is very useful for copying an instrument state between channels.

NOTE

Unlike when saving the entire instrument state, the instrument state for each channel is saved into volatile memory instead of a file, so if you turn off the power, the state is lost.

Saving Instrument State for Each Channel

1. Press **Channel Next** (or **Channel Prev**) to activate a channel of which the state you want to save.
2. Press **Save/Recall** > **Save Channel**.
3. Click one of **State & Cal A to D**, **Cal Only A to D** to save the (instrument state and) calibration data of the active channel to the specified register.

NOTE

For registers having saved data, the * symbol is displayed to the right of their softkey label. If you specify one of these, its content is overwritten.

Recalling Instrument State for Each Channel

1. Press **Channel Next** (or **Channel Prev**) to activate a channel of which the state you want to recall and restore.
2. Press **Save/Recall** > **Recall Channel**.
3. Click the softkey of the register in which the state you want to restore is saved. This instrument state is recalled to the active channel.

Deleting Saved Instrument State (Clearing all Registers)

1. Press **Save/Recall** > **Save Channel**.
2. Click **Clear States**. The contents of all the registers are deleted.

Saving Trace Data to a File

- [Saving Data in CSV Format](#)
- [Saving Data in Touchstone Format](#)

[Other topics about Data Output](#)

Saving Data in CSV Format

The E4990A allows the user to save data for the traces to a CSV file (file extension *.csv) and to load the data into PC application software for further processing.

Trace data are saved in the format shown below. The data includes the product information, date, channel No., title label, DCV/DCI and data/memory depending on the scope of saving trace and on/off of DCV/DCI monitors, title label, data/memory.

Example of saved trace data

```
!Agilent Technologies,E4990A,MY521012345,A.02.10
!Date: Fri Apr 03 13:41:16 2015
BEGIN CH1_DATA
Title label, TEST DATA
DCV(V), +5.230e-005, DCI(A), +2.335e-005
Frequency(Hz), |Z|(Ohm)-data, theta-z(deg)-data, theta-z(deg)-mem
+1.0000000000e+006, +1.97459864960e+002, +8.89119473020e+001, +8.89149657750e+001
+1.24500000000e+006, +2.45930241725e+002, +8.90092068003e+001, +8.90104707237e+001
+1.49000000000e+006, +2.94468803906e+002, +8.90724204521e+001, +8.90671128428e+001
+1.73500000000e+006, +3.43114640481e+002, +8.90856077998e+001, +8.90844651816e+001
...
...
```

```

+5.00000000000e+007, +3.53962757913e+003, -8.66629583657e+001, -8.67059590257e+001
END
BEGIN CH2_DATA
Frequency(Hz), Z-Real(Ohm)-data, Z-Imag(Ohm)-data, Y-Real(S)-mem, Y-Imag(S)-mem
+2.00000000000e+001, +2.57837627123e+000, +3.50938358951e-003, +3.88047360311e-001, -
5.32160235390e-004
+2.50019900000e+005, +2.73450923252e+000, +4.94146644262e+001, +1.11653358172e-003, -
2.01749505689e-002
+5.00019800000e+005, +2.98241530912e+000, +9.87264255181e+001, +3.05986100688e-004, -
1.01195548824e-002
+7.50019700000e+005, +3.31183058460e+000, +1.48052347223e+002, +1.50958410546e-004, -
6.75104168549e-003
...
...
+5.00000000000e+007, +2.07885529619e+002, -3.53316538540e+003, +1.64789873087e-005,
+2.8236933

```

Saving Trace Data

Follow the procedure below to save trace data from the E4990A.

1. Press **Channel Next** (or **Channel Prev**) and **Trace Next** (or **Trace prev**) to select the trace to be saved.
2. Press **Save/Recall** > **Save Trace Data** > **Scope** to select the target traces to save.

Softkey	Description
Single	Active trace only
Channel	All traces in the active channel
Displayed	All displayed traces in displayed channels

3. **Save Trace Data** to display the Save As dialog box.
4. Select the destination folder and input a file name.
5. Click **Save** to save the file.
6. This function is inactive when the security level is set at low/high.

Saving Data in Touchstone Format

You can also save trace data of a E4990A active channel of S-parameter to a Touchstone format file.

Touchstone file data format

You can use data in a touchstone-format file for equivalent circuit analysis and so on using a circuit simulator such as Advanced Design System (ADS). For more information on ADS, refer to the ADS's users manual.

File Structure

E4990A Impedance Analyzer Help

In the case of the E4990A, the data array is saved as S parameters of the 1-port model in a touchstone-format file. You can read out the contents of a file with your text editor because they are text data.

You can save data in "log magnitude - angle", "linear magnitude - angle", or "real number - imaginary number."

You can use data saved in Touchstone format for a circuit simulator such as Keysight Advanced Design System (ADS) on your PC (personal computer) or workstation. For more information on the ADS, refer to the operation manual that comes with the system.

Data structure in Touchstone file

Data structure of the Touchstone file consists of a header part and a data part. The contents of the file is text data, which is ready to be read with a general text editor.

The header part consists of the returned value of *IDN?, file created date, calibration state, list of all S parameters of a specified port, and format information.

The header parts of s1p are shown below.

Header of s1p

```
!Keysight Technologies,E4990A,<ID>,<FW Revision>  
!Date <Date>  
!Data:  
!Freq S11  
# Hz S FMT R 50
```

The option line starting with "#" is placed at the beginning of the file. The structure of the option line is as follows:

Parameter	Description
Hz	Indicates the frequency unit. For the E4990A, it is fixed to Hz.
S	Specifies the type of parameters in data lines. For the E4990A, "S" is specified that indicates the S parameter.
<i>FMT</i>	Specifies the format. This can be changed by the selection. RI = Real number - imaginary number MA = Linear magnitude - angle DB = Log magnitude - angle
R 50	Specifies the characteristic impedance. For the E4990A

specified is "R 50", meaning 50 .

The following figures show the data structures of files saved in Touchstone format.

1-port Touchstone file

Restrictions when saving data in Touchstone format

Data

```

Freq (1) Tab Saa. pri (1) Tab Saa. sec (1) ↵
Freq (2) Tab Saa. pri (2) Tab Saa. sec (2) ↵
      ⋮
Freq (N) Tab Saa. pri (N) Tab Saa. sec (N) ↵

```

a : Selected test port number

Freq(n) : Frequency at measurement point n [Hz]

Saa. pri(n) : Real part(RI), linear magnitude(MA) or dB(DB) of measured parameter Saa at measurement point n

Saa. sec(n) : Imaginary part(RI) or phase(MA,DB) of measured parameter Saa at measurement point n

N : Number of measurement points

Tab : Tab

↵ : Line break

e5071c346

Saving procedure

Follow the steps below to save trace data in Touchstone format.

1. Press **Channel Next** (or **Channel Prev**) and **Trace Next** (or **Trace prev**) to select the trace to be saved.
2. Press **Save/Recall** > **Save S1P** > **S1P Format**.
3. Click the softkey that corresponds to the data format you want to save.

Softkey	Function
LogMag/Angle	Select "log magnitude - angle" data format
LinMag/Angle	Select "linear magnitude - angle" data format
Real/Imaginary	Select "real - imaginary number" data format

5. Click **Save S1P**.
6. Save As dialog box opens. For its operations, use an external keyboard and mouse.
7. Specify the folder to which the file should be saved, enter a file name, and then press **Save** to save the file.

NOTE

When saving data in a sweep process, the data during sweep is saved into a Touchstone file. That is, the previous sweep data is saved as data that has not been swept; or, if sweep was not performed previously, zero data might be saved. Therefore, you should set the active channel to the HOLD state when saving data into a Touchstone file.

NOTE

This function is inactive when the security level is set at low/high.

Saving the Screen Image to a File

- [Overview](#)
- [Saving Screen Image as File](#)

[Other topics about Data Output](#)

Overview

Along with printing, the E4990A allows the user to save screen images as bitmap (.bmp) or portable network graphics (.png) files. Saved files can be loaded into PC application software for further processing.

Saving Screen Image as File

Follow the procedure below to save a screen image to a file.

1. Display the screen to be saved as a file. If you want to save the screen with a white background, set the display mode to inverted display before saving the screen. For details about display mode, see [Setting Display Colors](#).
2. Press **System** key. The screen image at the time **System** key is pressed is the image that will be saved.
3. Press **Dump Screen Image** to open the Save As dialog box.
4. Select the file type from "Portable Network Graphics (*.png)" or "24-Bit Bitmap (*.bmp)".
5. Select the destination folder and type a file name.
6. Press **Save** to save the screen image of E4990A to a file.

Printing Displayed Screen

- [Overview](#)
- [Printed/Saved Images](#)
- [Print Procedure](#)

[Other topics about Data Output](#)

Overview

By connecting a printer to the USB port of the E4990A, you can print the displayed screen of the E4990A.

Printed/Saved Images

The display image saved in the volatile memory (clipboard) is printed/saved. If no image is saved in the clipboard, the image displayed at the time of print execution is printed/saved.

Saving image to clipboard

The **System** key also has a screen capture feature. When you press **System** key, the image displayed on the screen immediately before pressing is saved in the clipboard.

NOTE

The image in the clipboard is cleared when you execute print/save.

Print Procedure

Preparation before printing

Follow these steps to prepare for printing:

1. Turn ON the printer and connect it to E4990A.
2. Turn ON the E4990A.
3. Press **System** key.
4. Press **Printer Setup**. The Printers window opens. The icons of the printers that have been connected are displayed in the window. When you connect a print for the first time, it is automatically registered and its icon is added in the window.
5. The printer with the check mark (☑) on its icon is selected as the default printer for printing. If you want to change it, select (highlight) the icon of your preferred printer in the Printers window and then click **Set as Default Printer** in the File menu.
6. Right click the printer that selected for printing and then click Printing Preferences in the menu. The Printing Preferences dialog box for the selected printer appears. Set items necessary before printing such as Page Size and then click the **OK** button.
7. Click **Close** in the File menu.

Executing print

Follow these steps to print the screen information:

1. Display the screen you want to print.
2. Press **System** key to save the currently displayed screen onto the clipboard.
3. As necessary, press **Invert Image** to toggle between [OFF] for printing in colors close to the actually displayed screen and [ON] for printing in inverse colors.

4. Click **Print** to start printing.

NOTE

If you start printing when the printer is not ready (for example, it is not turned ON) by mistake, the Printers Folder dialog box may appear. In this case, click Cancel to close the Printers Folder dialog box, prepare your printer, and then start printing again.

NOTE

When you abort the printing, click **cancel** in the Printers Folder dialog box.

Setting Control Functions

Setting Control Functions

Remote Control

- [Setting the GPIB](#)
- [Remote Control Using HTTP \(Web Browser\)](#)

Display

- [Turning off the Date/Time Display](#)
- [Turning off the LCD Screen Backlight](#)
- [Calibration of the Touch Screen](#)

Others

- [Exit/Restart E4990A Measurement Application](#)
- [Checking the Product Information](#)
- [Backing Up License Key File](#)
- [Locking the Front Keys, Keyboard, and/or Mouse \(Touch Screen\)](#)
- [Setting the Beeper \(Built-in Speaker\)](#)
- [Setting the preset function](#)

Setting the GPIB

- [Setting talker/listener GPIB address of E4990A](#)
- [Setting system controller \(USB/GPIB interface\)](#)

[Other topics about Setting Control Functions](#)

This section describes how to set the interface necessary to use the GPIB (General Purpose Interface Bus) of the E4990A.

Setting talker/listener GPIB address of E4990A

When controlling the E4990A using GPIB commands from the external controller connected to the GPIB connector, you need to set the talker/listener GPIB address of the E4990A.

Follow these steps to make this setting:

1. Press **System** > **Misc Setup** > **GPIB Setup** > **Talker/Listener Address**.
2. Enter the address using the ENTRY block keys on the front panel.

Setting system controller (USB/GPIB interface)

When controlling an external device from the E4990A, connect the USB port of the E4990A and the GPIB port of the external device through the USB/GPIB interface.

NOTE

Do not connect two or more USB/GPIB interfaces.

Follow these steps to set the USB/GPIB interface:

1. Connect the USB port of the E4990A to the USB/GPIB interface.
2. The driver installation and connection is performed automatically.

Changing the setting of the USB/GPIB interface

If you need to check/change the setting of the USB/GPIB interface after connecting the USB/GPIB interface, follow these steps:

1. Press **System** > **Misc Setup** > **GPIB Setup** > **System Controller Configuration**.
2. The Keysight Connection Expert appears. (You can also execute Keysight Connection Expert from Task bar or Start menu in Windows.)

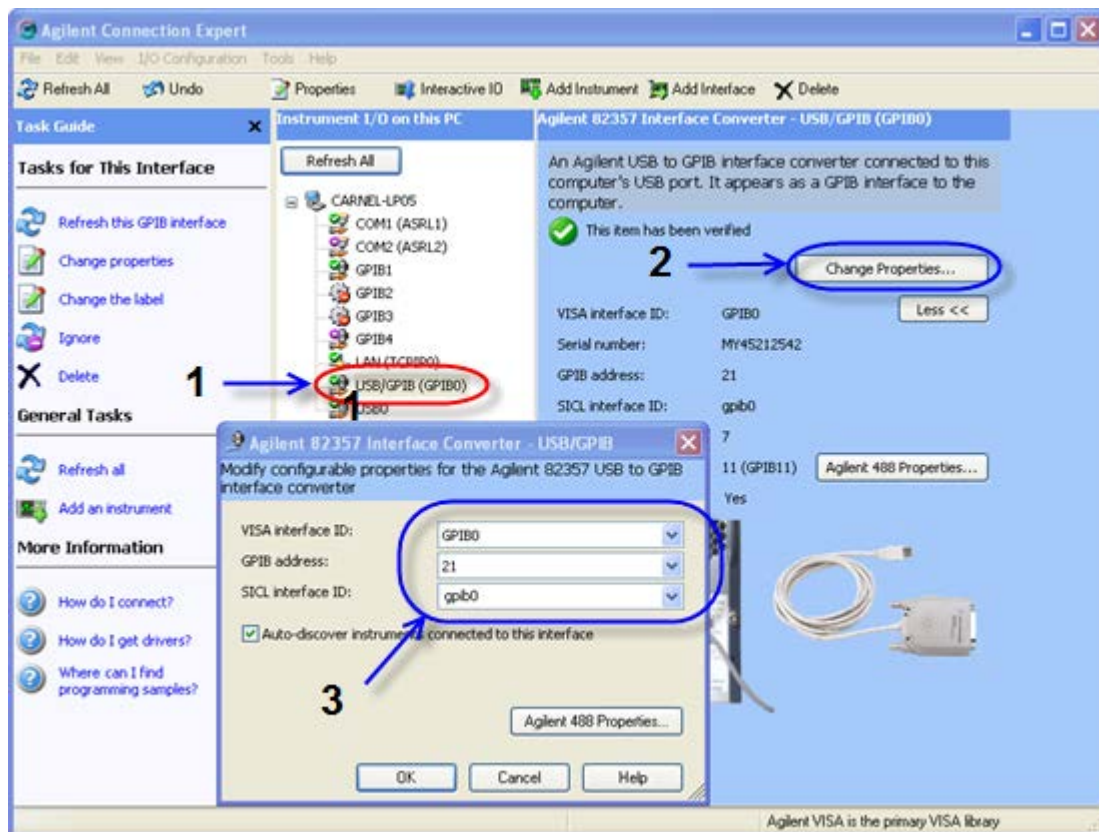

e5071c172

3. Select USB/GPIB (GPIBx)

4. Click **Change Properties....**
5. Change the setting of USB/GPIB interface.

Remote Control Using HTTP (Web Browser)

- [Enabling Web Server](#)
- [Browser Web Control](#)

[Other topics about Setting Control Functions](#)

You can access the web page installed in the E4990A by using the hypertext transfer protocol (http) and the E4990A's IP address from the external PC's web browser. This function is called web-enabled analyzer. Through the built-in web page, you can control the E4990A remotely and display the measurement screen on external PCs.

The following browsers are recommended:

- Internet Explorer 8.0 and later

Enabling Web Server

Network Configuration

To use web server, you have to configure the E4990A's network correctly. For detailed information on configuration and notes, see [Configuring the Network](#).

Enabling Web Server

Enable the web server for the E4990A so that it may allow access from an external PC. Follow these steps:

1. Press **System** > **Misc Setup** > **Network Setup** > **Enable [ON]**.
2. Press **System** > **Misc Setup** > **Network Setup** > **Mode** > **Web Server**.

NOTE

It is not possible to turn on both Web server and Socket server at the same time.

Access from an external PC

1. Execute web browser on your PC.
2. Check [IP address](#) of the E4990A.
3. Enter IP address of the E4990A in the address bar and press **Enter**.

To change LAN (TCP/IP) configuration of the E4990A

1. Click **View & Modify Configuration**.
2. Click **Modify Configuration**. Modifying this setup affects the Windows Internet Protocol (TCP/IP) property.

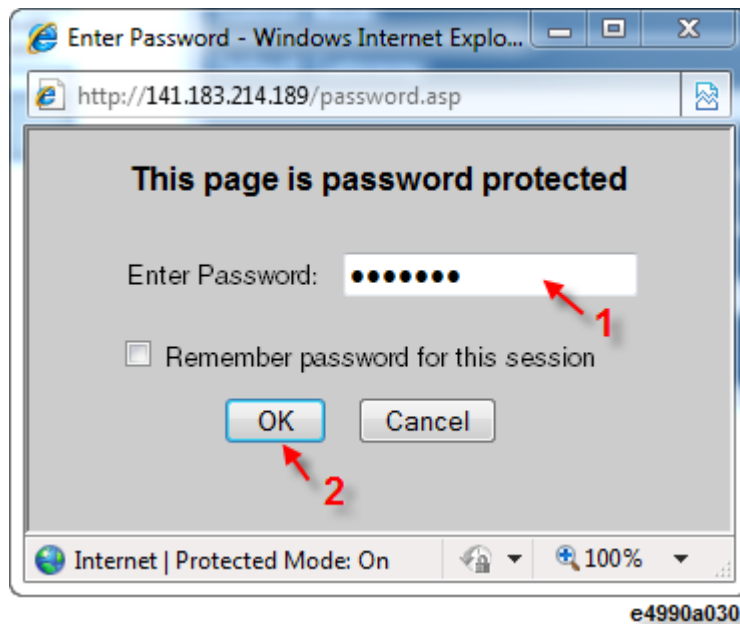

3. Enter the password (Default: "keysight") in the Password field (**1** in the figure above) and click **OK** (**2** in the figure above).

Browser Web Control

Browser Web Control function allows you to control your E4990A from web browser. This function is executed by the VNC server.

NOTE The external PC must have the Java Runtime Environment installed otherwise the Browser Web Control function might not work properly. To install Java Runtime Environment, see <http://www.java.com>.

The following is a description of how to start the VNC server configuration. Visit the web site at <http://www.realvnc.com> for information on the password setting procedure and VNC server.

1. Press **System** > **Misc Setup** > **Network Setup**.
2. Click **VNC Server Configuration** to start the VNC Server Properties.

NOTE To restrict external access, set a password for the VNC server configuration. The default password at factory shipment is blank.

NOTE Redistribution of VNC is licensed under the General Public License version 2 copyright. Source code of VNC and a copy of the GPLv2 may be found in the directory of E:\OpenSource\vnc.

Turning on/off the Date/Time Display

The date/time display in the instrument status bar can be switched ON/OFF using the following procedure.

1. Press **System** > **Misc Setup** > **Clock Setup**.
2. Click **Show Clock** to toggle the date/time display ON/OFF.

Refer to [Change Date/Time Settings](#)

[Other topics about Setting Control Functions](#)

Turning off the LCD Screen Backlight

You can switch OFF the backlight (illumination) of the LCD screen of the E4990A. This extends the life of the backlight when it is used continuously over a long period.

Turning OFF the LCD Screen Backlight

1. Press **System** > **Backlight** to switch the backlight ON/OFF.
2. Switching OFF the backlight causes the indications on the LCD screen to be almost invisible.
3. The backlight that has been switched OFF can be turned ON again by pressing any key from the front panel.

[Other topics about Setting Control Functions](#)

Calibration of the Touch Screen

When you have executed system recovery on the E4990A, you have to calibrate the touch screen. Follow the procedure described below to calibrate the touch screen.

1. Press **System** > **Service Menu** > **Test Menu** > **Adjust Touch Screen**.
2. The touch panel device properties dialog appears. Press **Calibration**.
3. The touch screen calibration screen appears.
4. Touch the x mark on the upper left with your finger. The mark x also appears on the lower left, upper right, and lower right. Touch the x marks in that order with your finger.
5. Touching all the four locations described above with your finger automatically concludes the touch screen calibration.

NOTE

With no operation on the touch screen calibration screen for a preset time, it automatically closes and the previous measurement screen reappears.

[Other topics about Setting Control Functions](#)

Exit/Restart E4990A Measurement Application

Pressing **System** > **Service Menu** > **Exit** shuts down the firmware of E4990A.

Pressing **System** > **Service Menu** > **Restart Firmware** restarts the firmware of the E4990A.

[Other topics about Setting Control Functions](#)

Checking the product information

- [Overview](#)
- [Procedure](#)

[Other topics about Setting Control Functions](#)

Overview

Items	Description	When the number changes for your unit after shipment
Serial Number	Product Serial Number. The first 5 letters expresses the prefix.	Immutable number
Storage Revision	Storage Revision. The first two letters express the prefix. The last three letters express the revision number at the factory shipment.	The prefix is immutable number. The last three letters may change by a storage replacement at repair.
Firmware Revision	Firmware revision. The format is A.xx.xx.	The number is changed at firmware update.
Option	Installed Options Number. This is managed by the license key .	The upgrade kit adds the option.
OS ID	Windows License Description	Immutable ID

IP Address	IP address when the unit is connected with LAN	It is depending on LAN configuration.
MAC Address	MAC Address of LAN interface connection.	Immutable address unless the CPU board is replaced at repair.
USB ID	USB ID for VISA connection	Immutable ID

Procedure

Follow the procedure below to get the product information.

1. Press **System** > **Firmware Revision**.
2. The Firmware Revision dialog is displayed.
3. Pressing **PC Info** shows the PC hardware information.

Activating Software Option

- [Activating Option](#)
- [Backing Up License Key File](#)

[Other topics about Setting Control Functions](#)

Activating Option

The software options can be purchased separately to enhance the E4990A measurement functionality. When you purchase the software option upgrade kit, Keysight provides the software entitlement certificate.

Procedure

1. Get the license number at <http://www.keysight.com/find/softwarelicense>.
2. Press **System** > **Service Menu** > **Enable Options**, then select option which you want to activate.
3. Type the relevant 12 character long license key sent by Keysight in Key Code entry dialog box, then click Enter.
4. [Restart the firmware](#) or reboot the instrument.
5. Check the installed option at [Product Information](#)

Backing Up License Key File

The license key for some options are kept in a text file (.lic) located at Factory(E:)\LICENSE\. The E4990A refers to the license codes in all of .lic files under the directory.

When you change the storage, copy the .lic files as back up. You can re-create the license number at

<http://www.keysight.com/find/softwarelicense> with your software entitlement certificate if the option is added with the upgrade kit.

Locking the Front Keys, Keyboard, and/or Mouse (Touch Screen)

You can lock (disable) the front keys, keyboard, and/or mouse (touch screen). This feature prevents erroneous operation caused by inadvertently touching any of these devices.

Locking the Front Keys, Keyboard, and/or Mouse

1. Press **System** > **Misc Setup** > **Key Lock**.
2. Click the corresponding key to switch the lock ON/OFF.

Softkey	Function
Front Panel & Keyboard Lock	Switches the lock of the front panel keys and keyboard ON/OFF.
Touch Screen & Mouse Lock	Switches the lock of the touch screen and mouse ON/OFF.

NOTE

You cannot use a locked device to unlock that same device. To unlock the front panel keys, keyboard, touch screen and mouse that have been locked, press the Standby switch to turn OFF the power supply and then turn it ON again. When setting at power-on, the front panel keys, keyboard, touch screen and mouse are all in unlocked condition.

[Other topics about Setting Control Functions](#)

Setting the Beeper (Built-in Speaker)

- [Setting the Operation Complete Beeper](#)
- [Setting the Warning Beeper](#)

[Other topics about Setting Control Functions](#)

The E4990A has a built-in speaker that emits a beep tone. The beeper allows you to make two types of settings.

Type	Function
Operation complete beeper	<p>Emits a beep tone to inform the user that operations have completed.</p> <ul style="list-style-type: none">• When calibration data measurements are done• When data storage has completed
Warning beeper	<p>Emits a beep tone to prompt the user to use caution.</p> <ul style="list-style-type: none">• When an instrument error occurs (An error message appears at the same time.)• When a limit test fails

The operations complete beeper emits slightly longer than the warning beeper.

Setting the Operation Complete Beeper

1. Press **System** > **Misc Setup** > **Beeper** > **Beep Complete** to switch the operation complete beeper ON/OFF.
2. Clicking **Test Beep Complete** allows you to hear and check the beep tone of the operation complete beeper.

Setting the Warning Beeper

1. Press **System** > **Misc Setup** > **Beeper** > **Beep Warning** to switch the warning beeper ON/OFF.
2. Clicking **Test Beep Warning** allows you to hear and check the beep tone of the warning beeper.

Setting the Preset Function

- [Showing/hiding the confirmation buttons when presetting](#)
- [Setting the user preset function](#)
- [Saving a user-preset instrument state](#)

[Other topics about Setting Control Functions](#)

Showing/hiding the confirmation buttons when presetting

The preset function can be executed without displaying the **OK** and **Cancel** softkey buttons when pressing the preset button of the E4990A.

1. Press **System** > **Misc Setup** > **Preset Setup**.
2. **Confirm** to toggle ON (show)/OFF (hide) the confirmation buttons.

Setting the user preset function

You can save the instrument state of the E4990A into a file in the mass storage, and then recall it with the preset function to reproduce that state.

If no user preset instrument state is stored, you cannot set the user preset function.

1. Press **System** > **Misc Setup** > **Preset Setup** > **State**.
2. Use one of the following keys for the desired setting.

Softkey	Function
Factory	Specifies the normal preset function.
User	Specifies the user-preset function .
Cancel	Returns to the softkey display in one upper level.

Saving a user-preset instrument state

To execute the user-preset function, you must have a preset setting file that has been saved. Follow these steps to save a preset instrument state of the E4990A.

1. Press **Save/Recall** > **Save State** > **User Pres**.

Using Windows

Using Windows

- [Windows Consideration](#)
- [Change Date/Time Settings](#)
- [User Account and Password](#)
- [On-Screen Keyboard](#)
- [Configuring Network](#)
- [Windows Firewall](#)
- [Enabling/Disabling USB Storage](#)
- [Connecting External Accessories](#)

Windows Consideration

- [Storage](#)
- [Using USB](#)
- [Plug & Play Stability and Security](#)
- [LAN Connections](#)
- [Single and Double Click option](#)
- [Printing](#)

[Other topics about Using Windows](#)

Storage

The E4990A storage contains several partitions. The following table explains the different partitions of the E4990A.

Drive	Description
RYxxx (C:)	The system drive is replaced with the original image when system recovery is executed. Do not change any files and folders in this.
USER (D:)	User can keep their files, in this drive. This drive is not replaced even when system recovery is executed.
Factory	This drive contains license information and back up data for

(E:)	syscal. The drive is not replaced even when system recovery is executed. Do not change any files in this.
------	---

Using USB

The E4990A has six USB ports for connecting devices: two in the front panel and four on the rear panel. The main advantages of USB are instant connect and disconnect, and faster data transfer speed.

The first time you plug a device into a USB port there is some wait time. Windows reports that it is identifying the hardware, then searching for the correct driver, then installing the driver (if it is found).

Connecting that same device back into that same port later is quick and easy, but if you move the device to a different USB port, you will have to wait through the hardware ID and driver search again.

NOTE

Some USB memory may not operate on the E4990A. In that case, try the other kind of USB memory. There are some USB memories which do not work on the front panel USB port, but work on the rear panel USB port.

NOTE

Keysight Technologies shall not be responsible for, nor assume any liability for data loss in your USB memory device after using it with the E4990A.

Plug & Play Stability and Security

Plug & Play capabilities provide both a stable and secured operating environment. You may also notice that it greatly reduces the number of required reboots.

LAN Connections

Windows supports DHCP and fixed IP addressing. Also, instant connect and disconnect of the LAN cable, as well as a visual indicator of LAN status in system tray area, makes LAN connections more intuitive. In addition, the Hardware Wizard helps users with system hardware configuration.

Single and Double Click option

By default, Windows allows a double-click method of launching icons. To revert to single-clicking, see the Windows help.

Printing

Adding a printer should be done as Windows operation. See [Connecting Printer](#).

Change Date/Time Settings

The E4990A has the built-in clock that keeps track of the date and time. This clock is used for the following functions.

- To display the current date and time in the instrument status bar at the lower part of the screen
- To write date and time information when saving internal data

Below are the options to change the **Date & Time** of E4990A:

- Double-click the clock at the bottom right of the taskbar. Click on the **Change date and time settings**. The **Date and Time** dialog box appears. Click on the **Change date and time settings** button. Perform the desired changes.
- **System** > **Misc Setup** > **Clock Setup** > **Set Date and Time....** Similar to the earlier option, the **Date and Time** dialog box appears. Click on the **Change date and time** button. Perform the desired changes.

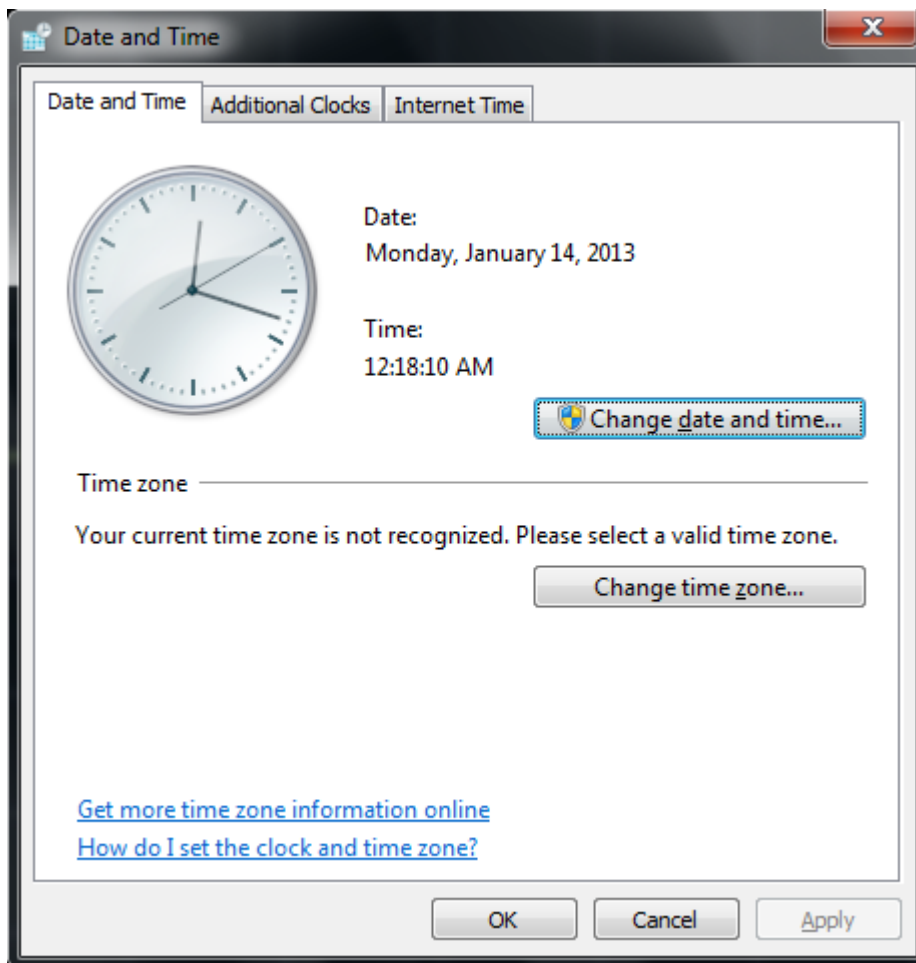

NOTE

The administrator password is required to change the time and date setting when login as standard user.

[Other topics about Using Windows](#)

User Account and Password

- [Account Settings](#)
- [To Change Password](#)
- [To Add and Remove User](#)

[Other topics about Using Windows](#)

Account Settings

The E4990A measurement application can be executed with both administrator and standard user type of account with windows.

The below account settings are available:

User Name	Password	Type	Description
Instrument	measure4u	Administrator	Auto Log On is activated by default.
Administrator	keysight4u	Built-in Administrator	For user maintenance purpose.
To be determined by user	To be determined by user	Administrator or Standard user	Not a default account setting. However, can be added by user.
Keysightonly	Not disclosed to user	Administrator	This account is used by Keysight Service in case of repair/maintenance. NOTE Do not remove this account.

NOTE

Refer to [Add and Remove User](#) to learn on how to add and remove standard user and administrator.

Standard User Limitation

The standard user account has some limitation in access, especially in performing the below tasks. These are only allowed with administrator account:

- [Change date and time settings](#)
- [Firmware update](#)
- [Enable and disable USB storage](#)
- [Enable Web Server](#)
- Saving file under specified directories (such as the root directory) determined by Windows
- Change User Account Control settings

User Account Control

With administrator account, you are allowed to modify the User Account Control settings. To access the User Account Control setting, open Control Panel, click on **User Accounts > Change User Account Control settings**. The default setting is *Notify me only when programs try to make changes to my computer*. With this selection, you are notified each time a program tries to make any changes to your computer. Other available settings are not guaranteed in the E4990A operation.

With a standard user account, default setting (*Notify me only when programs try to make changes to my computer*) should be selected before you leave from an administrator account.

To Change Password

You are allowed to change an account's password.

Change Password

1. Open **User Accounts** in Control Panel.
2. Click **Add or remove user accounts**.
3. Click on the account you would like to change password from the **Choose the account you would like to change**.
4. Click **Change the password**.
5. Enter **new password**, **confirm new password** and **password hint**.
6. Click **Change Password** button.

To Add and Remove User

Adding new user and removing existing user can be done via Control Panel.

Add New User

1. Open **User Accounts** in Control Panel.
2. Click **Add or remove user accounts**.
3. Click **Create a new account**.
4. Enter the new account name.
5. Select either **Standard user** or **Administrator**.
6. Click **Create Account** button.

NOTE The administrator authority is necessary for some of function in E4990A. Select computer administrator when you make the user account.

Remove Existing User

1. Open **User Accounts** in Control Panel.
2. Click **Add or remove user accounts**.
3. Click on the account you would like to remove from the **Choose the account you would like to change**.
4. Click **Delete the account**.

NOTE Window message confirming if you would like to keep or delete the account's files prompts.

NOTE Click either **Delete Files** or **Keep Files** button.

NOTE Next windows message prompts seeking confirmation if you are sure of deleting the selected account.

NOTE Click on **Delete Account** button.

On-Screen Keyboard

- [On-Screen Keyboard overview](#)
- [To open Windows On-Screen Keyboard](#)

[Other topics about Using Windows](#)

On-Screen Keyboard overview

On-Screen Keyboard is a utility provided by Windows that displays a virtual keyboard on the screen. It allows the users of the E4990A to input characters without the need of a keyboard.

NOTE The E4990A does not requires an external keyboard for its operation. Users can input characters using an on-screen keyboard in-built with the E4990A firmware.

On-screen keyboard in-built with the E4990A firmware

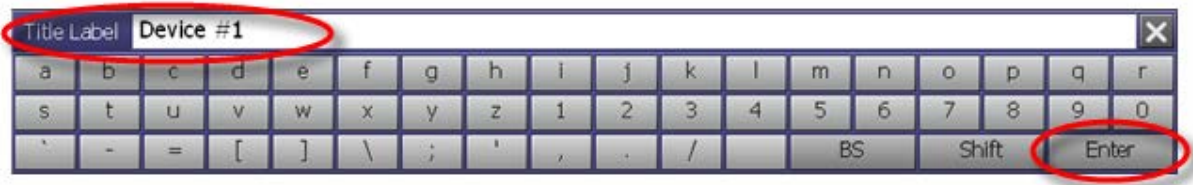

To open Windows On-Screen Keyboard

You can use Windows native on-screen keyboard as well.

To open On-Screen Keyboard: click **Start > Accessibility On-Screen Keyboard**.

On-screen keyboard provided by windows OS



e5063a098

Configuring Network

NOTE When you use the E4990A by connecting it to your LAN, consult your network administrator and make the setting of the LAN correctly.

This section describes how to set the following basic items necessary to connect the E4990A to the LAN (Local Area Network).

- [Enabling/Disabling network](#)
- [Check/Reset IP Address](#)
- [Setting IP address](#)
- [Checking computer name](#)

If you need detail network settings, consult your network administrator and perform operation in the same way as the Windows PC.

[Other topics about Using Windows](#)

Enabling/Disabling Network

You can enable/disable the network connection function of the E4990A.

To enable/disable the network connection function

1. Use the LAN cable to connect the E4990A to the LAN.
2. Press **System** > **Misc Setup** > **Network Setup** > **Network Configuration** to open **Network Connections** window.
3. Perform either of the following:
 - When switching from disable to enable:
Double-click the Local Area Connection icon in the **Network Connections** window to enable the network connection function.
 - When switching from enable to disable:
Double-click the Local Area Connection icon in the **Network Connections** window. The **Local Area Connection Status** screen appears. Click the **Disable** button to disable the network connection function.
4. Close **Network Connections** window.

Check/Reset IP Address

The IP address of the E4990A can be checked/reset by **System** > **Misc Setup** > **Network Setup** > **LAN Dialog**.

Setting IP address

Follow these steps to set the IP address:

1. Press **System** > **Misc Setup** > **Network Setup** > **Network Configuration**.
2. Double-click the Local Area Connection icon in the **Network Connections** window. The **Local Area Connection Status** screen appears.
3. Click **Properties**. The **Local Area Connection Properties** screen appears.
4. Select (highlight) **Internet Protocol (TCP/IP)**, and then click **Properties**.
5. The **Internet Protocol (TCP/IP) Properties** appears. Click (select) **Use the following IP address** and then enter the **IP address**, **subnet mask** and **gateway address**.
6. If the IP address can be obtained automatically (if the DHCP server can be used), click (select) **Obtain an IP address automatically**.
7. In **Internet Protocol (TCP/IP) Properties**, click **OK**.
8. In **Local Area Connection Properties**, click **OK**.
9. In **Local Area Connection Status**, click **Close**.
10. Close **Network Connections** window.

Checking Computer Name

Follow these steps to check the computer name:

1. Press **System** > **Misc Setup** > **Network Setup** > **Network Identification**.
2. See the desired computer name in Computer description in **Computer Name** tab.

Windows Firewall

- [To Turn Windows Firewall ON or OFF](#)

[Other topics about Using Windows](#)

To Turn Windows Firewall ON or OFF

1. Open Windows Firewall. To open Windows Firewall, open Control Panel, and then double-click **Windows Firewall**.
2. From the right column, select either **Change notification settings** or **Turn Windows Firewall on or off** option.

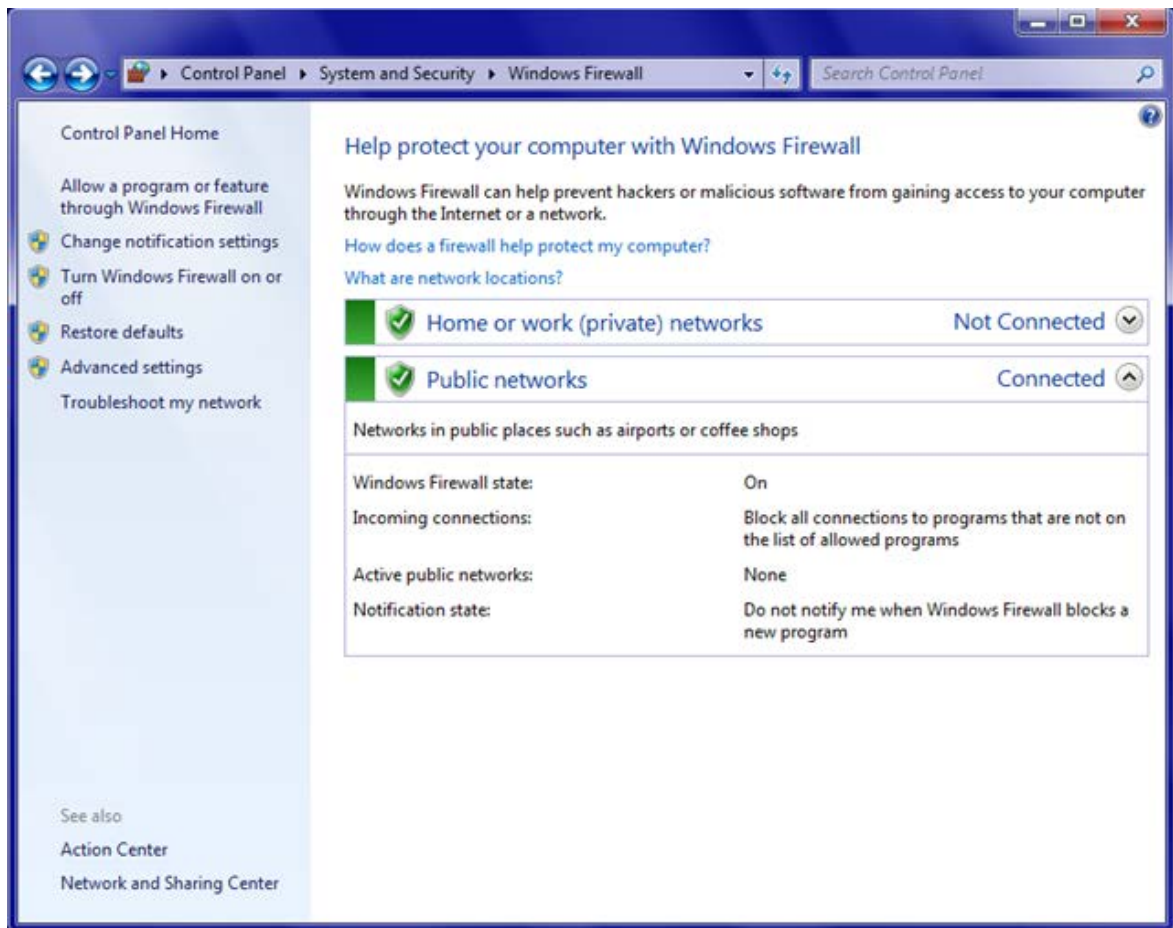

3. You may select one of the below options:

- **Turn on Windows Firewall** - this is the default and recommended option.
 - **Block all incoming connections, including those in the list of allowed programs** - this is not a preferred option.
 - **Notify me when Windows Firewall blocks new program** - this option blocks new program and notifies you, so that you can choose to block or unblock the program after reviewing it.
- **Turn off Windows Firewall (not recommended)** - this is not a recommended option. Turning OFF Windows Firewall might make your computer (and your network, if you have one) more vulnerable to damage from viruses.

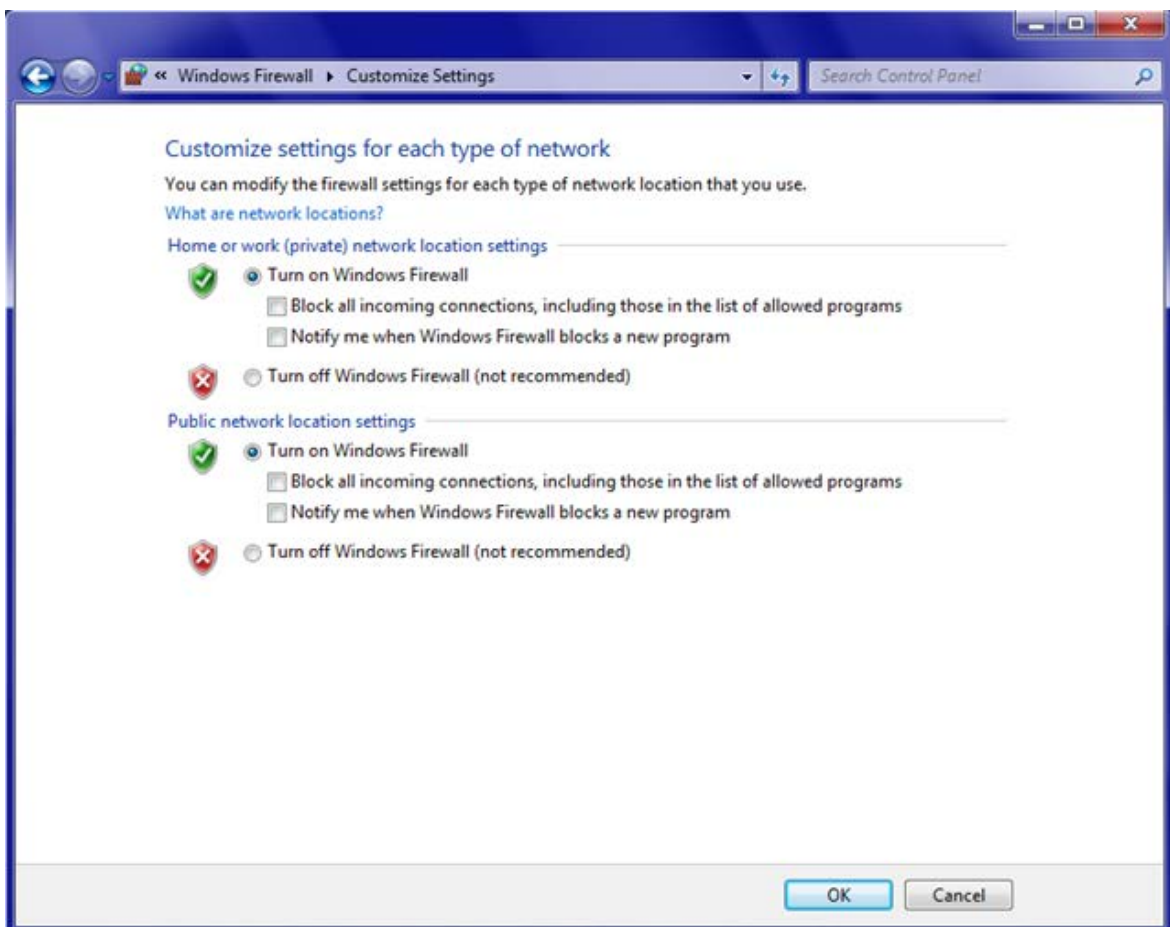

4. To restore to default settings, select **Restore defaults** from the left field in the control panel and click on the **Restore defaults** button.

Enabling/Disabling USB Storage

- [Local Group Policy Editor](#)

- [Enabling & Disabling USB Storage](#)

[Other topics about Using Windows](#)

Local Group Policy Editor

Group Policy Editor is a part of Windows operating system that allows you to control your machine. One of its feature is the ability to turn ON and OFF access to USB storage.

Group Policy Editor is a Microsoft Management Console snap-in that provides a single user interface through which all the Computer Configuration and User Configuration settings of Local Group Policy objects can be managed.

- **Computer Configuration**

Administrators can use Computer Configuration to set policies that are applied to computer, regardless of who logs on to the computers. Computer Configuration typically contains sub-items for software settings, Windows settings, and administrative templates.

- **User Configuration**

Administrators can use User Configuration to set policies that apply to users, regardless of which computer they log on to. User Configuration typically contains sub-items for software settings, Windows settings, and administrative templates.

To launch the Local Group Policy Editor:

1. Click on the **Start** menu.
2. In the **Search programs and files** entry, type [GPEDIT.MSC](#).
3. The below screen appears, with as per below

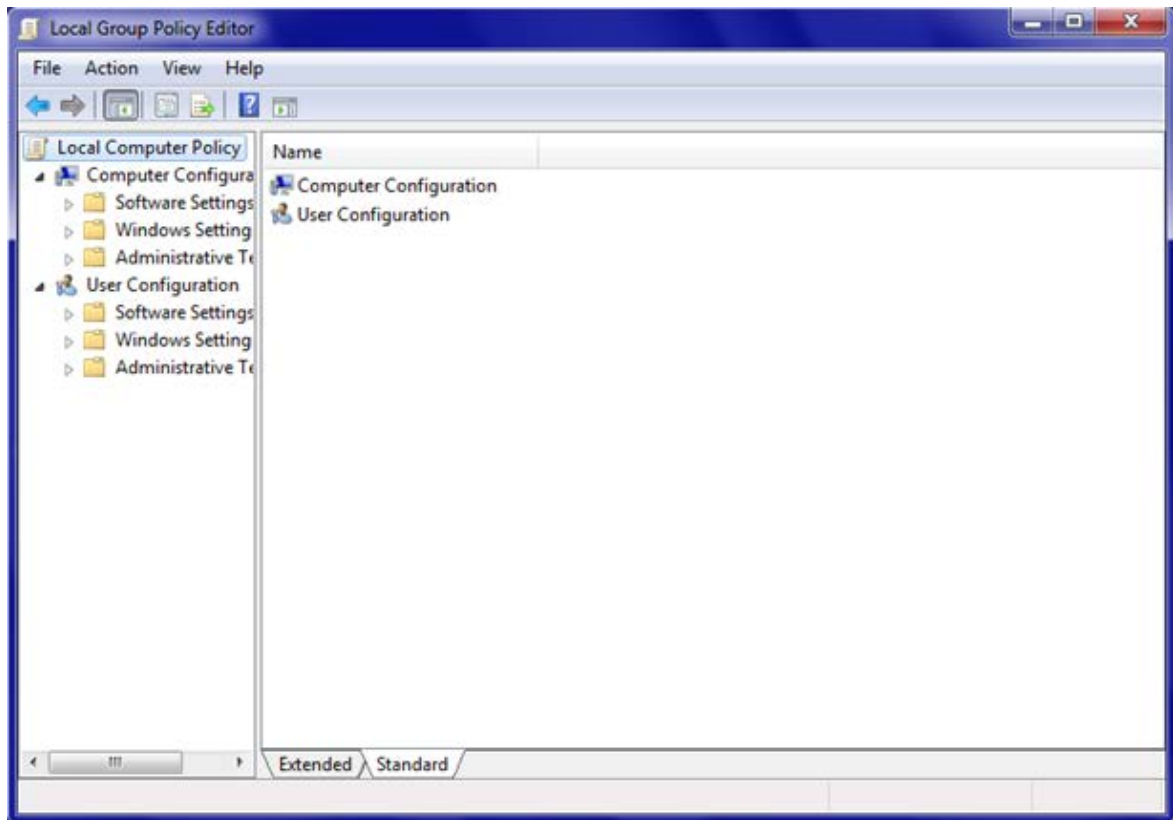

Enabling & Disabling USB Storage

1. In the left field, open **Computer Configuration > Administrative Templates > System > Removable Storage Access**.

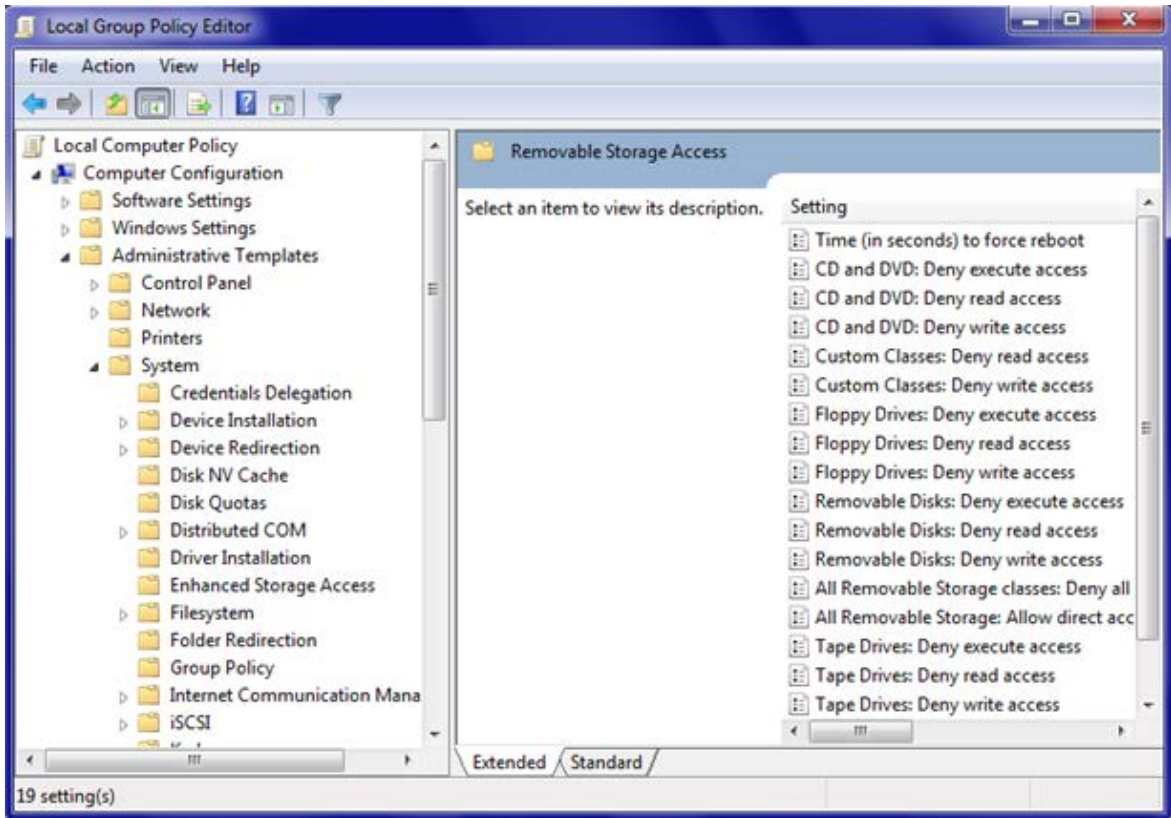

2. Table below shows the possible settings for the USB storage access:

Setting Option	Enable USB Storage (Default)	Read Only Storage	Disable USB Storage
Removable Disk: Deny execute access	Not configured	Not configured	Enable
Removable Disk: Deny read access	Not configured	Not configured	Enable
Removable Disk: Deny write access	Not configured	Enable	Enable

3. Double click on the desired setting option and the below dialog appears. As you select the desired option between Not Configured, Enabled and Disabled, the Help column at the bottom right corner displays the details of the option.

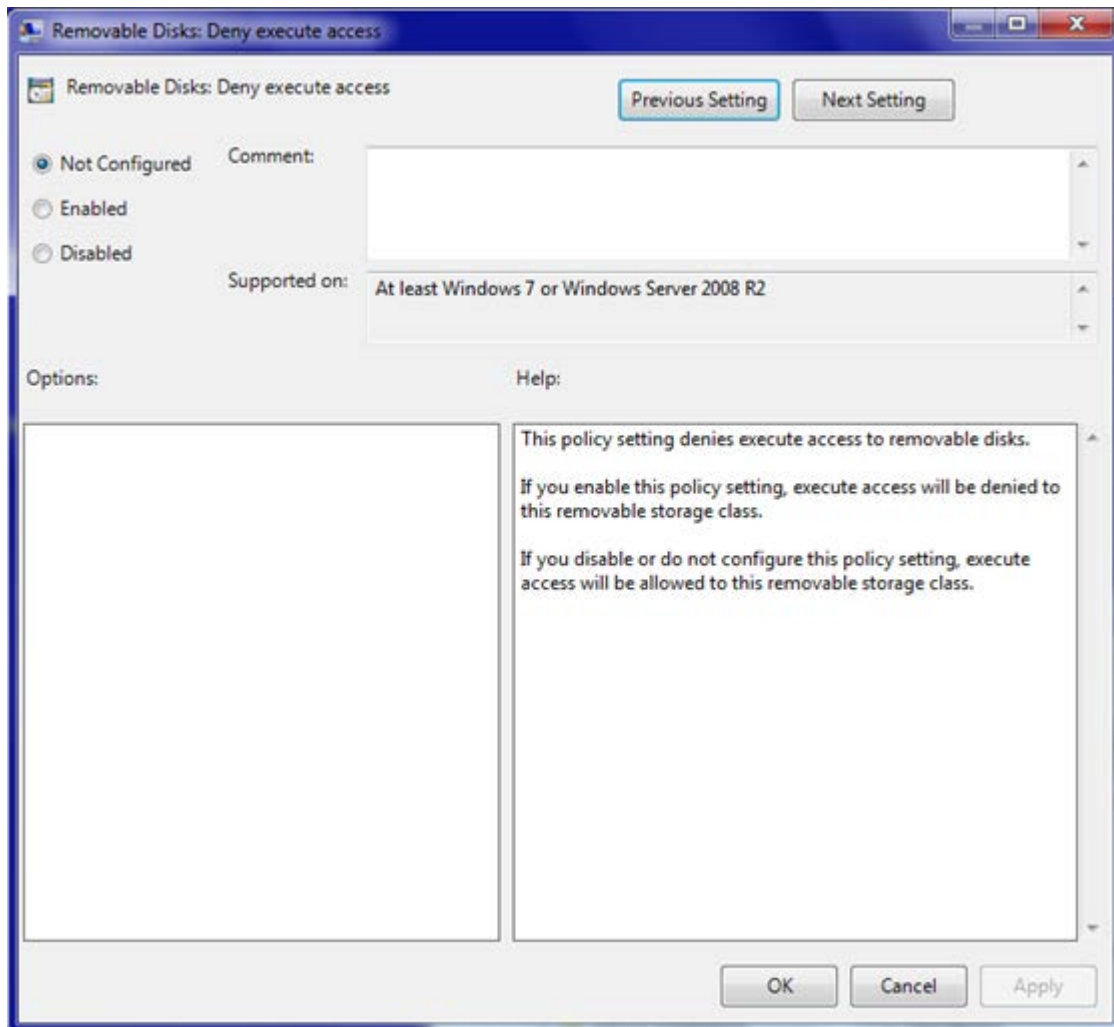

4. Select the desired option and click **Apply > OK** or just **OK**.
5. For example if your setting selection is **Removable Disk: Deny read access** and:
 - *Not Configured* option is selected (default selection) - allows read access to removable storage disks.
 - *Disable* option is selected - allows read access to removable storage disks.
 - *Enabled* option is selected - read access to removable disks is denied.

Connecting External Accessories

The E4990A can be connected to external input/output devices such as printer, monitor, keyboard and mouse.

- [Connecting a Printer](#)

- [Connecting a Mouse/Keyboard](#)
- [Connecting a Monitor](#)

[Other topics about Using Windows](#)

Connecting a Printer

A printer can be connected to the E4990A through any USB ports on the front or rear panels. Its driver may be required to install.

Connecting a Mouse/Keyboard

A USB mouse and USB keyboard can be connected to the E4990A through any USB ports on the front or rear panels.

Connecting a Monitor

A monitor can be connected to the E4990A using the [External Monitor Output Terminal \(Video\)](#) located in the rear panel of the E4990A.

NOTE

An external monitor needs to be connected to the analyzer and turned ON before the analyzer is turned ON so that the analyzer recognizes the monitor properly.

Product Information

Product Information

- [Options](#)
- [Documentations](#)
- [Specifications](#)
- Revision History
- [Customer Contacts](#)
- [Error Messages \(Warning Message\)](#)
- [Troubleshooting](#)
- [Measurement Accessories](#)
- [Maintenance](#)

Options for E4990A

The following list shows available options. Some options can be retrofitted on your E4990A. For upgrade (retrofit) kits, refer to <http://www.keysight.com/find/e4990a> and [configuration guide](#).

- [Frequency Options](#)
- [Time Base Options](#)
- [Software Options](#)
- [Accessory Options](#)
- [Calibration Option](#)
- [System Rack Options](#)

[Other topics about Product Information](#)

Frequency Options

Option Number	Description
E4990A-120	120 MHz
E4990A-050	50 MHz
E4990A-030	30 MHz

E4990A-020	20 MHz
E4990A-010	10 MHz

NOTE E4990A-050/030/020/010 has the following limitation.

- The 42941A and 42942A can not be used.
- Measurement speed is slower.

Time Base Options

Option Number	Description
E4990A-1E5	High Stability Time base

Software Option

Option Number	Description
E4990A-001	Enhanced Measurement Speed

NOTE E4990A-001 is available for option 050/030/020/010 only.

Accessory Options

Option Number	Description
810	Add Keyboard
820	Add Mouse

These options are not displayed at the [option information](#).

Calibration Option

Option Number	Description
A6J	ANSI Z540 Compliant Calibration
1A7	ISO 17025 Compliant Calibration

These options are not displayed at the [option information](#).

System Rack Options

Option	Description	Equivalent Part
--------	-------------	-----------------

Number		Number
1CM	Rack Mount Kit	5063-9216
1CN	Front Handle Kit	5063-9229
1CP	Rack Mount and Front Handle Kit	5188-4430

These options are not displayed at the [option information](#).

Documentations for E4990A

- [Manuals](#)
- [Sales Literature](#)

[Other topics about Product Information](#)

Manuals

The following documentations are provided with the E4990A.

Name	Description
Help (This file)	Provides the information about the measurement operation, programming, I/O interface.
Installation Guide	Provides information about start up setup and system recovery information when the Windows cannot be boot up. This is furnished with the E4990A as a hardcopy manual.
Service Guide	Provides information about the parts, troubleshooting, performance test, adjustment and service menu.

Both Installation Guide and Service Guide can be downloaded from <http://www.keysight.com/find/e4990a-manual>. The latest revision of Help System, Help in PDF and WebHelp formats are also available at the site.

Sales Literature

The following sales literatures are available on <http://www.keysight.com/find/e4990a>.

- [Brochure](#)
- [Data sheet](#)
- [Configuration Guide](#) (Ordering information)

- Application notes

Specifications

The Data Sheet which shows the E4990A specification is available at <http://literature.cdn.keysight.com/litweb/pdf/5991-3890EN.pdf>

The reader is required to see the PDF format.



[Other topics about Product Information](#)

Customer Contacts

For assistance on the E4990A, refer to <http://www.keysight.com/find/assist> for your regional customer contacts.

[Other topics about Product Information](#)

Error Message

Error and Warning Messages

- [Error Messages](#)
- [Warning Messages](#)

Warning Messages

A warning message is displayed in the instrument message/Warning area in the lower left part of the display against a gray background. Pushing a front panel key or executing :DISP:CCL command clears the message.

This message simply appears on the display, being not known to a remote environment such as a GPIB. This message is not displayed when another error (against a red background) has already been displayed in the instrument message/Warning area.

Warning Messages During Measurement

Messages	Description
Calibration data lost ([parameter])	One or more of the below calibration data is lost. The lost parameter is indicated in the message, for example, calibration data lost (band information): (nominal value), (band information), (frequency reference), (DC Bias), (constants for sweep

E4990A Impedance Analyzer Help

	controller), (trd band information), (synthesizer source level), (synthesizer local level), (DC monitor), (DC Ps Frequency), (range tbl), (er tbl), (srr att tbl), (gain tbl), (src vnr), (null GP 0m), (null GP 2m), (null GP probe), (null GP 7mm), (trdscy), (trd DC dac), (lo null dac), (IFBW), (mod ADC Ofs), (mod DAC Ofs), (AC level monitor), (ADC linearity), (compression), (rangeR), (Imp0m), (Imp1m), (Imp2m), (Imp7mm), (ImpProbe), (R100Ls), (WaitTimeTbl), (IfBwC).
DC Bias overload	When the dc bias is applied, dc current that exceeds the setting of the DCI range (<1mA, <10mA, or <100mA) is supplied from the bias source, or the overcurrent limit circuit of the dc bias source takes effect. Increase the setting of the dc bias range or decrease the level of the applied dc bias.
Invalid key code	The key code entered to enable or disable an option is incorrect. Enter the correct key code to proceed.
Reduce OSC Level	The oscillator level is considerably higher than the measured $ Z $ (absolute value of impedance) of the DUT, causing increased nonlinear measurement error that cannot be ignored. This message is displayed when the oscillator level is set to greater than 0.5 V while $ Z $ of the DUT is smaller than 48 ohm. To avoid this error, set the oscillator level below 0.5 V.
Unable to find help file	This warning message appears when Help file could not be executed when you press the Help key. The file is either corrupted or unavailable. Re-install the firmware.
Unable to find help id file	This warning message appears when Help file could not be executed when you click a button at the menu bar and press the Help key to execute a help topic related to the button. The help id file is either corrupted or unavailable.
Unknown SSD image	This message appears when wrong SSD is installed.
Unknown system revision	This message appears when wrong SSD is installed.

Z measurement overload	The internal circuit (ADC) is temporarily overloaded. Measurement data when this error occurs is invalid.
------------------------	---

Error Messages

An error message is displayed against a red background in the instrument message/warning area in the lower left part of the screen. Pushing a front panel key or executing :DISP:CCL command clears the error message. Errors caused by the operation of a front panel key simply appear on the display. They are not stored in the error queue with some exceptions.

An error with a positive error number is one uniquely defined for this instrument. On the other hand, an error with a negative error number is basically one defined for common GPIB devices in IEEE488.2

[A](#) [B](#) [C](#) [D](#) [E](#) [F](#) [G](#) [H](#) [I](#) [J](#) [K](#) [L](#) [M](#) [N](#) [O](#) [P](#) [Q](#) [R](#) [S](#) [T](#) [U](#) [V](#) [W](#) [X](#) [Y](#) [Z](#)

A

No.	Message	Description
221	AC constant operation failed	This error occurs when AC constant operation fails to execute.
10	Additional standard needed	The GPIB command that turns ON the calibration function has been sent before all the data measurements required to calculate the calibration factor have been completed. Be sure to measure all the necessary calibration data before sending commands. This error is not generated by front key operations.

B

No.	Message	Description
-168	Block data not allowed	An block-data element has been received at a position where this instrument does not accept one.

C

No.	Message	Description
97	Calculate equivalent	This error occurs when equivalent

	parameter failed	parameter calculation fails.
59	Calibration aborted. Stimulus settings exceeded the parameters of original calibration / compensation	<p>One of the following problems has occurred.</p> <ul style="list-style-type: none"> • In the middle of or after the completion of the setup for user calibration or fixture compensation (measurement of required calibration data and calculation and storage of error coefficients), the setting of calibration points (FIXED or USER) is changed. The current setup and error coefficients previously stored become invalid. • When the setting of calibration points is USER, in the middle of or after the completion of the setup for user calibration or fixture compensation (measurement of required calibration data and calculation and storage of error coefficients), the sweep condition (sweep range, sweep parameter, number of sweep points, sweep type) is changed. The current setup and error coefficients previously stored become invalid. • In the middle of the setup for user calibration or four-terminal pair extension (measurement of required calibration data and calculation and storage of error coefficients), the setup is canceled (the cancel key command is executed). The setup is invalid, but error coefficients previously stored are still available. <p>If necessary, again perform the setup for user calibration, fixture compensation, or four-terminal pair extension.</p>
58	Calibration / Compensation	This error occurs when calibration and compensation are interpolated.

	interpolated	
240	Calibration data lost	This error occurs when a file containing the system calibration data is not found or in a damaged state at time of the startup of this instrument, indicating a failure of this instrument. Contact the Keysight Technology sales office or the company from which you bought the instrument.
12	Calibration not usable	A command to execute data measurement for unnecessary (not allowed) calibration (user calibration or fixture compensation) for the current adapter selection is sent. The command is invalid. For example, when NONE (no adapter) is selected as the adapter selection, sending the CALA command, which executes OPEN data measurement for the user calibration, causes this error (when the adapter selection is NONE, you cannot execute the user calibration). Execute the measurement of necessary (allowed) calibration data for the current adapter selection.
11	Calibration required	In user calibration, although error coefficients based on the measurement of the required calibration standards (OPEN, SHORT, or LOAD) have not been acquired, a GPIB command to turn on the user calibration function is sent. Valid error coefficients are not detected, and the command is invalid. For user calibration, it is necessary to measure all calibration standards (OPEN, SHORT, LOAD) and acquire error coefficients based on the measurement.
- 148	Character data not allowed	A character data element (not violating the standard) has been received at a position where this instrument does not accept one. Double quotes (") are omitted

E4990A Impedance Analyzer Help

		where it is necessary to place a parameter in double quotes ("), for example.
- 100	Command error	A comprehensive syntax error has occurred showing that this instrument cannot detect a more detailed error. This code simply shows that a command error defined in 11.5.1.1.4, IEEE488.2 has occurred.
90	Compensation required	In fixture compensation, although error coefficients based on the measurement of the required calibration standards (OPEN, SHORT, or LOAD) have not been acquired, a GPIB command to turn on the fixture compensation function is sent. Valid error coefficients are not detected, and the command is invalid. For fixture compensation, it is necessary to measure a calibration standard (OPEN, SHORT, or LOAD) corresponding to the fixture compensation function (OPEN compensation function, SHORT compensation function, or LOAD compensation function) you select and obtain error coefficients based on the measurement.
460	Continuous switching may damage source switch	This error occurs when different power ranges are selected in multiple channel measurement settings to avoid source attenuator damage.

D

No.	Message	Description
- 222	Data out of range	A data element (not violating the standard) outside the range defined by this instrument has been received. This error occurs when an integer-based command for which the parameter can be rounded exceeds the range of -65536 to +65536 or when a real-number-based command for which the parameter can be rounded exceeds the range of -

		<p>9.9e37 to +9.9e37, for example.</p> <p>This error occurs also when a numeric value other than a specified one is entered into a command in which the "port number" and "CalKit number" are specified as parameters and hence the parameters are not rounded.</p>
- 104	Data type error	The parser has recognized a data element that must not exist. Block data has been sent instead of numeric value data or character string data that had been expected, for example.
63	DC Bias constant operation failed	This error occurs when DC Bias constant operation fails to execute.

E

No.	Message	Description
502	Equation runtime error	<p>This error occurs under the following conditions:</p> <ul style="list-style-type: none"> The trace number in <code>data(tr)/mem(tr)/xAxis(tr)</code> is out of range # of trace available depends on the maximum number of channel/traces The port number in Advanced math function is out of range # of port available depends on the model option
95	Equivalent circuit analysis not allowed	This error occurs when equivalent circuit analysis is not allowed to be executed.
- 200	Execution error	An error associated with execution has been generated for which this instrument cannot specify the error message. This code shows that an error associated with execution defined in 11.5.1.1.5, IEEE488.2 has occurred. This error also occurs when a calibration measurement is aborted.
-	Exponent too	The absolute value of the exponent exceeds 32,000

E4990A Impedance Analyzer Help

123	large	(see 7.7.2.4.1, IEEE488.2).
- 178	Expression data not allowed	An expression-data element has been received at a position where this instrument does not accept one.
- 170	Expression error	When the expression data is put to syntactic analysis, an error not corresponding to one of Error Numbers -171 through -179 occurs.

F

No.	Message	Description
102	Failed to copy file	This error occurs when copying a file (MMEM: COPY command) fails.
104	Failed to create directory	This error occurs when creating a directory (MMEM: MDIR command) fails.
103	Failed to delete file	This error occurs when deleting a file (MMEM: DEL command) fails.
100	Failed to read file	This error occurs when a 2-port touchstone file (CALC: FSIM: SEND: PMC: PORT: USER: FIL command), the formatted data array (MMEM: LOAD: FDAT command) and limit table (MMEM: STOR: LIM command) for the active trace on the active channel, segment sweep table (MMEM: LOAD: SEGM command) for the active channel, a VBA project file (MMEM: LOAD: PROG command), etc. cannot be read normally.
101	Failed to write file	This error occurs when the formatted data array (MMEM: STOR: FDAT command) and limit table (MMEM: STOR: LIM command) for the active trace on the active channel, segment sweep table (MMEM: STOR: SEGM command) for the active channel, display image (MMEM: STOR: IMAG command) for the LCD screen, a VBA project file (MMEM: STOR: PROG command), etc. cannot be written normally.
- 257	File name error	A file name error. This message appears when an error exists in the file name and hence a command is not executed correctly. This error occurs when you try

		to copy to an unsuitable file name, for example.
- 256	File name not found	The file name specified is not found and hence the command is not executed correctly. This error occurs when you try to read a file that does not exist in a disk or a disk is not correctly inserted into the drive to read or write a file, for example.
201	Firmware license not found	Frequency option or/and Generation code license codes do not exist in .lic file.
56	Frequency sweep only	When a sweep parameter other than frequency is specified, you attempt to execute an equivalent circuit analysis command. You can execute the equivalent circuit analysis only when the sweep parameter is frequency.

G

No.	Message	Description
- 105	GET not allowed	A group execution trigger (GET) has been received in the program message (see 7.7, IEEE488.2).

H

No.	Message	Description
- 240	Hardware error	The program command cannot be executed due to a hardware-related error. This indicates that an error other than -241 to -249 has occurred.
- 114	Header suffix out of range	The unit of the header is outside the range. The header is invalid in the unit for numeric parameters following a SCPI command.

I

No.	Message	Description
- 224	Illegal parameter value	This error occurs when the parameter value is not suitable. It also occurs because the number of specified traces exceed the maximum number of trace set.
- 282	Illegal program	This error occurs when a nonexistent VBA program name is specified by the PROG:SEL:NAME

E4990A Impedance Analyzer Help

	name	command.
- 213	Init ignored	Because another measurement is in progress, the request for initiating a measurement ("INIT" command) is ignored.
243	Insufficient privileges	This error occurs when multiple processes are executed at the same time and the memory is exhausted, which causes the last process to be aborted. In this case, terminate some of the processes and then perform the next operation.
- 161	Invalid block data	Block data has been expected, but the block data that appears is invalid for some reason (see 7.7.6.2, IEEE488.2). The END message is received before the length of block data has been filled, for example.
28	Invalid calibration method	This error occurs when the type of calibration is not specified or not correct when partial overwrite is executed with the GPIB command. This error does not occur for operation with front keys.
- 101	Invalid character	An invalid character exists in the program message character string.
- 141	Invalid character data	An invalid character is found in the character data element, or the parameter received is not valid.
- 121	Invalid character in number	A character that is invalid for the data type subject to syntactic analysis has been received. For example, a letter is found in a decimal numeric value or a numeric character "9" in octal data.
501	Invalid equation expression	The equation expression used in Equation Editor is not valid.
502	Invalid equation label	The equation label used in Equation Editor is not valid.
- 171	Invalid expression	The expression-data element is invalid (see 7.7.7.2, IEEE488.2). Parentheses are not paired, or illegal characters are used, for example.

- 232	Invalid format	An invalid format is received.
- 103	Invalid separator	The parser (a syntactic analysis program) had been expecting a delimiter, but a character that is not a delimiter has been sent.
- 151	Invalid string data	Character string data has been expected, but the character string data that appears is invalid for some reason (see 7.7.5.2, IEEE488.2). The END message is received before the ending quotation mark character appears, for example.
- 131	Invalid suffix	The suffix does not comply with the syntax defined in 7.7.3.2, IEEE488.2. Or it does not suit E4990A.

L

No.	Message	Description
53	Log sweep requires an octave minimum span	<p>The span of sweep range is not satisfied the requirement for logarithmic sweep. The sweep type is automatically changed to linear sweep when this error occurs.</p> <p>For example, this error occurs when, with the start and stop frequency are set 1 MHz and 2 MHz respectively, the sweep type is changed to logarithmic sweep.</p> <p>Set the stop frequency to more than four times as many as the start frequency. And then select logarithmic sweep.</p>

M

No.	Message	Description
- 270	Macro error	The error occurs when wrong macro is executed.
+60	Maximum wait time exceeded	<p>Total time of wait time has been exceeded the limit.</p> <ul style="list-style-type: none"> • Normal Sweep: Sweep delay + Point delay + Sweep Time/(Number of points) = < 67 sec. • Segment Sweep: Sweep delay + Segment

		delay + Point Delay Sweep Time/(Number of points) = < 67 sec.
- 109	Missing parameter	<p>The number of parameters is less than that required for the command, or the parameter has not been entered. For example, the command SENS{1-6}:SWE:POIN requires one more parameter.</p> <p>Therefore, when a message "SENS1:SWE:POIN" is sent to a correct program message "SENS1:SWE:POIN 201" this instrument receives the former message as an invalid one because all parameters have not been entered. Enter command parameters correctly.</p>
55	Measurement parameter not for analysis	<p>When a measurement parameter other than Z -q is set, you attempt to execute a waveform analysis command (for example, OUTPCERR?) and, as a result, the command is ignored.</p> <p>Before executing a waveform analysis command, set the measurement parameter to Z -θ.</p>
96	Must be more than 2 points for analysis	<p>Although the calculation of equivalent circuit parameters is executed, because the number of points (NOP) within the sweep range (if the partial search function is on and within the specified search range) is two, they cannot be calculated. Set the number of points within the sweep range (if the partial search function is on, within the specified search range) to three or more.</p>

N

No.	Message	Description
- 120	Numeric data error	An error resulting from the numeric value data (including numeric value data having no decimal point representation) has occurred. A numeric value error other than Errors -121 through -129 has occurred.
- 128	Numeric data not allowed	An numeric-value-data element (not violating the standard) has been received at a position where this instrument does not accept one.

52	No valid memory trace	This error occurs when you have executed either DISP:WIND:TRAC:MEM ON command to display memory trace, or any other command to enable data calculation using memory trace (CALC:MATH:FUNC command with other than NORM is specified), though no valid data exists in memory trace. This error is not generated by front key operations.
----	-----------------------	---

O

No.	Message	Description
200	Option not installed	The command received has been ignored because of the mismatch between the contents of an option for this instrument and the command. It also occurs when you try to enable the time domain function in a model not having the time domain option. This holds true for the frequency offset option. This error is not generated by front key operations.
- 225	Out of memory	Insufficient memory is available in this instrument to perform the required operation.

P

No.	Message	Description
- 220	Parameter error	When a parameter-related error other than Errors - 221 through -229 occurs, that error is displayed.
- 108	Parameter not allowed	The number of parameters exceeds that required for the command. For instance, when a program message ":SENS1:SWE:TYPE LIN, SEGM" is sent instead of a correct program message with a command ":SENS1:SWE:TYPE LIN" which requires a parameter, the instrument receives the message as the number of parameters is invalid. See the command reference to confirm the required number of parameters.
41	Peak not found	This error occurs when, after specifying a peak and executing the CALC:MARK:FUNC:EXEC and CALC:FUNC:EXEC commands, the specified peak is

E4990A Impedance Analyzer Help

		not found in the marker search analysis.
220	Phase lock loop unlocked	This error occurs when the PLL circuit of this instrument becomes unlocked while the measurement is in progress. The measurement value is not correct. This error may occur when an external reference out of specification is connected to this instrument. Should an error occur with an external reference not connected, this instrument is faulty. Contact the sales office or the company from which you bought the instrument.
106	Printer error	This error occurs when the previous printing is still in progress or the printer fails (offline, short of paper, etc.) at time of outputting the display image on the LCD screen to the printer (HCOP:IMM command).
120	Print failed	This error occurs when printing fails for reasons other than Error 120, Printer error.
241	Power on test failed	This error occurs when the power-on test fails, indicating a failure of this instrument. Contact the sales office or the company from which you bought the instrument.
- 284	Program currently running	This error occurs when the PROG:SEL:STAT RUN command is executed with the VBA program in the Run state.
- 112	Program mnemonic too long	The length of the header exceeds 12 characters (see 7.6.1.4.1, IEEE488.2).
- 286	Program runtime error	An error occurring when VBA /macro is executed.

Q

No.	Message	Description
- 430	Query DEADLOCKED	The state that generates a "DEADLOCKED" Query error (see 6.3.1.7, IEEE488.2). This error occurs when both input and output buffers have become full, preventing the instrument from continuing processing, for

		example.
- 400	Query error	A comprehensive query error has occurred showing that this instrument cannot detect a more detailed error. This code simply shows that a query error defined in 11.5.1.1.7 and 6.3, IEEE488.2 has occurred.
- 410	Query INTERRUPTED	The state that generates a "INTERRUPTED" Query error (see 6.3.2.3, IEEE488.1). This error occurs when data bytes (DAB) or GET are received before the transmission of the response after a query has not been completed, for example.
- 350	Queue overflow	The queue contains a specific code in place of the code which caused this error. The code indicates that the error occurred because of no space available in the queue, but the error is not recorded.
- 420	Query UNTERMINATED	The state that generates an "UNTERMINATED" Query error (see 6.3.2, IEEE488.2). This error occurs when this instrument is designated as the talker and an incomplete program message is received, for example.
- 440	Query UNTERMINATED after indefinite response	After a query asking for an indefinite response has been run, another query is received in the same program message (See 6.5.7.5.7, IEEE488.2).

R

No.	Message	Description
105	Recall failed	This error occurs when reading an instrument status file (State01.sta, etc.) (MMEM:LOAD:STAT command) fails.
45	Reference tracking not allowed with Log-Y scale	This error occurs when Log-Y scale is set and reference tracking is attempted.

S

E4990A Impedance Analyzer Help

No.	Message	Description
106	Save failed	This error occurs when writing an instrument status file (State01.sta, etc.) (MMEM:STOR:STAT command) fails.
54	Set start and stop DC value as positive and an octave minimum span to select Log DC Bias sweep	This error occurs when Log DC Bias sweep is selected but start DC value is not set to positive and stop DC value is not set to correct minimum span.
50	Specified channel hidden	This error occurs when an attempt is made to activate a channel not on display using the DISP:WIND:ACT command. This error is not generated by front key operations.
51	Specified trace does not exist	This error occurs when CALC:PAR:SEL command is executed to activate more traces than specified by CALC:PAR:COUN command. This error is not generated by front key operations.
57	SnP request not valid	<p>This error occurs when you try to save data to a Touchstone file but no measurement has been executed.</p> <p>This error also occurs when you try to save a Touchstone file with power sweep measurement specified or with the frequency offset function set to ON.</p>
- 150	String data error	When a character-string-data element is put to syntactic analysis, an error not corresponding to one of Error Numbers - 151 through -159 occurs.
- 158	String data not allowed	A character-string-data element has been received at a position where this instrument does not accept one.
- 138	Suffix not allowed	A suffix is attached to a numeric value element to which a suffix is not allowed to be attached.
-	Suffix too long	The unit is too long.

134		The unit is expressed in 12 or more characters (see 7.7.3.4, IEEE488.2).
- 102	Syntax error	A command or data type that is not recognized exists.
- 310	System error	One of the errors designated as "system errors" in this instrument has occurred.

T

No.	Message	Description
40	Target value not found	This error occurs when the target is not found during the marker search analysis after specifying the target and executing the CALC:MARK:FUNC:EXEC and CALC:FUNC:EXEC commands. This error occurs also when the bandwidth is not found after executing the bandwidth marker command, CALC:MARK:BWID:DATA?
- 124	Too many digits	The number of digits of the argument of the decimal numeric-value-data element exceeds 255 with the preceding 0 removed (see 7.7.2.4.1, IEEE488.2).
- 223	Too much data	The block-, expression-, or character-string-type program data that has been received conforms with the standard. But it exceeds the amount that can be processed under the condition of the memory or conditions specific to memory-related devices. In this instrument, this error occurs when the number of characters exceeds 254 in a character-string parameter.
- 211	Trigger ignored	This instrument receives and detects a trigger command ("TRIG") or an external trigger signal. But it is ignored due to the timing condition (This instrument is not in the wait-for- trigger state, for example). Change the setup so that a trigger command or an external trigger signal can be sent after the instrument has entered the wait-for- trigger state.

U

No.	Message	Description
-	Undefined	A command not defined in this instrument, though not

E4990A Impedance Analyzer Help

113	header	illegal in the syntactic structure, has been received. For example, when a message ":DISP:WIND1:TABL:MEM ON" is sent to a correct program message ":DISP:WIND1:TRAC1:MEM ON," the message sent is received as an undefined command by this instrument. See the command reference and use correct commands.
-----	--------	--

Troubleshooting

This section describes the steps you should take when you believe that the E4990A is operating improperly. The results of these simple investigative procedures may help you avoid the down-time and inconvenience of repair service. The troubleshooting instructions are divided into three categories.

When all troubleshooting measures are taken but it does not work. Contact [Keysight Technology's Customer Contact](#).

- [Troubleshooting during Startup](#)

- [Troubleshooting during Operation](#)
- [Troubleshooting for External Devices](#)

Troubleshooting during Startup

Symptom	Solution
Turning ON () the standby switch does not start up the system.	<ul style="list-style-type: none"> • Confirm that the power cable is properly plugged in. • Confirm that the line switch on the rear panel is turned ON.
Standby switch color is red and does not start up the system.	There is some trouble on the fan. Turn OFF and ON the line switch once, then turn ON this standby switch.
The system starts up, but it automatically shuts down immediately.	Execute the system recovery .
The system starts up, but it enters the service mode (The instrument status bar in the lower right part of the screen displays SVC in red).	Execute the system recovery .
The measurement screen appears after startup, but the date and time displayed on the instrument status bar in the lower right part of the screen differ greatly from the previous settings.	Execute the system recovery .
The measurement screen appears after startup, but the power-on test fails, with Error Message 241 appearing against the red background in the instrument message/warning area in the lower left part of the screen.	Execute the system recovery .

Troubleshooting during Operation

Symptom	Solution
---------	----------

<p>A clearly abnormal measurement value</p> <p>The measurement value is not reproducible, or clearly abnormal.</p>	<ul style="list-style-type: none"> • Confirm that the DUT, connection cables, and other parts are connected correctly. • Confirm that the connectors and cables used to connect the DUT are free from damage and poor contact. • Confirm that the calibration has been executed correctly. If you have not acquired a correct error correction factor, you cannot obtain a correct measurement value. • Confirm that the calibration kit is selected correctly. • Confirm that the calibration kit is defined correctly. • Confirm that if the stimulus signal output is turned ON.
<p>The system cannot operate manually (Front Panel Keys, Keyboard, Touch Screen and Mouse)</p> <p>The keyboard or mouse becomes inoperable.</p>	<ul style="list-style-type: none"> • Confirm that the keyboard or mouse is connected correctly. When it is connected correctly, turn OFF the power once, and restart the system.
<p>The front panel key or keyboard becomes inoperable.</p>	<ul style="list-style-type: none"> • Using the mouse, turn System > Key Lock > Front Panel & Keyboard Lock OFF.
<p>The touch screen becomes inoperable.</p>	<ul style="list-style-type: none"> • Using the front panel keys, press System > Key Lock > Touch Screen & Mouse Lock OFF to turn OFF the lock. • Execute the calibration of the touch screen.
<p>The mouse becomes inoperable.</p>	<ul style="list-style-type: none"> • Using the front panel keys, press System > Key Lock > Touch Screen & Mouse Lock to turn OFF the lock.

E4990A Impedance Analyzer Help

<p>All of the front panel keys, keyboard, and mouse become inoperable.</p>	<ul style="list-style-type: none"> • Confirm that the keyboard or mouse is connected correctly. When it is connected correctly, turn OFF the power once, and restart the system.
<p>The keyboard and mouse have been connected after power-on.</p>	<ul style="list-style-type: none"> • Turn OFF the power once, and restart the system. When taking all these measures does not recover operability, there is a possibility of a failure.
<p>The screen freezes and all operations become impossible. The measurement in progress or screen update is stalled and all of the front panel keys, keyboard, mouse, and touch screen are inoperable.</p>	<ul style="list-style-type: none"> • Press the standby switch to turn OFF the power once, and restart the system.
<p>The system freezes while in operation.</p>	<ul style="list-style-type: none"> • Press the standby switch to turn OFF the power once, and restart the system.
<p>The rear cooling fan does not operate.</p>	<ul style="list-style-type: none"> • There is a possibility of a failure.
<p>The sweep action stops during measurement or is not executed. An error or warning message appears.</p>	<ul style="list-style-type: none"> • There is a possibility of a failure.
<p>An error or warning message is displayed on the instrument message/warning area in the lower part of the screen</p>	<ul style="list-style-type: none"> • Refer to Error Messages and Warning Messages.

Troubleshooting for External Devices

Symptom	Solution
---------	----------

<p>Cannot output to a printer Cannot output a measurement screen or data to a printer. Attempting to output to a printer causes Error Messages 120 and 121 to appear.</p>	<ul style="list-style-type: none"> • Confirm that the power to the printer is turned ON and that the line cable is connected correctly. • Confirm that the connector cable of the printer is connected correctly. • Confirm that the printer is online. • Confirm that the printer has not run out of paper. • Confirm that the printer has not run out of ink.
<p>Does not respond to an external controller/fails to function normally A GPIB device does not respond to the external controller, or fails to function normally.</p>	<ul style="list-style-type: none"> • Confirm that the GPIB address is defined correctly. • Confirm that the GPIB cable is connected. • Confirm that another instrument connected by the GPIB cable has the same GPIB address. • Confirm that the GPIB cable connection forms a loop.

Measurement Accessories

There are various fixture and adapters. Refer to Accessories Selection Guide For Impedance Measurements (<http://literature.cdn.keysight.com/litweb/pdf/5965-4792E.pdf>) for more information.

[Other topics about Product Information](#)

Maintenance

Maintenance

- [Cautions Applicable to Requesting Repair, Replacement, Regular Calibration, etc.](#)

- [Cleaning this Instrument](#)
- [Replacement of Parts with Limited Service Life](#)
- [System Recovery](#)
- [Updating Firmware](#)
- [Service Functions](#)
- [Removing Log Data](#)

Cautions Applicable to Requesting Repair, Replacement, Regular Calibration, etc.

- [Backing Up Data in the storage](#)
- [Devices to be Sent Back for Repair or Regular Calibration](#)

[Other topics about Maintenance](#)

Backing Up Data in the storage

The user is requested to back up the stored programs and data into external media by using the instrument's storing function before requesting the Company's Service Center to repair the instrument or replace storages.

See Making Backup Files for how to make backup files.

Please take note that the Company will not be held liable to any extent for potential erasure or change of stored programs or data due to the repair or replacement of storages performed by the Company. When a storage itself fails, the programs and data stored in it cannot be recovered.

Devices to be Sent Back for Repair or Regular Calibration

If it is necessary to send the unit to the Service Center of Keysight Technologies for repair or regular calibration, please follow the instructions below.

Equipment to be Sent

When requesting repair or regular calibration of the unit by our Service Center, send only the E4990A main unit without any installed option you may have ordered. Unless specifically instructed, it is not necessary to send accessories and calibration kits.

Packing

Use the original package and shock absorbers, or equivalent anti-static packing materials, when sending the unit.

Shipping Address

For the location of the nearest Keysight Technologies Service Center, contact the [Customer Contact](#).

Recommended Calibration Period

The recommended calibration period for this instrument is one year. The user is recommended to request the Company's Service Center to perform regular calibration every year.

Cleaning this Instrument

- [Cleaning an LCD](#)
- [Maintenance of Test Ports and Other Connectors/Ports](#)
- [Cleaning Parts Other than the LCD, Test Ports, and Other Connectors/Ports](#)

[Other topics about Maintenance](#)

This section describes how to clean the instrument.

To protect yourself from electrical shock, be sure to unplug the power cable from the outlet before cleaning the instrument.

Never clean the internal components of the instrument.

Cleaning an LCD

Use one of the following methods to clean the display surface regularly.

- For normal cleaning, rub the surface gently with a dry, soft cloth.
- When stains are difficult to remove, gently wipe the surface with cloth dampened with a small amount of dehydrated ethanol. You can clean the standard LCD (no touch screen function) with a cloth dipped in water and then wrung tightly.

NOTE

Do not use chemicals other than dehydrated ethanol to wet the cleaning cloth. To clean the touch screen LCD, do not wet the cloth with water.

Maintenance of Test Ports and Other Connectors/Ports

The ports of the E4990A are fitted with BNC connectors. Stains or other damage to these connectors would significantly affect the accuracy in measurements. Always pay attention to the following precautions.

- Always keep the connectors free from stains and dust.
- Do not touch the contact surface on the connectors.
- Do not plug damaged or scratched connectors into the test ports.
- Use compressed air for cleaning connectors. Do not use abrasives under any circumstance.

The above precautions must also be observed in maintaining connectors and ports other than these test ports.

Cleaning Parts Other than the LCD, Test Ports, and Other Connectors/Ports

To remove stains on parts other than the LCD, test ports, and other connectors/ports of the instrument, wipe them gently with a soft cloth that is dry or wetted with a small amount of water and wrung tightly.

Replacement of Parts with Limited Service Life

This instrument incorporates parts with limited service life as shown in the following table. Using the recommended replacement time as a guide, request the Keysight Service Center to replace these parts. However, a part may need to be replaced at an earlier time than that listed in the table, depending on conditions such as location, frequency of use, and where it is stored.

NOTE

Each service life and recommended replacement time listed below is for reference only and does not imply a guarantee of the part's service life.

Part Name	Service Life (Parts supplier reference value)	Recommended replacement time
Solid State Drive (SSD)	5 years or 20,000 operating hours, whichever comes earlier. Exchanging hard disk drives causes the contents written after shipment from the factory (LAN setup, etc.) to be initialized to the state at the time of shipment. The programs and data stored in Drive D (user directory) are erased.	3 years
Main fan	50,000 operating hours. The service life may be significantly shorter when used in a dusty and dirty environment.	5 years
CPU fan		
Battery on Mother board	50,000 operating hours. The service life may be shorter if E4990A power has not been turned on for long time.	5 years
Power supply	50,000 operating hours (Depends on the service life of the power supply cooling fan) The service life may be significantly shorter when used in a dusty and dirty environment.	5 years

LCD screen backlight	50,000 operating hours. When the unit is used for automatic measurements in a production line and the on-screen information is not required, the life of the LCD backlight can be saved by turning it OFF. As for the method of turning the backlight OFF, refer to Turning OFF the LCD Screen Backlight .	5 years
Touch screen (function)	One million times (dotting life)	5 years
USB receptacle	1,500 cycles insertion/extraction. The service life may be shorter when used in a dusty and dirty environment. In case that the insertion/extraction is in heavy usage such as USB memory stick, using USB extension cable may save the USB receptacle life.	N/A

[Other topics about Maintenance](#)

System Recovery

By executing system recovery, you can return the Windows operating system of the E4990A to the factory state or the user state at the setting the user performed save user state.

The procedure of system recovery is described in both [Installation Guide](#).

[Other topics about Maintenance](#)

Updating Firmware

- [Overview](#)
- [Procedure](#)

[Other topics about Maintenance](#)

Overview

User can update E4990A firmware by themselves. The latest firmware can be downloaded from the <http://www.keysight.com/find/e4990a>

Updating firmware does not include the following software update.

E4990A Impedance Analyzer Help

- Windows Operating System
- Driver for Windows
- Calibration Constant Data

NOTE

Firmware update can only be performed with administrator account.

Procedure

Firmware Revision A.02.xx and above

1. Press **System** > **Service Menu** > **Exit** to terminate the E4990A application.
2. Download the latest firmware from the [download site](#). (**E4990A.exe**). If you use your local PC to download, save the file to a USB mass storage device in order to move it to E4990A, then connect the USB mass storage device into the front USB port of the E4990A.
3. Double click **E4990A.exe** to install the firmware.
4. Follow the instruction of windows installer. After the installation is finished, the instrument restarts.
5. Press **System** > **Firmware Revision** to confirm the firmware revision you have just installed.

Firmware Revision A.01.xx

1. User should log in as an administrator authority to perform firmware update.

NOTE

Download the latest firmware from the [download site](#). It is prepared as execution file (**E4990A_xx.xx.exe**).

NOTE

Run the **E4990A_xx.xx.exe** to extract the **E4990A.msi**.

If you use your local PC to download, save the file to a USB mass storage device in order to move it to E4990A, then connect the USB mass storage device into the front USB port of the E4990A.

2. Press **System** > **Service Menu** > **Update Firmware**.
3. In Open dialog box, select **E4990A.msi**, then press **Open**. Then the windows installer appears.
4. Follow the instruction of windows installer. After the installation is finished, the instrument restarts.
5. Press **System** > **Firmware Revision** to confirm the firmware revision you have just installed.

Service Functions

This menu (**System** > **Service Menu** > **Test** and **Service Functions**) provides information about various test related to the E4990A.

For more information about any test related to the E4990A, refer to the E4990A [Service manual](#).

[Other topics about Maintenance](#)

Removing Log Data

The E4990A creates automatic log of data for troubleshooting purpose. For security reasons, if this data needs to be deleted, then `:SERV:LOGG:CLE` command can be used to clear the log recorded by the E4990A.

The log file stores data related to:

- Power ON time
- Number of times of power ON
- Result of power ON test
- Number of times of overload
- Event Log
- Hardware driver installation/error Log
- Connected USB device Log
- User calibration Log
- Firmware error Log
- Temperature of analog boards
- Internal test result

Programming

Programming

- Remote Control
- [Command Reference](#)

Remote Control

Overview

Overview

- [Types of Remote Control System](#)
- [GPIB Remote Control System](#)
- [LAN Remote Control System](#)
- [USB Remote Control System](#)
- [Sending SCPI Command Messages](#)

Types of Remote Control System

Depending on the system controller and the interface, you can configure 5 types of remote control system as shown in the table below.

System controller	Interface	Overview
External controller (external computer such as PC and workstation)	GPIB (talker/listener mode)	System to control the E4990A and other devices connected via GPIB from the external controller. For more information, refer to GPIB remote control system .
	LAN	System to control the E4990A and other devices connected via LAN from the external controller. For more information, refer

		to LAN remote control system .
	USB	System to control the E4990A and other devices connected via USB from the external controller. For more information, refer to USB Remote Control System .
E4990A	None (Internal Connection)	Not supported
	GPIB (system controller mode)	Not supported

GPIB remote control system

- [About GPIB](#)
- [System Configuration](#)

[Other topics about Overview](#)

About GPIB

GPIB (General Purpose Interface Bus) is an interface standard for connecting computers and peripherals, which supports the following international standards: IEEE 488.1, IEC-625, IEEE 488.2, and JIS-C1901. The GPIB interface allows you to control the Keysight E4990A from an external computer. The computer sends commands and instructions to the E4990A and receives data sent from the E4990A via GPIB.

System Configuration

Use GPIB cables to connect between the E4990A, the external controller (computer), and peripherals. The following figure shows the overview of the system configuration of the GPIB remote control system.

Configuration of the GPIB remote control system

E4990A Impedance Analyzer Help

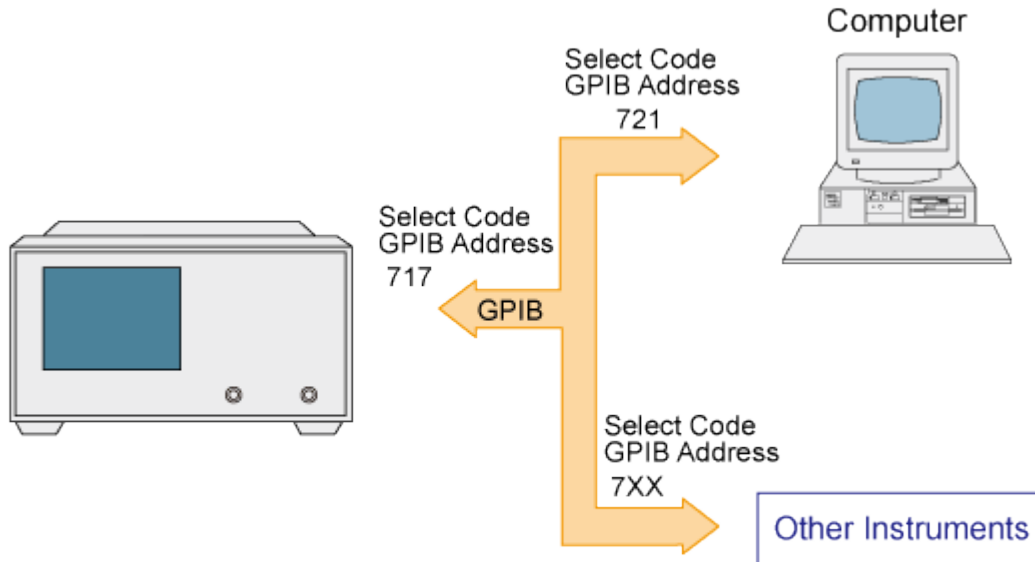

e5061b054

While the E4990A is turned OFF, the SRQ status of the E4990A is active. To prevent an incorrect operation on the SRQ of the GPIB remote control system, disconnect the E4990A from the system when the E4990A is turned OFF.

Required Equipment

- E4990A
- External controller (PC or workstation that can be connected to LAN and Keysight I/O Library is installed into)
- Other devices (other instruments and/or peripherals that serve your purpose)
- GPIB cables

Scale of system you can construct

- You can connect up to 15 devices in a single GPIB system.
- The length of cables to connect between devices must be 4 m or less. The total length of connecting cables in a single GPIB system must be $2 \text{ m} \times$ the number of connected devices (including the controller) or less. You cannot construct the system in which the total cable length exceeds 20 m.
- The number of connectors connected to an individual device must be 4 or less. If you connect 5 or more connectors, excessive force is applied to the connector part, which may result in failure.

- You can choose the device connection topology from star, linear, and combined. Loop connection is not supported.

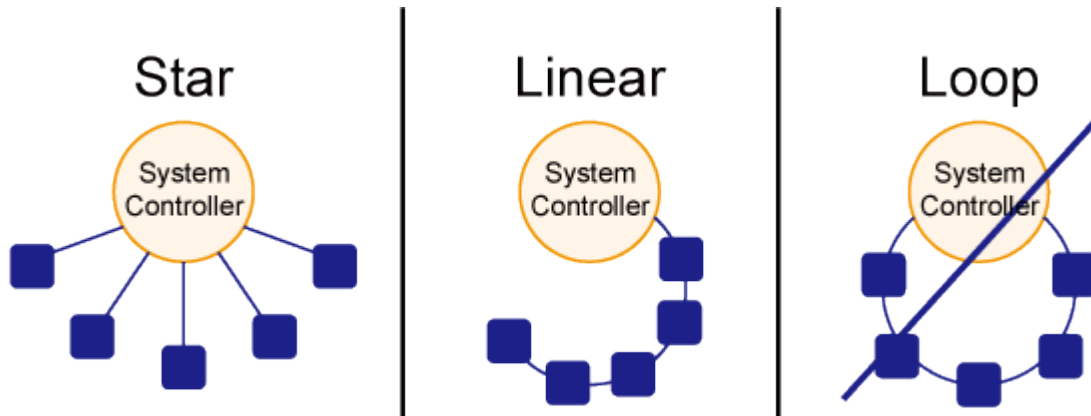

e5071c305

Device selector

The device selector is a unique value assigned to each device that is used by the controller to select the control target (to send/receive messages) among devices connected on the GPIB remote control system.

The device selector consists of a select code (usually, 7) and a GPIB address. For example, when the select code is 7 and the GPIB address is 17, the device selector is 717. The select code must be set for each system. The GPIB address must be set to a unique value for each device, which is used to identify devices on the same system. In the description and sample programs in this manual, it is assumed that the device selector is set to 717.

Setting the GPIB address of E4990A

To set the GPIB address for talker/listener mode, See [Setting talker/listener GPIB address of E4990A](#).

LAN remote control system

- [Overview](#)
- [System Configuration](#)
- [Required Equipment](#)
- [Control over SICL-LAN Server](#)
- [Control with Telnet Server](#)
- [About LXI](#)

[Other topics about Overview](#)

E4990A Impedance Analyzer Help

Overview

The LAN (Local Area Network) remote control system provides two methods: controlling the E4990A using the SICL-LAN server and controlling the E4990A using the telnet server.

System Configuration

Use a LAN cable to connect between the E4990A and the external controller (computer). The following figure shows the overview of the system configuration of the LAN remote control system.

Configuration of the LAN remote control system

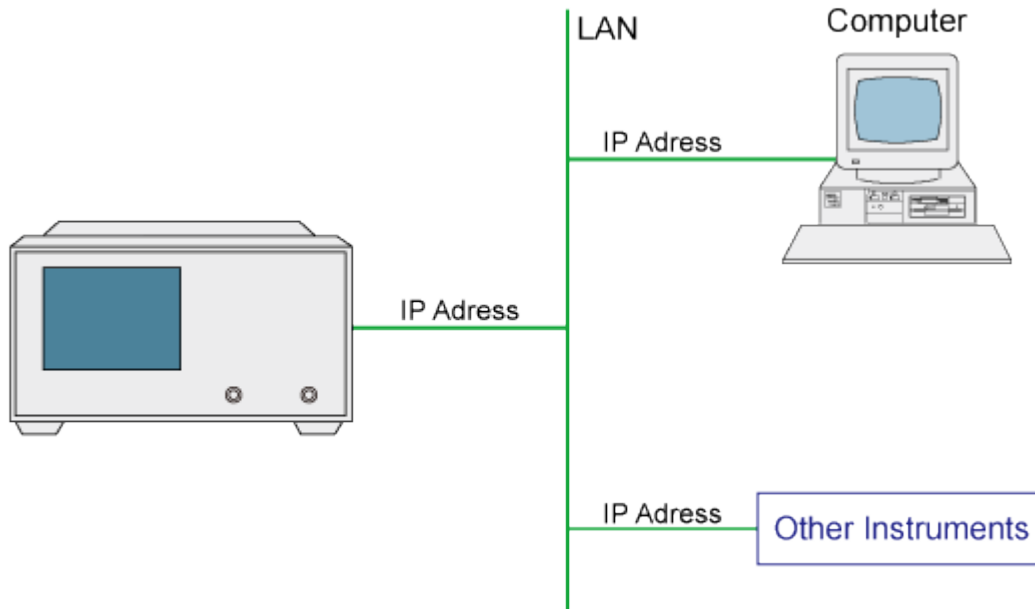

e5061b055

Required Equipment

- E4990A
- External controller (PC or workstation that can be connected to LAN)
- Other devices (other instruments and/or peripherals that serve your purpose)
- LAN cables

Control over SICL-LAN Server

In the control system using the SICL-LAN server, communication between the external controller (client) and the E4990A (server) is performed using the SICL-LAN protocol. Communication is performed using SICL (Standard Instrument Control Library). You can control the E4990A by programming using SICL or VISA with the C language in the UNIX environment, or Visual C++, Visual Basic, or VEE in the Windows environment.

Preparing the E4990A

To communicate with the external controller, follow these steps to turn ON the SICL-LAN server of the E4990A in advance.

1. To activate the SICL-LAN Server of the E4990A.

System > Misc Setup > Network Setup > Enable [ON]

Preparing the external controller

In order to establish communication with/ the E4990A using the TCP/IP protocol, you need to set the I/O interface of the external controller in advance. This section shows the setting procedure when using the external controller in the Windows environment.

NOTE

You must install the Keysight I/O Libraries on your PC in advance.

1. From your PC's Start menu, click **Program > Keysight I/O Libraries Suite > Keysight Connection Expert** to open the Keysight Connection Expert setting screen.
2. In the Keysight Connection Expert setting screen, select **LAN(TCPIP0)** in the **Instrument I/O on this PC** frame, and then click **I/O Configuration > Add Instrument**.
3. In the Add LAN Instrument Properties screen, set up the IP address of the E4990A and click **OK**. You can change settings as necessary. For details, refer to the Keysight I/O Libraries Suite documentation.

E4990A Impedance Analyzer Help

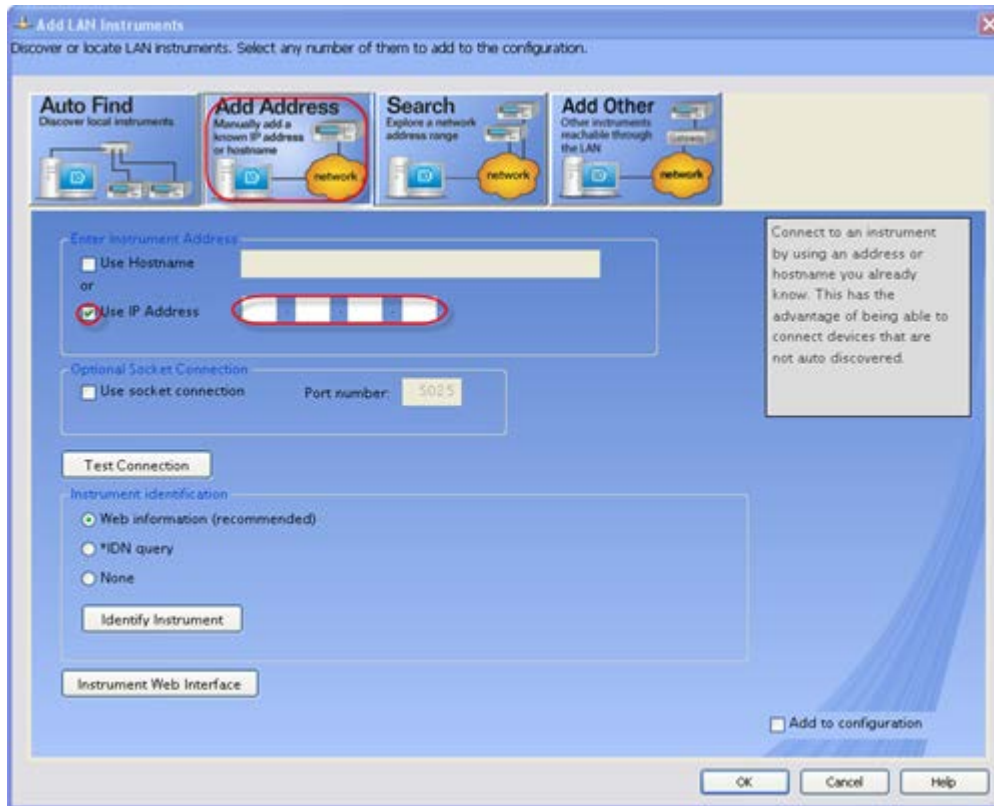

4. In the Keysight Connection Expert screen, check that the E4990A has been added under LAN(TCPIP0) in the Instrument I/O on this PC frame.

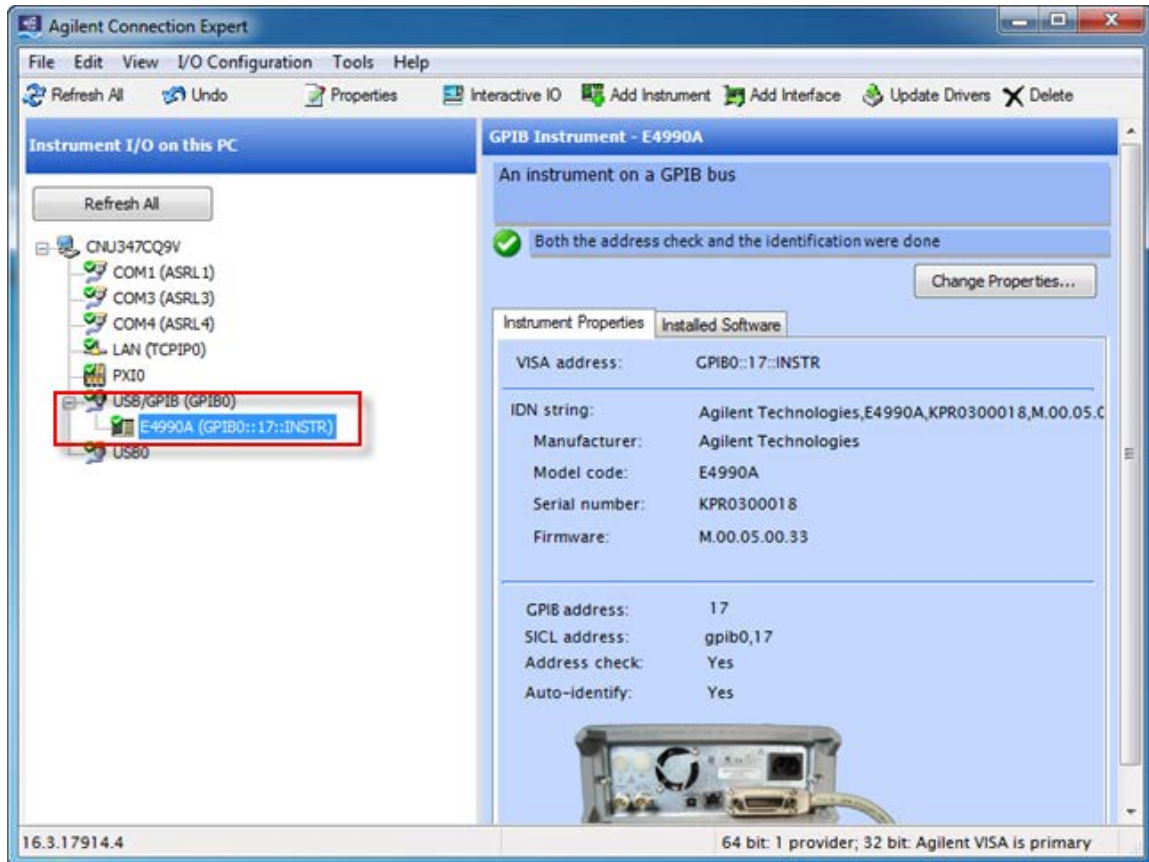

5. The Instrument manager displays the connection with E4990A.

Control with Telnet Server

In the control system over telnet server, communications are performed through connection between the sockets provided by the processes of the external controller and the E4990A to establish a network path between them.

A socket is an endpoint for network connection; port 5024 and port 5025 are provided for the sockets for the E4990A. Port 5024 is provided for conversational control using telnet (user interface program for the TELNET protocol) and port 5025 for control from a program.

NOTE To use telnet, port 5024 and 5025 should be opened through [Windows firewall](#).

Preparing the E4990A

To communicate with the external controller, follow these steps to turn on the telnet server of the E4990A in advance.

System > Misc Setup > Network Setup > Enable [ON]

NOTE When the telnet server is turned ON for the first time, the windows firewall setting dialog box appears. Select **Unblock** and click

E4990A Impedance Analyzer Help

OK. If you select **Keep Blocking** on firewall setting, you need to unblock for the remote server in Windows firewall to use the telnet server.

Conversational control using telnet (using port 5024)

You can use telnet to perform conversational control by sending SCPI commands to the E4990A on a message-by-message basis. For telnet, the socket of port 5024 is used for communications.

In this example, in order to show you the control procedure using telnet, you control the E4990A (IP address: 192.168.0.2 and host name: E4990A) from the external controller in the Windows environment.

1. Open the MS-DOS command prompt screen.
2. At the MS-DOS prompt, type **telnet 192.168.0.2 5024** and press the return key.
3. The telnet screen opens.
4. Type a command and press the return key; it is sent to the E4990A and executed. If you enter a command that queries some data, the query response is displayed below the line you have entered the command.
5. The following figure shows the screen after using the **:SYST:PRES** command to reset, the **:SENS1:FREQ:STAR** command and **:SENS1:FREQ:STOP** commands to set the sweep start value and stop value to 1 GHz and 2 GHz respectively, and checking the settings.

Example of control using telnet

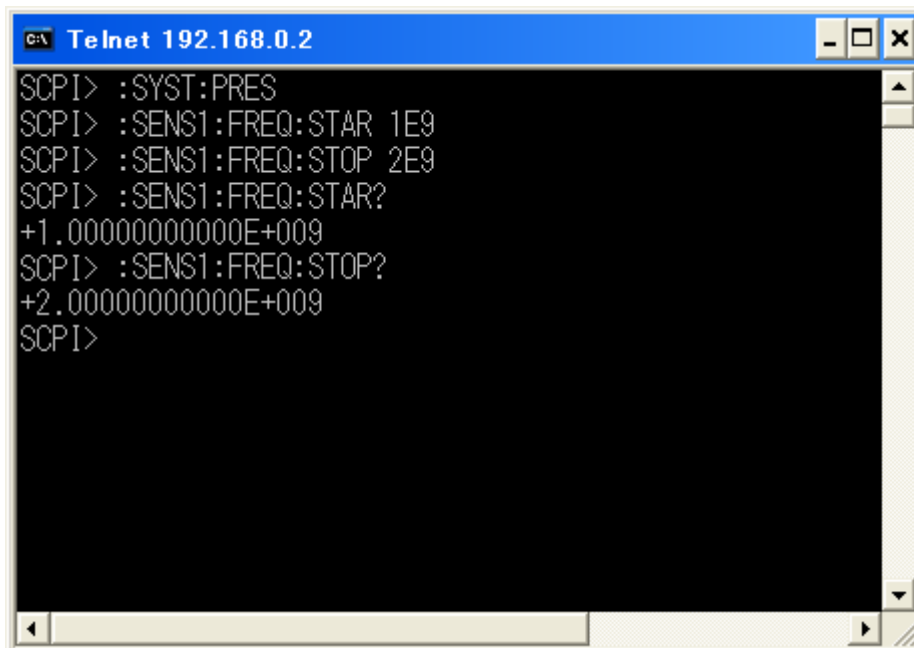

```
GA Telnet 192.168.0.2
SCPI> :SYST:PRES
SCPI> :SENS1:FREQ:STAR 1E9
SCPI> :SENS1:FREQ:STOP 2E9
SCPI> :SENS1:FREQ:STAR?
+1.000000000000E+009
SCPI> :SENS1:FREQ:STOP?
+2.000000000000E+009
SCPI>
```

6. Press] while holding down Ctl in the telnet screen to break the connection with the E4990A. The telnet prompt appears. At the telnet prompt, type quit and press the Enter key. The connection to the E4990A breaks and telnet ends.

Control from a program (using port 5025)

When controlling the E4990A from a program on the external controller, use the socket of port 5025 for connection. **System > Misc Setup > Network Setup > Enable [ON]**

NOTE It is not possible to turn on both Web server and Socket server.

NOTE Some functions such as service requests that are available in the GPIB remote control system are not available in control over telnet server.

About LXI

LXI (LAN eXtensions for Instrumentation) is the LAN-based successor to GPIB and combines the advantages of Ethernet with the simplicity and familiarity of GPIB. The key features of LXI are as follows:

- The speed, simplicity, worldwide reach, low cost, ongoing enhancement and backward compatibility of LAN.
- Quick, easy configuration through the intuitive web interface built into compliant instruments.
- Simplified programming and greater software reuse through IVI drivers.
- The ability to create hybrid systems that include LXI, GPIB, VXI, PXI, CANbus, etc.
- Enhanced system performance and event handling via hardware- and LAN-based triggering modes.
- Synchronization of local and remote instruments through the IEEE 1588 precision time protocol.
- For more information on LXI, refer to www.lxistandard.org

USB Remote Control System

- [Overview](#)
- [System Configuration](#)

[Other topics about Overview](#)

Overview

The USB (Universal Serial Bus) remote control system provides device control via USB, which is equivalent to control via GPIB. Connection is

E4990A Impedance Analyzer Help

made through an interface in compliance with USBTMC-USB488 and USB 2.0.

System Configuration

The USB remote control system controls instrument with either the name "alias" or the USB address.

Use a USB cable to connect the E4990A to an external controller (personal computer). The following figure shows an overview of the system configuration for the USB remote control system.

USB Remote Control System Configuration

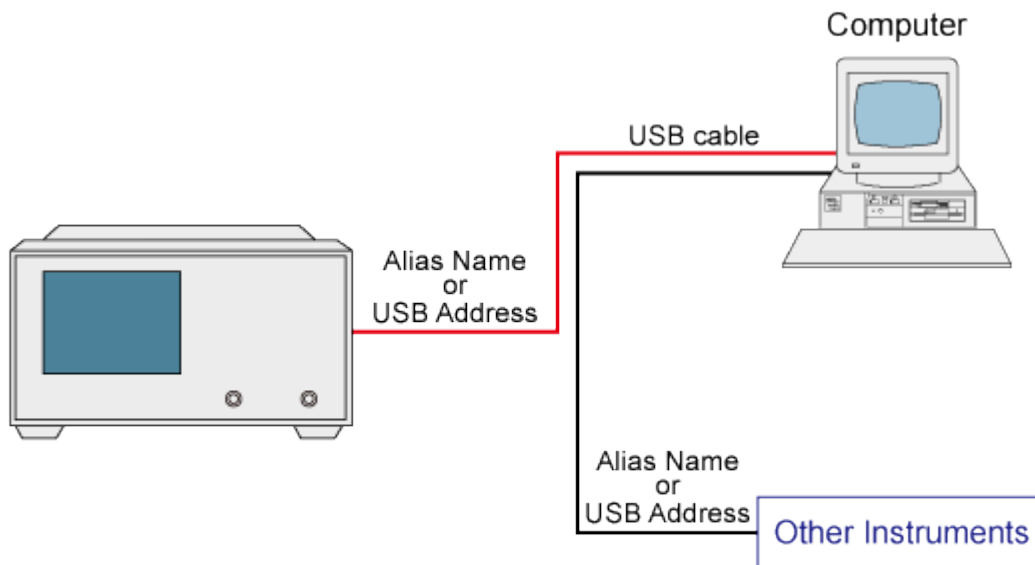

e5061b056



Required Equipment

- E4990A
- External controller (PC with USB host port (type A)).
- Other USB compatible devices (instruments and/or peripherals for specific purposes).
- USB cable connecting E4990A and external controller (with type A/4-prong male or type B/4-prong male connectors depending on device used).

USB Port Types

There are two standard types of USB ports. The external controller (PC) must be connected via the USB host port (type A), while the E4990A and

other USB compatible devices must be connected via the USB interface port (type B).

Port type	Description
	Type A: USB host port
	Type B: USB (USBTMC) interface port

Preparing E4990A

You do not have to configure any softkey or command of the E4990A in order to control the E4990A from an external controller. Simply connect a USB cable to the USB interface port.

Driver Installation

1. You must install the Keysight I/O Libraries on your PC in advance.
2. Connect the E4990A with your PC via USB cable. The driver is installed automatically at the first time connection. It takes a few minutes.

Getting VISA/SICL address

1. From your PC's Start menu, click **Program > Keysight I/O Libraries Suite > Keysight Connection Expert** to open the **Keysight Connection Expert** setting screen.
2. Click **Refresh All**.
3. The E4990A appears under USB0.
4. Click it, then address information is displayed.

E4990A Impedance Analyzer Help

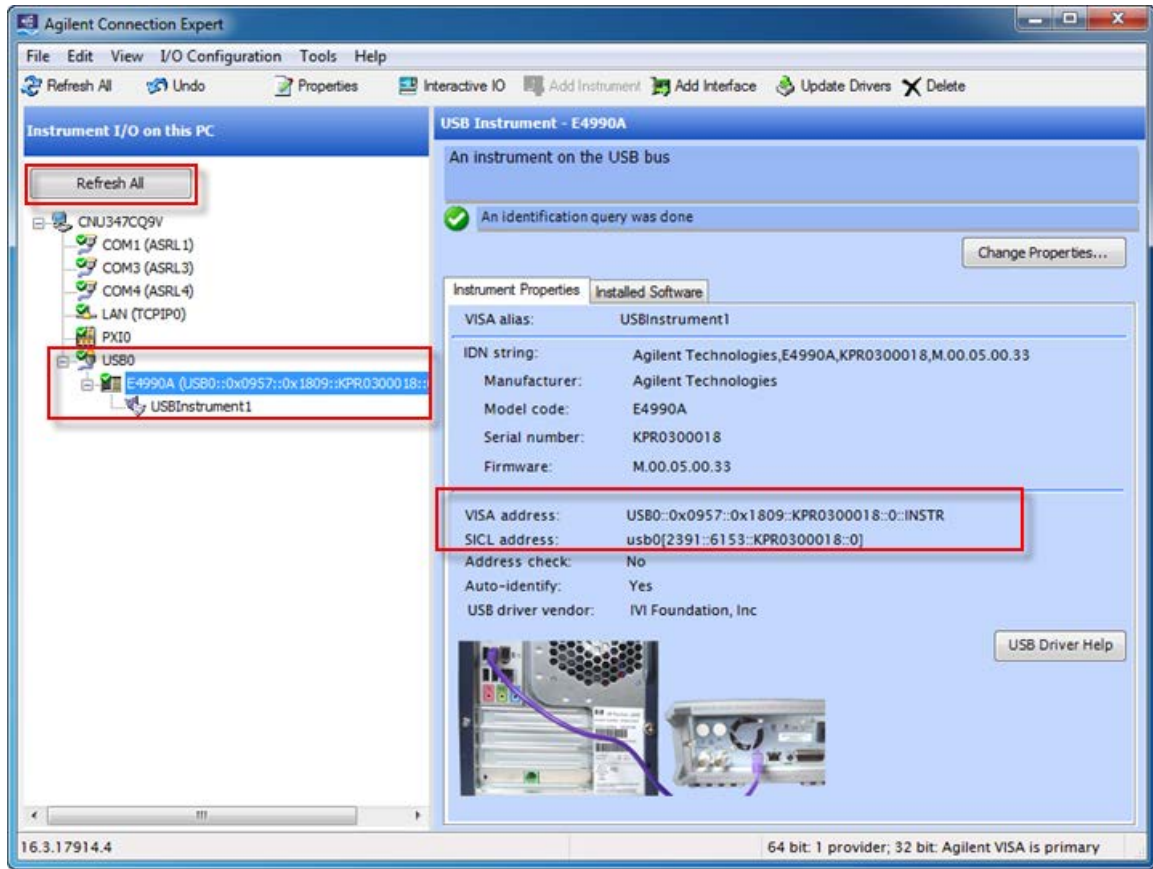

Sending SCPI command messages

- [Type and Structure of Commands](#)
- [Grammar of Messages](#)
- [Remote Mode](#)

[Other topics about Overview](#)

Type and Structure of Commands

The SCPI commands available for the E4990A are classified into 2 groups as follows.

E4990A commands

Commands specific to the E4990A. They cover all measurement functions that the E4990A has and some general-purpose functions. The commands in this group are arranged in a hierarchical structure called the command tree. Each command consists of character strings (mnemonics) indicating each hierarchical level and colon (:) separators between hierarchical levels.

IEEE common commands

Commands to cover general-purpose functions defined in IEEE488.2 that are available commonly to instruments that support this standard. The

commands in this group have an asterisk (*) at the beginning. For the commands in this group, there is no hierarchical structure.

Concepts of the command tree

The commands at the top of the command tree are called "root command" or simply "root." To access lower level commands in the tree, you need to specify a specific path like a directory path in the DOS file system. After power-on or reset, the current path is set to the root. Special characters in messages change the path setting as described below.

Message terminator

A message terminator such as the

<new line> character sets the current path to the root.

Colon (:)

A colon between 2 command mnemonics lowers the level of the current path in the command tree. A colon used as the first character of a command specifies the command mnemonic that follows as the root-level command.

Semicolon (;)

A semicolon does not change the current path and separates 2 commands in the same message.

The following figure shows an example of how to use colons and semicolons to efficiently access commands in the command tree.

Using colons and semicolons

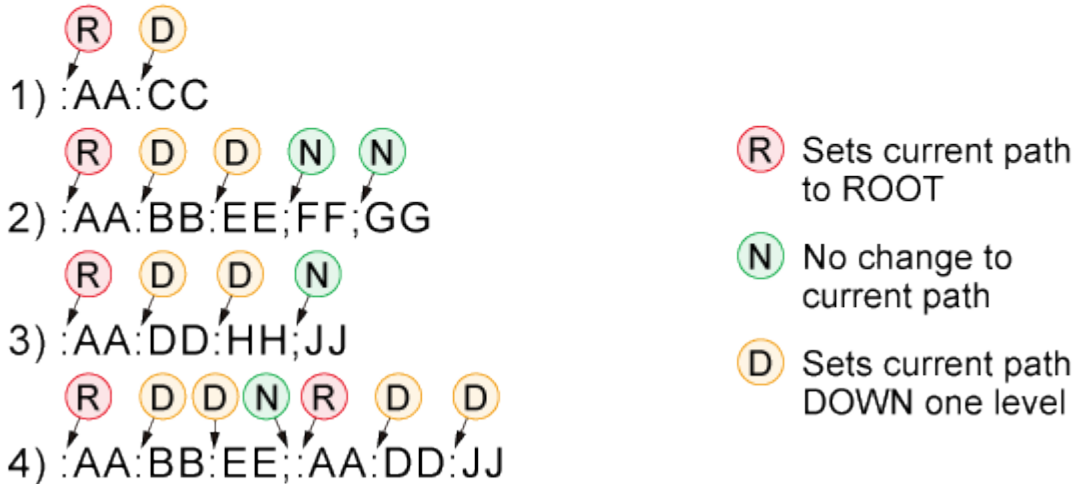
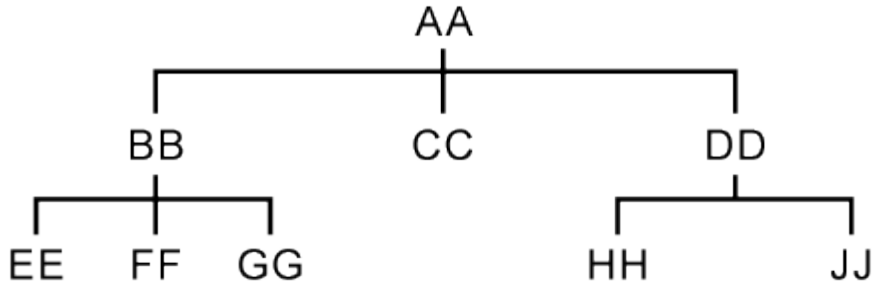

e5071c350

Grammar of Messages

This section describes the grammar to send program messages via GPIB. Program messages are messages that the user sends to the instrument from the external controller to control the instrument. A program message consists of 1 or more commands and their necessary parameters.

Upper/lower case sensitivity

Upper/lower case insensitive.

Program message terminator

A program message must be terminated with one of the 3 program message terminators: <new line>, <^END>, or <new line><^END>. <^END> indicates that EOI on the GPIB interface becomes active at the instant when the immediately previous data byte is sent. For example, the OUTPUT command of HTBasic automatically sends the message terminator after the last data byte.

Parameters

A space (ASCII code: 32) is required between a command and its first parameter. When sending several parameters in a single command, separate each parameter with a comma (,).

Message including several commands

When sending 2 or more commands in a single message, separate each command with a semicolon (;). The following example shows how to send the ***CLS** command and the **:SYST:PRES** command in a single message using VISA-COM.

```
Ana.WriteString "*CLS;:SYST:PRES", True
```

Remote Mode

The E4990A does not provide remote mode. Therefore, even if you send a GPIB command, it never enters into the remote mode automatically. There is no local key to release remote mode.

If you need to prevent misoperation during remote control due to entry from the front panel or mouse, lock the input devices using the following commands.

- **:SYST:KLOC:KBD**
- **:SYST:KLOC:MOUS**

Setting Measurement Condition

Setting Measurement Conditions

- [Setting up the Measurement](#)
- [Adapter Setting](#)

Setting up the Measurement

- [Overview](#)
- [Sample Program in Excel VBA](#)

[Other topics about Setting Measurement Conditions](#)

Overview

The program listed in the below section is written in VISA-COM with Excel VBA. It can be executed from the external PC controller. The program demonstrates how to set up the measurement conditions.

Setting up Measurement Conditions Sample Program in Excel VBA

```
Sub Setup()
```

```
'
```

```
'
```

```
' The memory area of the resource manager and the instrument I/O are acquired
```

E4990A Impedance Analyzer Help

```
Dim iomgr As VisaComLib.ResourceManager
Dim Analyzer As VisaComLib.FormattedIO488
```

```
Set iomgr = New VisaComLib.ResourceManager
Set Analyzer = New VisaComLib.FormattedIO488
```

```
' Open the instrument. Sets the GPIB address.
```

```
Set Analyzer.IO = iomgr.Open("USB0::0x0957::0x1809::KPR0200015::0::INSTR")
```

```
' TimeOut time should be greater than the measurement time.
```

```
Analyzer.IO.timeout = 10000
```

```
'
```

```
' Initial Setup
```

```
Analyzer.WriteString ":SYST:PRES", True
```

```
' Set two channel
```

```
Analyzer.WriteString ":DISP:SPL D1_2", True
```

```
' Set trigger source at BUS.
```

```
Analyzer.WriteString ":TRIG:SOUR BUS", True
```

```
'
```

```
' Setup Channel 1
```

```
' Set measurement parameter for trace 1
```

```
Analyzer.WriteString ":CALC1:PAR1:DEF Z", True
```

```
' Set measurement parameter for trace 2
```

```
Analyzer.WriteString ":CALC1:PAR2:DEF TZ", True
```

```
' Set Y-Axis at Log format
```

```
Analyzer.WriteString ":DISP:WIND1:TRAC1:Y:SPAC LOG", True
```

```
' Stimulus Setup
```

```
' Turn on Continuous Activation mode for channel 1
```

```
Analyzer.WriteString ":INIT1:CONT ON", True
```

```
' Set sweep type at LOG
```

```
Analyzer.WriteString ":SENS1:SWE:TYPE LOG", True
```

```
' Set number of point
```

```
Analyzer.WriteString ":SENS1:SWE:POIN 201", True
```

```
' Set start frequency
```

```
Analyzer.WriteString ":SENS1:FREQ:STAR 100E3", True
```

```
' Set stop frequency
```

```
Analyzer.WriteString ":SENS1:FREQ:STOP 10E6", True
```

```

' Set OSC mode
Analyzer.WriteString ":SOUR1:MODE VOLT", True
' Set OSC level
Analyzer.WriteString ":SOUR1:VOLT 300E-3", True
' Turn on ALC
Analyzer.WriteString ":SOUR1:ALC ON", True
'
' Setup Channel 2
' Set measurement parameter for trace 1
Analyzer.WriteString ":CALC2:PAR1:DEF CS", True
' Set measurement parameter for trace 2
Analyzer.WriteString ":CALC2:PAR2:DEF Q", True
' Split the trace windows
Analyzer.WriteString ":DISP:WIND2:SPL D1_2", True

' Stimulus Setup
' Turn on Continuous Activation mode for channel 1
Analyzer.WriteString ":INIT2:CONT ON", True
' Set sweep type at segment sweep
Analyzer.WriteString ":SENS2:SWE:TYPE SEGM", True
' Set segment display at freq base
Analyzer.WriteString ":DISP:WIND2:X:SPAC LIN", True
SegFmt = "7,0,1,0,0,0,0,3,"
SegNo1 = "1E4,1E5,50,0,0.3," ' Start Freq, Stop Freq, Nop, Voltage Type, OSC level
SegNo2 = "1E5,1E6,200,0,0.5,"
segNo3 = "1E6,1E7,50,0,0.3"
' Set sweep type at LOG"
Analyzer.WriteString ":SENS2:SEGM:DATA " & SegFmt & SegNo1 & SegNo2 & segNo3, True
'
' Save setting into state file
' Save settings to file
Analyzer.WriteString ":MMEM:STOR ""D:\State\Test.sta""", True

' Close IO
Analyzer.IO.Close

```

End Sub

Adapter Setting

- [Overview](#)
- [Sample Program in Excel VBA](#)

[Other topics about Setting Measurement Conditions](#)

Overview

The program listed in the below section is written in VISA-COM with Excel VBA. It can be executed from the external PC controller. The program demonstrates how to perform the adapter settings.

Adapter Setting Sample Program in Excel VBA

```
Sub AdapterSetup()  
,  
,  
  
'The memory area of the resource manager and the instrument I/O are acquired  
Dim iomgr As VisaComLib.ResourceManager  
Dim Analyzer As VisaComLib.FormattedIO488  
Dim Dmy As Integer  
  
Set iomgr = New VisaComLib.ResourceManager  
Set Analyzer = New VisaComLib.FormattedIO488  
  
' Open the instrument. Set the GPIB address.  
Set Analyzer.IO = iomgr.Open("USB0::0x0957::0x1809::KPR0200015::0::INSTR")  
' TimeOut time should be greater than the measurement time.  
Analyzer.IO.timeout = 50000  
  
' Select the adapter  
' Set adapter type to 42942A  
Analyzer.WriteString ":SENS1:ADAP:TYPE E4PR", True  
  
' Phase setup  
MsgBox "Connect Open Termination"  
' Execute open in phase setup  
Analyzer.WriteString ":SENS1:ADAP:CORR:COLL:ACQ PHAS", True  
' Wait for measurement end  
Analyzer.WriteString "**OPC?", True  
Dmy = Analyzer.ReadNumber  
' Save phase setup data
```

```
Analyzer.WriteString ":SENS1:ADAP:CORR:COLL:SAVE PHAS", True
MsgBox "Phase Setup Done"
```

```
' Impedance setup
MsgBox "Connect Open Termination"
' Execute open in impedance setup
Analyzer.WriteString ":SENS1:ADAP:CORR:COLL:ACQ OPEN", True
' Wait for measurement end
Analyzer.WriteString "**OPC?", True
Dmy = Analyzer.ReadNumber
MsgBox "Connect Short Termination"
' Execute short in impedance setup
Analyzer.WriteString ":SENS1:ADAP:CORR:COLL:ACQ SHOR", True
' Wait for measurement end
Analyzer.WriteString "**OPC?", True
Dmy = Analyzer.ReadNumber
MsgBox "Connect LOAD Termination"
' Execute load in impedance setup
Analyzer.WriteString ":SENS1:ADAP:CORR:COLL:ACQ LOAD", True
' Wait for measurement end
Analyzer.WriteString "**OPC?", True
Dmy = Analyzer.ReadNumber
' Save impedance setup data
Analyzer.WriteString ":SENS1:ADAP:CORR:COLL:SAVE IMP", True
MsgBox "Impedance Setup Done"

' Close IO
Analyzer.IO.Close
```

End Sub

Preparing for Accurate Measurement

Preparing for Accurate Measurement

- [User Calibration](#)
- [Fixture Compensation](#)

User Calibration

E4990A Impedance Analyzer Help

- [Overview](#)
- [Sample Program in Excel VBA](#)

[Other topics about Preparing for Accurate Measurement](#)

Overview

The program listed in the below section is written in VISA-COM with Excel VBA. It can be executed from the external PC controller. The program demonstrates how to perform user calibration.

User Calibration Sample Program in Excel VBA

```
Sub UserCal()  
    '  
    '  
    ' The memory area of the resource manager and the instrument I/O are acquired  
    Dim iomgr As VisaComLib.ResourceManager  
    Dim Analyzer As VisaComLib.FormattedIO488  
    Dim Dmy As Integer  
  
    Set iomgr = New VisaComLib.ResourceManager  
    Set Analyzer = New VisaComLib.FormattedIO488  
  
    ' Open the instrument. Set the GPIB address.  
    Set Analyzer.IO = iomgr.Open("GPIB0::17::INSTR")  
  
    ' TimeOut time should be greater than the measurement time.  
    Analyzer.IO.timeout = 50000  
  
    ' Select adapter  
    ' Set compensation point at fix  
    Analyzer.WriteString ":SENS1:CORR:COLL:FPO FIX", True  
    ' Impedance setup  
    MsgBox "Connect Open Termination"  
    ' Execute open in user calibration  
    Analyzer.WriteString ":SENS1:CORR1:COLL:ACQ:OPEN", True  
    ' Wait for measurement to end  
    Analyzer.WriteString "*OPC?", True  
    Dmy = Analyzer.ReadNumber  
    MsgBox "Connect Short Termination"  
    ' Execute short in user calibration
```

```

Analyzer.WriteString ":SENS1:CORR1:COLL:ACQ:SHOR", True
' Wait for measurement to end
Analyzer.WriteString "**OPC?", True
Dmy = Analyzer.ReadNumber
MsgBox "Connect LOAD Termination"
' Execute load in user calibration
Analyzer.WriteString ":SENS1:CORR1:COLL:ACQ:LOAD", True
' Wait for measurement to end
Analyzer.WriteString "**OPC?", True
Dmy = Analyzer.ReadNumber
' Save impedance setup data
Analyzer.WriteString ":SENS1:CORR1:COLL:SAVE", True
MsgBox "Impedance Setup Done"

' Close IO
Analyzer.IO.Close

```

End Sub

Fixture Compensation

- [Overview](#)
- [Sample Program in Excel VBA](#)

[Other topics about Preparing for Accurate Measurement](#)

Overview

The program listed in the below section is written in VISA-COM with Excel VBA. It can be executed from the external PC controller. The program demonstrates how to perform fixture compensation.

Fixture Compensation Sample Program in Excel VBA

```

' The memory area of the resource manager and the instrument I/O are acquired
Dim iomgr As VisaComLib.ResourceManager
Dim Analyzer As VisaComLib.FormattedIO488

Sub FixtureCompen()
    Dim Dmy As Integer, Flg As Integer
    Set iomgr = New VisaComLib.ResourceManager
    Set Analyzer = New VisaComLib.FormattedIO488

    ' Open the instrument. Set the GPIB address.

```

E4990A Impedance Analyzer Help

```
Set Analyzer.IO = iomgr.Open("USB0::0x0957::0x1809::KPR0200015::0::INSTR")
```

```
' TimeOut time should be greater than the measurement time.
```

```
Analyzer.IO.timeout = 50000
```

```
' Select compensation point
```

```
' Set compensation point at fix
```

```
Analyzer.WriteString ":SENS1:CORR:COLL:FPO FIX", True
```

```
' Select fixture model
```

```
Analyzer.WriteString ":SENS1:FIXT:SEL FIXT16047A", True
```

```
'
```

```
Call DefineTermination
```

```
'
```

```
' Perform Fixture Compensation
```

```
Flg = MsgBox("Do you perform Open Fixture Compensation?", vbYesNo, "Fixture Compensation")
```

```
If Flg = vbYes Then
```

```
    MsgBox "Connect Open Termination"
```

```
    ' Execute open in fixture compensation
```

```
    Analyzer.WriteString ":SENS1:CORR2:COLL:ACQ:OPEN", True
```

```
    ' Wait for measurement end
```

```
    Analyzer.WriteString "**OPC?", True
```

```
    Dmy = Analyzer.ReadNumber
```

```
End If
```

```
Flg = MsgBox("Do you perform Short Fixture Compensation?", vbYesNo, "Fixture Compensation")
```

```
If Flg = vbYes Then
```

```
    MsgBox "Connect Short Termination"
```

```
    ' Execute short in fixture compensation
```

```
    Analyzer.WriteString ":SENS1:CORR2:COLL:ACQ:SHOR", True
```

```
    ' Wait for measurement end
```

```
    Analyzer.WriteString "**OPC?", True
```

```
    Dmy = Analyzer.ReadNumber
```

```
End If
```

```
Flg = MsgBox("Do you perform Load Fixture Compensation?", vbYesNo, "Fixture Compensation")
```

```
If Flg = vbYes Then
```

```
    MsgBox "Connect LOAD Termination"
```

```
    ' Execute load in fixture compensation
```

```

Analyzer.WriteString ":SENS1:CORR2:COLL:ACQ:LOAD", True
' Wait for measurement end
Analyzer.WriteString "*OPC?", True
Dmy = Analyzer.ReadNumber
End If

' Close IO
Analyzer.IO.Close

End Sub

Sub DefineTermination()
'
Dim LoadF() As String, n As Integer, i As Integer
' Define Short termination by equivalent circuit model
' Set equivalent circuit model for short
Analyzer.WriteString ":SENS1:CORR2:CKIT:SHOR:MOD EQU", True
' Set short termination parameter (L)
Analyzer.WriteString ":SENS1:CORR2:CKIT:SHOR:L 1E-9", True
' Set short termination parameter (R)
Analyzer.WriteString ":SENS1:CORR2:CKIT:SHOR:R 1E-4", True
'
' Define Load by f-Z table model
' Set f-Z table model for short
Analyzer.WriteString ":SENS1:CORR2:CKIT:LOAD:MOD TABL", True
n = 4
ReDim LoadF(n)
' Define f-Z table (freq, real, imaginary)
LoadF(1) = "20, 49.5, 1E-3"
LoadF(2) = "1E3, 49.9, 1.2E-3"
LoadF(3) = "1E6, 50, 1.5E-3"
LoadF(4) = "120E6, 50.9, 2E-3"
' :SENS1:CORR2:CKIT:LOAD:TABL {n}, {freq 1}, {real 1}, {imaginary 1}, ... , {freq n}, {real n},
{imaginary n}
Analyzer.WriteString ":SENS1:CORR2:CKIT:LOAD:TABL " & Str(n) & ", ", False ' Set f-Z table
For i = 1 To n - 1
    Analyzer.WriteString LoadF(i) & ", ", False

```

E4990A Impedance Analyzer Help

Next i

Analyzer.WriteString LoadF(n), True

End Sub

Starting a Measurement (Trigger) and Detecting the Completion of a Measurement

Starting a Measurement (Trigger) and Detecting the Completion of a Measurement

- [Trigger System](#)
- [Starting a Measurement Cycle](#)
- [Waiting for the End of Measurement](#)
- [Detecting Occurrence of an Error](#)

Trigger System

- [Overview](#)
- [System-Wide States and Transitions](#)
- [Channel-Wide States and Transitions](#)

[Other topics about Starting a Measurement \(Trigger\) and Detecting the Completion](#)

Overview

The trigger system is responsible for such tasks as detecting the start of a measurement cycle (triggering) and enabling/disabling measurement on each channel. As shown in the following figure, the trigger system has two types of states: system-wide and channel-wide. The system-wide state can be "Hold", "Waiting for Trigger", or "Measurement", while the channel-wide state can be "Idle" or "Initiate".

Trigger system

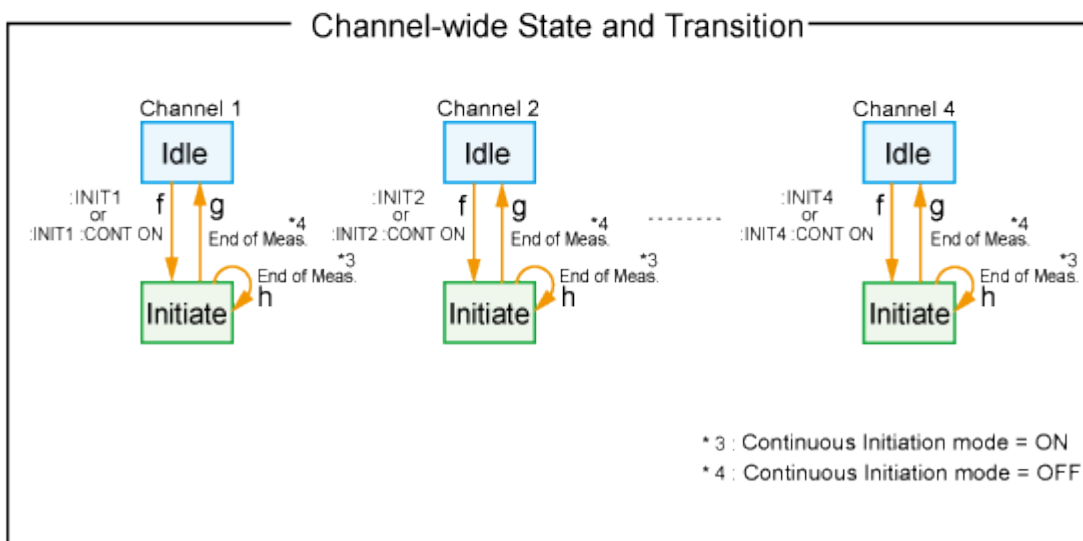
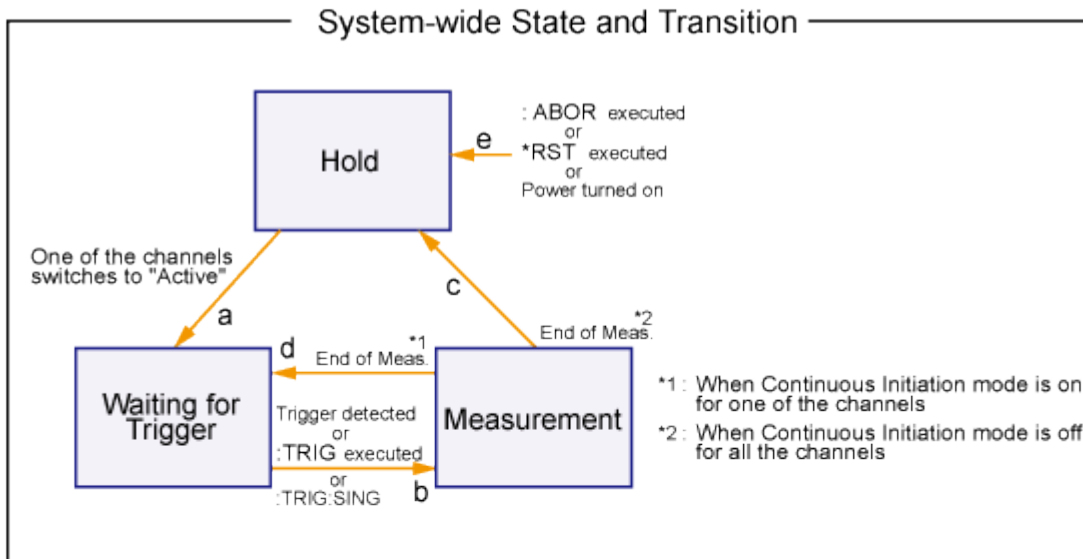

e5061b023

The following subsections describe each state and explains how the trigger system switches among the states.

System-Wide States and Transitions

"Hold" State

The trigger system switches to "Hold" state when one of the following commands is executed (arrow "e" in [Trigger system](#)). Also, turning ON the power to the instrument puts the trigger system into "Hold" state. When the power is turned ON, the continuous initiation mode is ON for channel 1 and the trigger source is set to "Internal". Accordingly, the trigger system immediately switches to "Waiting for Trigger" state and subsequently repeats transitions between "Measurement" and "Waiting for Trigger" states.

E4990A Impedance Analyzer Help

- :ABOR
- *RST

When the trigger system is in "Hold" state and one of the channels switches to "Initiate" state (arrow "f" in [Trigger system](#)), the trigger system switches to "Waiting for Trigger" state (arrow "a" in [Trigger system](#)).

"Waiting for Trigger" State

When the trigger system is in "Waiting for Trigger" state and either the instrument is triggered (i.e., a trigger is detected) or one of the following commands is executed, the trigger system switches to "Measurement" state (arrow "b" in [Trigger system](#))

- :TRIG
- :TRIG:SING
- *TRG

As shown in the table below, the instrument is triggered differently depending on which trigger source is specified. To specify the trigger source, use the :TRIG:SOUR command.

Trigger Source	How instrument is triggered
Internal trigger	The instrument is automatically triggered within itself
External trigger	The instrument is triggered when a trigger signal is input through the Ext Trig terminal or the handler interface
Bus trigger	The instrument is triggered when the trigger command is issued.
Manual trigger	The instrument is triggered when you press Trigger > Trigger on the front panel.

"Measurement" State

In "Measurement" state, the instrument waits for the elapse of the sweep delay time (set by the :SENS<ch>:SWE:DEL) and then starts a measurement cycle. This process is performed sequentially on each of those channels that are in "Initiate" state immediately before the transition to this state, in ascending order of channel number.

When the instrument has finished measuring all the active channels, the trigger system behaves in one of the following ways depending on the setting of the continuous initiation mode.

If continuous initiation mode is OFF for all channels:

The trigger system switches to "Hold" state (arrow "c" in [Trigger system](#)).

If continuous initiation mode is ON for one of the channels:

The trigger system switches to "Waiting for Trigger" state (arrow "d" in [Trigger system](#)).

Channel-Wide States and Transitions

"Idle" State

A channel switches to "Initiate" state when one of the following commands is executed (arrow "f" in [Trigger system](#)).

- `:INIT<ch>`
- `:INIT<ch>:CONT` ("ON" specified)

"Initiate" State

A channel in this state is measured just before the entire system switches to "Measurement" state.

When the instrument has finished measuring a channel, the channel behaves in one of the following ways depending on the setting of the continuous initiation mode (set by the `INIT<ch>:CONT`).

If continuous initiation mode is OFF: The channel switches to "Idle" state (arrow "g" in [Trigger system](#)).

If continuous initiation mode is ON: The channel remains in "Initiate" state (arrow "h" in [Trigger system](#)).

Starting a Measurement Cycle (Triggering the Instrument)

- [Configuring the Instrument](#)
- [Starting Measurement on Demand](#)

[Other topics about Starting a Measurement \(Trigger\) and Detecting the Completion](#)

Configuring the Instrument

1. Use the `:INIT<ch>:CONT` command to turn ON the continuous initiation mode for the channels you want to measure and turn the mode OFF for any other channel.
2. Issue the `:TRIG:SOUR` command to set the trigger source to Internal trigger.

Starting Measurement on Demand

E4990A Impedance Analyzer Help

1. Use the `:INIT<ch>:CONT` command to turn ON the continuous initiation mode for the channels you want to measure and turn the mode OFF for any other channel.
2. Issue the `:TRIG:SOUR` command to set the trigger source to "Bus Trigger".
3. Trigger the instrument whenever you want to perform the measurement. An external controller can trigger the instrument by using one of the following three commands:

Command	Can *OPC? command be used to wait for end of sweep?	Applicable trigger source
*TRG	No	Bus trigger only
:TRG		External trigger Bus trigger
:TRG:SING	Yes	Manual trigger

4. Repeat step 3 to start the next measurement cycle.

Waiting for the End of Measurement

- [Overview](#)
- [Sample Program in Excel VBA](#)

[Other topics about Starting a Measurement \(Trigger\) and Detecting the Completion](#)

Overview

The program listed in the below section is written in VISA-COM with Excel VBA. It can be executed from the external PC controller. The program demonstrates how to perform waiting for the end of measurement.

[Waiting for the End of Measurement Sample Program in Excel VBA](#)

Option Explicit

Implements VisaComLib.IEventHandler

```
' The variables of the resource manager
```

```
Dim ioMgr As VisaComLib.ResourceManager
```

```
Dim Ana As VisaComLib.FormattedIO488
```

```
Dim SRQ As VisaComLib.IEventManager
```

```

Sub IEventHandler_HandleEvent( _
    ByVal Ana As VisaComLib.IEventManager, _
    ByVal SRQevent As VisaComLib.IEvent, _
    ByVal userHandle As Long)
    ' Once the SRQ is detected, then get the data
    Call ReadData
End Sub

```

```

Sub UserForm_Initialize()

```

```

    ' Instrument I/O declaration

```

```

    Set ioMgr = New VisaComLib.ResourceManager

```

```

    Set Ana = New VisaComLib.FormattedIO488

```

```

    ' Open the instrument. Set the GPIB address

```

```

    ' You can change VISA address

```

```

    Set Ana.IO = ioMgr.Open("GPIB0::17::INSTR")

```

```

    ' TimeOut time should be greater than the measurement time.

```

```

    Ana.IO.timeout = 100000

```

```

    ' SRQ declaration

```

```

    Set SRQ = Ana.IO

```

```

    SRQ.InstallHandler EVENT_SERVICE_REQ, Me

```

```

    SRQ.EnableEvent EVENT_SERVICE_REQ, EVENT_HNDLR

```

```

    ' Clears the operation status event register and the status byte register.

```

```

    Ana.WriteString "*CLS", True

```

```

    ' Aborts the trigger and sets the trigger source to the bus trigger.

```

```

    Ana.WriteString ":TRIG:SOUR BUS", True

```

```

    Ana.WriteString ":INIT:CONT ON", True

```

```

    Ana.WriteString ":ABOR", True

```

```

    ' Sets the positive transition filter to 0 and the negative transition filter to 1 so that the operation status
    event register at bit 4 is set to 1 only when the

```

```

    ' operation status condition register at bit 4 is changed from 1 to 0.

```

```

    Ana.WriteString ":STAT:OPER:PTR 0", True

```

E4990A Impedance Analyzer Help

```
Ana.WriteString ":STAT:OPER:NTR 16", True
```

```
' Enables bit 4 in the operation status event register and bit 8 in the status byte register.
```

```
Ana.WriteString ":STAT:OPER:ENAB 16", True
```

```
Ana.WriteString "*SRE 128", True
```

```
End Sub
```

```
Sub CmdTrigger_Click()
```

```
' Making a trigger
```

```
Ana.WriteString ":TRIG", True
```

```
End Sub
```

```
Sub ReadData()
```

```
' Clear the status register
```

```
Ana.WriteString "*CLS", True
```

```
Dim MeasData As Variant, i As Integer
```

```
Range("A5:B500").Clear
```

```
' Get the measurement data.
```

```
Ana.WriteString ":CALC1:DATA:FDAT?", True
```

```
MeasData = Ana.ReadList(ASCIIType_R8, ",")
```

```
' Display the data on the sheet
```

```
ActiveSheet.Cells(6, 1) = "Data (Primary)"
```

```
ActiveSheet.Cells(6, 2) = "Data (Secondary)"
```

```
For i = 1 To UBound(MeasData)
```

```
    ActiveSheet.Cells(i + 6, 1).Value = MeasData(i * 2 - 2)
```

```
    ActiveSheet.Cells(i + 6, 2).Value = MeasData(i * 2 - 1)
```

```
Next i
```

```
End Sub
```

```
Sub CmdClose_Click()
```

```
' Close
```

```
Ana.IO.Close
```

```
Unload Me
```

```
End Sub
```

Detecting Occurrence of an Error

- [Overview](#)
- [Sample Program in Excel VBA](#)

[Other topics about Starting a Measurement \(Trigger\) and Detecting the Completion](#)

Overview

The program listed in the below section is written in VISA-COM with Excel VBA. It can be executed from the external PC controller. The program demonstrates how to detect occurrence of an error.

Detecting Occurrence of an Error Sample Program in Excel VBA

Option Explicit

Implements VisaComLib.IEventHandler

Dim ioMgr As VisaComLib.ResourceManager

Dim Ana As VisaComLib.FormattedIO488

Dim SRQ As VisaComLib.IEventManager

```
Private Sub IEventHandler_HandleEvent(ByVal Ana As VisaComLib.IEventManager, ByVal SRQevent
As VisaComLib.IEvent, ByVal userHandle As Long)
```

```
    Call readErr
```

```
End Sub
```

```
Private Sub UserForm_Initialize()
```

```
    ' The variables of the resource manager
```

```
    Set ioMgr = New VisaComLib.ResourceManager
```

```
    Set Ana = New VisaComLib.FormattedIO488
```

```
    Set Ana.IO = ioMgr.Open("GPIB0::17::INSTR")
```

```
    Set SRQ = Ana.IO
```

```
    SRQ.InstallHandler EVENT_SERVICE_REQ, Me, 1, 0
```

```
    SRQ.EnableEvent EVENT_SERVICE_REQ, EVENT_HNDLR
```

```
With Ana
```

```
    .WriteString "**RST"
```

```
    .WriteString "**ESE 60"
```

```
    .WriteString "**SRE 32"
```

```
    .WriteString "**CLS"
```

```
End With
```

```
End Sub
```

E4990A Impedance Analyzer Help

```
Private Sub CmdCorrect_Click()
```

```
With Ana
```

```
.WriteString "CALC1:PAR1:SEL"
```

```
.WriteString "SENS1:SWE:TYPE LIN"
```

```
End With
```

```
End Sub
```

```
Private Sub CmdIllegalPara_Click()
```

```
With Ana
```

```
.WriteString "CALC1:PAR1:SEL"
```

```
' "LINE" is incorrect parameter. hence, this causes an error.
```

```
.WriteString "SENS1:SWE:TYPE LINE"
```

```
End With
```

```
End Sub
```

'Detected error is read and showed on message box.

```
Private Sub readErr()
```

```
Dim readErr As Variant
```

```
Ana.WriteString "SYST:ERR?"
```

```
readErr = Ana.ReadList
```

```
Ana.WriteString "*CLS", True
```

```
MsgBox "Error : " & readErr(0) & " , " & readErr(1), vbOKOnly, "Error occurred."
```

```
End Sub
```

```
Private Sub EndBtn_Click()
```

```
Ana.IO.Close
```

```
Unload Me
```

```
End Sub
```

Reading Writing Measurement Data

Reading/Writing Measurement Data

- [Data Transfer Format](#)
- [Internal Data Processing](#)
- [Reading/Writing Data](#)

Data Transfer Format

- [Overview](#)
- [ASCII Transfer Format](#)
 - [Integer Format](#)
 - [Floating-Point Number Format](#)
- [Binary Transfer Format](#)

Other topics about Reading/Writing Measurement Data

Overview

When you transfer data using the one of the following commands, you can choose among ASCII transfer format, IEEE 64-bit floating point binary transfer format and IEEE 32-bit floating point binary transfer format.

The instrument always uses the ASCII transfer format when you transfer data without using any of the following commands:

- `:CALC<ch>:DATA:FDAT`
- `:CALC<ch>:DATA:FMEM`
- `:CALC<ch>:FUNC:DATA?`
- `:CALC<ch>:LIM:DATA`
- `:CALC<ch>:LIM:REP?`
- `:CALC<ch>:LIM:REP:ALL?`
- `:SENS<ch>:FREQ:DATA?`
- `:SENS<ch>:SEGM:DATA`

To set the data transfer format, use the following command:

`:FORM:DATA`

NOTE

Executing the `:SYST:PRES` or `*RST` does not affect the current setting of the data transfer format.

ASCII Transfer Format

When you select the ASCII transfer format as the data transfer format, numbers are transferred as ASCII bytes, each of which corresponds to one of the formats shown below. Note that numbers are separated from one another with a comma (,) in accordance with the IEEE 488.2 specification.

NOTE

Numeric data strings vary in length. Keep this in mind when you extract some data from retrieved numeric data strings in your program.

Integer Format

The figure below shows this format. Numbers are expressed as integers. For example, 201 is expressed as "+201" or "201."

Integer format

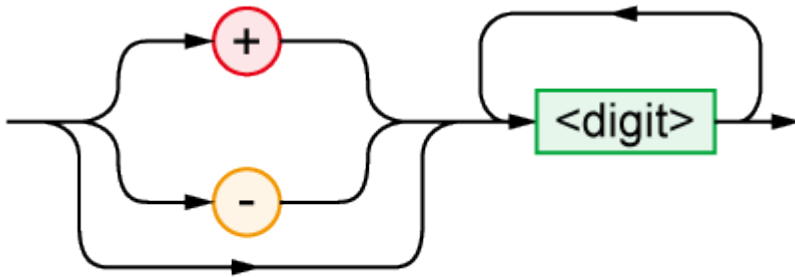

e5071c351

Floating-Point Number Format

The figure below shows this format. Numbers are expressed with floating points. The number of decimal is 12 at default. For example, 1000 is expressed as "+1.000000000000E+003."

Floating-point number format

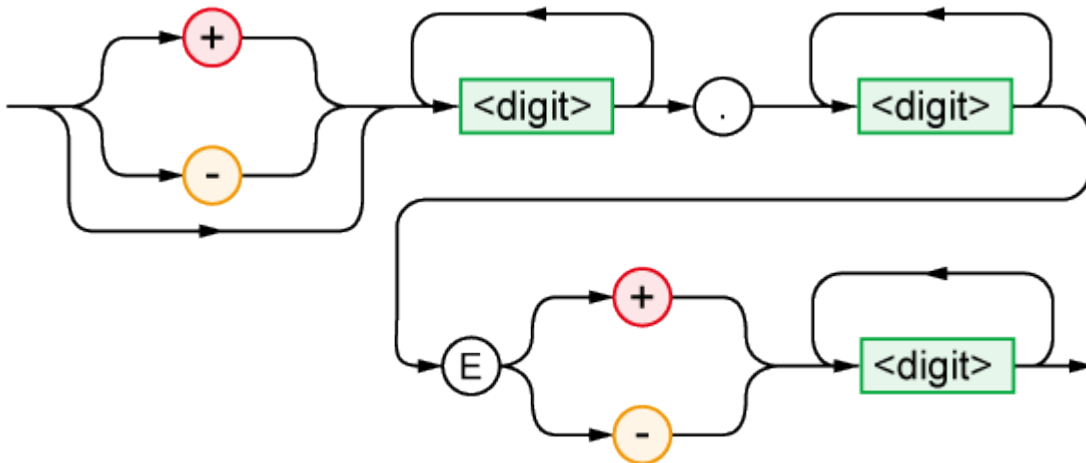

e5071c352

Binary Transfer Format

You can select the binary transfer format from the IEEE 64-bit floating point format or the IEEE 32-bit floating point format depending on the controller you use.

IEEE 64-bit floating point format

When you select the IEEE 64-bit floating point binary transfer format as the data transfer format, numbers are transferred in the format shown in the figure below.

Binary transfer format

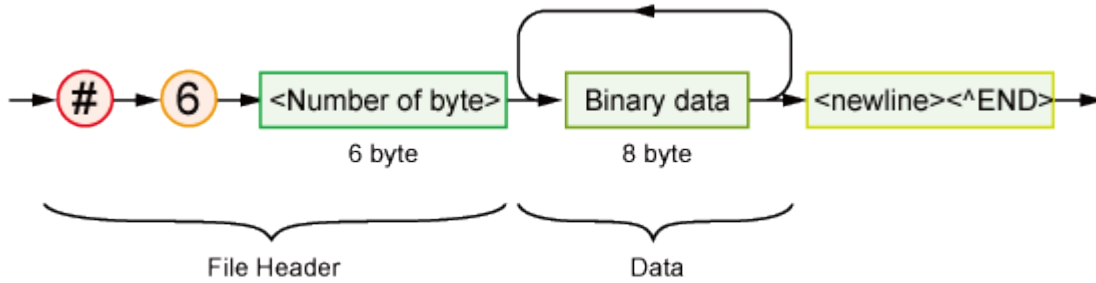

e5071c480

This data transfer format uses a header that consists of a sharp character (#), a number of 6 (which indicates the byte size of the <number of bytes transferred> part), and the <number of bytes transferred> part in this order. The header is followed by the binary data (each number consists of 8 bytes and the total is the byte size indicated by <number of bytes transferred>) and the message terminator <new line> ^END.

The binary data is expressed in the IEEE 754 64-bit floating-point number format shown in the figure below.

64-bit floating point format

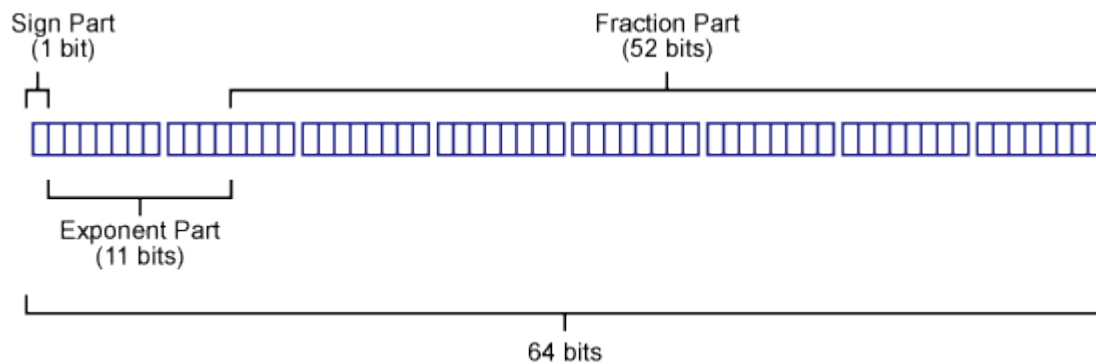

e5071c482

IEEE 32-bit floating point format

When you select the IEEE 32-bit floating point binary transfer format as the data transfer format, numbers are transferred in the format shown in the figure below.

IEEE 32-bit floating point binary transfer format

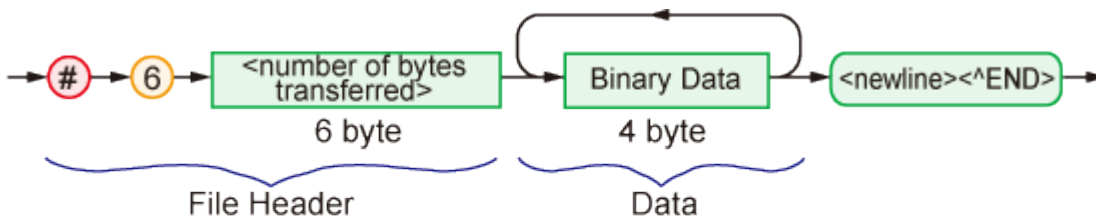

e5071c439

This data transfer format uses a header that consists of a sharp character (#), a number of 6 (which indicates the byte size of the <number of bytes transferred> part), and the <number of bytes transferred> part in this order. The header is followed by the binary data (each number consists of 4 bytes and the total is the byte size indicated by <number of bytes transferred>) and the message terminator <new line>^END.

The binary data is expressed in the IEEE 754 32-bit floating-point number format shown in the figure below.

32-bit floating point data

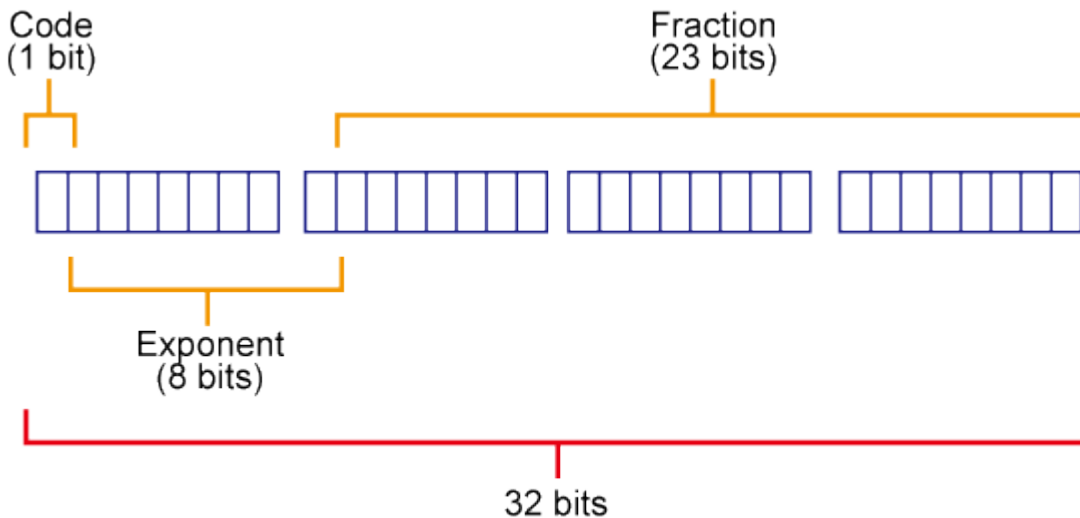

e5071c440

Byte order

When you opt to perform binary transfer, you can configure the instrument to transfer the bytes of the data in one of the following two byte orders:

NORMal

Transfer begins with the byte that contains the MSB (Most Significant Bit); that is, the leftmost byte in 64 bit floating point format and 32 bit floating point data.

SWAPped

Transfer begins with the byte that contains the LSB (Least Significant Bit); that is, the rightmost byte in 64 bit floating point format and 32 bit floating point data.

To set the byte order, use the following command:

:FORM:BORD

NOTE

Executing the `:SYST:PRES` or `*RST` does not affect the current setting of the byte order.

Internal Data Processing

- [Overview](#)
- [Internal Data Arrays](#)

Other topics about Communication with External Devices

Overview

The following figure provides an overview of the E4990A's internal data processing flow.

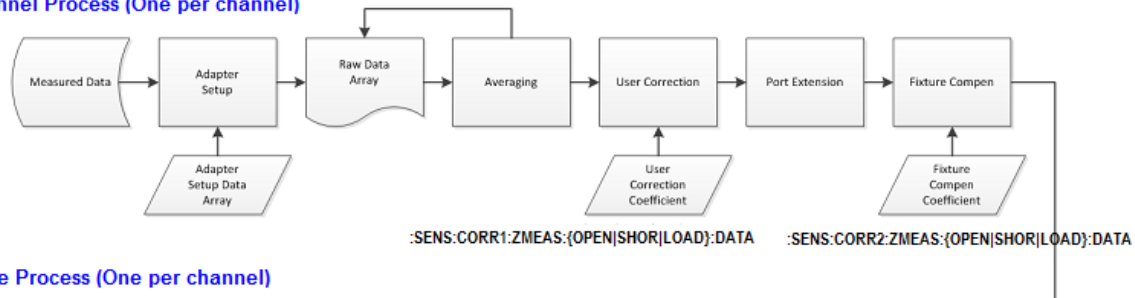
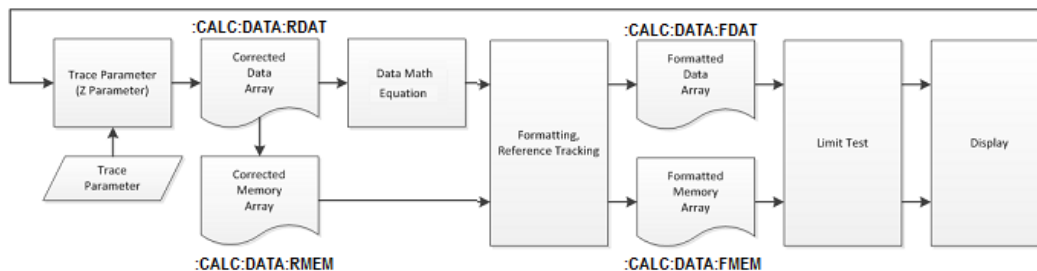
E4990A's data processing flow**Channel Process (One per channel)****Trace Process (One per channel)****Internal Data Arrays****Corrected data arrays**

A corrected data array contains the corrected data obtained by performing error correction and port extension compensation (calibration) operations on the raw measured data of S parameter specified for each trace of each channel. Each data element is stored as a complex number (Re/Im).

The instrument retains 16 corrected data arrays at maximum, each of which is associated with one of the 4 traces contained in one of the 4 channels ($4 \times 4 = 16$). To read/write one of the corrected data arrays, use the following command:

:CALC:DATA:RDAT

Corrected memory arrays

E4990A Impedance Analyzer Help

When the `:CALC:MATH:MEM` command is executed on a particular corrected data array, its copy is stored into the corrected memory array corresponding to that corrected data array.

The instrument retains 16 corrected memory arrays at maximum, each of which is associated with one of the 4 traces contained in one of the 4 channels ($4 \times 4 = 16$). To read/write one of the corrected data arrays, use the following command:

`:CALC:DATA:RMEM`

Formatted data array

A formatted data array contains the formatted data (values to be displayed) obtained by performing data math operations, measurement parameter conversion, and smoothing on a particular corrected data array. Regardless of the data format, it contains two data elements per measurement point as shown in the following table:

Data format	Data element (primary value)	Data element (secondary value)
log magnitude	log magnitude	Always 0
Phase	Phase	Always 0
Group delay	Group delay	Always 0
Polar (Lin)	Linear magnitude	Phase
Polar (Log)	Log magnitude	Phase
Polar (Re/Im)	Real part of a complex number	Imaginary part of a complex number
Linear magnitude	Linear magnitude	Always 0
SWR	SWR	Always 0
Real number	Real number	Always 0

Imaginary number	Imaginary part of a complex number	Always 0
Expanded phase	Expanded phase	Always 0
Positive phase	Positive phase	Always 0

The instrument retains 16 formatted data arrays at maximum, each of which is associated with one of the 4 traces contained in one of the 4 channels ($4 \times 4 = 16$). To read/write one of the formatted data arrays, use the following command:

[:CALC:DATA:FDAT](#)

Formatted memory arrays

A formatted memory array contains the formatted data (values to be displayed) obtained by performing data math operations, measurement parameter conversion, and smoothing on a particular corrected memory array.

The instrument retains 16 formatted memory arrays at maximum, each of which is associated with one of the 4 traces contained in one of the 4 channels ($4 \times 4 = 16$). To read/write one of the formatted memory arrays, use the following command:

[:CALC:DATA:FMEM](#)

Stimulus data arrays

A stimulus data array contains the stimulus values for all measurement points.

The instrument retains 4 stimulus data arrays at maximum, each of which is associated with one of the 4 channels. Stimulus data arrays are read-only. To retrieve one of the stimulus data arrays, use the following command:

[:SENS:FREQ:DATA?](#)

Reading/Writing Data

- [Overview](#)
- [Sample Program in Excel VBA](#)
 - [Reading Data](#)
 - [Writing Data](#)

[Other topics about Reading/Writing Measurement Data](#)

Overview

The program listed in the below section is written in VISA-COM with Excel VBA. It can be executed from the external PC controller. The program demonstrates how to read/write data.

[Reading/Writing Data Sample Program in Excel VBA](#)

Reading Data

```
Sub Read_Click()
```

```
Dim ReadData() As Double, FreqData() As Double
```

```
Dim Poin As Integer, DataType As String, TraceNo As String
```

```
**** The variables of the resource manager and the instrument I/O are declared.
```

```
Dim ioMgr As VisaComLib.ResourceManager
```

```
Dim Analyzer As VisaComLib.FormattedIO488
```

```
**** The memory area of the resource manager and the instrument I/O are acquired.
```

```
Set ioMgr = New VisaComLib.ResourceManager
```

```
Set Analyzer = New VisaComLib.FormattedIO488
```

```
**** Open the instrument.
```

```
Set Analyzer.IO = ioMgr.Open("GPIB0::17::INSTR")
```

```
Analyzer.IO.Timeout = 10000
```

```
**** Abort sweeping.
```

```
Analyzer.WriteString ":INIT1:CONT OFF", True
```

```
Analyzer.WriteString ":ABOR", True
```

```
**** Select trace
```

```
TraceNo = Cells(3, 2)
```

```
Analyzer.WriteString ":CALC1:PAR" & TraceNo & ":SEL", True
```

```
**** Get number of point of the stimulus data.
```

```
Analyzer.WriteString ":SENS1:SWE:POIN?", True
```

```
Poin = Analyzer.ReadNumber
```

```
ReDim FreqData(Poin - 1)
```

```
ReDim ReadData(Poin * 2 - 1)
```

```

DataType = Cells(5, 2)
Select Case DataType
Case "Ascii"
Analyzer.WriteString ":FORM:DATA ASC", True

**** Get the frequency data.
Analyzer.WriteString ":SENS1:FREQ:DATA?", True
FreqData = Analyzer.ReadList(ASCIIType_R8, ",")

**** Get the measurement data.
Analyzer.WriteString ":CALC1:DATA:FDAT?", True
ReadData = Analyzer.ReadList(ASCIIType_R8, ",")
Case "Binary"
Analyzer.WriteString ":FORM:DATA REAL", True

**** Get the frequency data.
Analyzer.WriteString ":SENS1:FREQ:DATA?", True
FreqData = Analyzer.ReadIEEEBlock(BinaryType_R8, False, True)

**** Get the measurement data.
Analyzer.WriteString ":CALC1:DATA:FDAT?", True
ReadData = Analyzer.ReadIEEEBlock(BinaryType_R8, False, True)
End Select

**** Set data for new sheet
ActiveSheet.Cells(10, 1) = "Frequency"
ActiveSheet.Cells(10, 2) = "Primary"
ActiveSheet.Cells(10, 3) = "Secondary"
ActiveSheet.Range("A11:C1000").Clear
For i = 1 To Poin
  ActiveSheet.Cells(i + 10, 1) = FreqData(i - 1)
  ActiveSheet.Cells(i + 10, 2).Value = ReadData(i * 2 - 2)
  ActiveSheet.Cells(i + 10, 3).Value = ReadData(i * 2 - 1)
Next i

**** End procedure

```

E4990A Impedance Analyzer Help

Analyzer.IO.Close

End Sub

Writing Data

Sub Write_Click()

Dim WriteData() As Double

Dim Poin As Integer, DataType As String, TraceNo As String

**** The variables of the resource manager and the instrument I/O are declared.

Dim ioMgr As VisaComLib.ResourceManager

Dim Analyzer As VisaComLib.FormattedIO488

**** The memory area of the resource manager and the instrument I/O are acquired.

Set ioMgr = New VisaComLib.ResourceManager

Set Analyzer = New VisaComLib.FormattedIO488

**** Open the instrument.

Set Analyzer.IO = ioMgr.Open("GPIB0::17::INSTR")

Analyzer.IO.Timeout = 10000

**** Abort sweeping.

Analyzer.WriteString ":INIT1:CONT OFF", True

Analyzer.WriteString ":ABOR", True

**** Select trace

TraceNo = Cells(3, 2)

Analyzer.WriteString ":CALC1:PAR" & TraceNo & ":SEL", True

**** Get number of point.

Analyzer.WriteString ":SENS1:SWE:POIN?", True

Poin = Analyzer.ReadNumber

ReDim WriteData(Poin * 2 - 1) As Double

**** Set data for array variable, and send data for the Analyzer

For i = 1 To Poin

WriteData(i * 2 - 2) = ActiveSheet.Cells(i + 10, 2).Value

```

WriteData(i * 2 - 1) = ActiveSheet.Cells(i + 10, 3).Value
Next i

DataType = Cells(5, 2)
Select Case DataType
Case "Ascii"
Analyzer.WriteString ":FORM:DATA ASC", True
Analyzer.WriteString "CALC1:DATA:FDAT ", False
Analyzer.WriteList WriteData, ASCIIType_R8, ",", True
Case "Binary"
Analyzer.WriteString ":FORM:DATA REAL", True
Analyzer.WriteIEEEBlock ":CALC1:DATA:FDAT ", WriteData, True
End Select

*** End procedure
Analyzer.IO.Close

End Sub

```

Processing Measurement Results

Processing Measurement Results

- [Searching Peak](#)
- [Setting the Limit Test Functions](#)

Searching Peak

- [Overview](#)
- [Sample Program in Excel VBA](#)

[Other topics about Processing Measurement Results](#)

Overview

The program listed in the below section is written in VISA-COM with Excel VBA. It can be executed from the external PC controller. The program demonstrates how to search peak.

Searching Peak Sample Program in Excel VBA

```

Dim ioMgr As VisaComLib.ResourceManager
Dim Ana As VisaComLib.FormattedIO488

```

E4990A Impedance Analyzer Help

Sub PeakSearch_Click()

Range("B6:I30").Clear

Dim Excursion As Double

Dim Freq As Double, Resp As Variant, PeakPoint As Variant

Dim Poin As Long, Stat As Long, Dummy As Long

Excursion = 1

Set ioMgr = New VisaComLib.ResourceManager

Set Ana = New VisaComLib.FormattedIO488

'

**** Open the instrument.

Set Ana.IO = ioMgr.Open("GPIB0::17::INSTR")

Ana.IO.timeout = 10000

'

' Setup Analyzer

Ana.WriteString ":SYST:PRES", True

Ana.WriteString ":INIT:CONT ON", True

Ana.WriteString ":TRIG:SOUR BUS", True

Ana.WriteString ":SENS1:FREQ:CENT 950E6", True

Ana.WriteString ":SENS1:FREQ:SPAN 200E6", True

Ana.WriteString ":SENS1:SWE:POIN 201", True

Ana.WriteString ":CALC1:PAR1:DEF S21", True

Ana.WriteString ":CALC1:PAR1:SEL", True

' Select trace 1

' Make a Measurement

Ana.WriteString ":TRIG:SING", True

Ana.WriteString "*OPC?", True

' Wait measurement end

Dummy = Ana.ReadNumber

' Auto scale

Ana.WriteString ":DISP:WIND1:TRAC1:Y:AUTO", True

' Example of Marker Peak Search

Ana.WriteString ":CALC1:MARK:FUNC:DOM ON", True

Ana.WriteString ":CALC1:MARK:FUNC:DOM:STAR 900E6", True

Ana.WriteString ":CALC1:MARK:FUNC:DOM:STOP 1E9", True

```

' Search type: peak
Ana.WriteString ":CALC1:MARK1:FUNC:TYPE PEAK", True
' Set peak excursion
Ana.WriteString ":CALC1:MARK1:FUNC:PEXC " & Str(Excursion), True
' Peak Polarity: Positive
Ana.WriteString ":CALC1:MARK1:FUNC:PPOL POS", True
' Execute search
Ana.WriteString ":CALC1:MARK1:FUNC:EXEC", True
' Call ErrorCheck
' Read marker stimulus value
Ana.WriteString ":CALC1:MARK1:X?", True
Freq = Ana.ReadNumber
' Read marker value
Ana.WriteString ":CALC1:MARK1:Y?", True
Resp = Ana.ReadList
Cells(6, 2).Value = Val(Freq)
' Display real part of result.
Cells(6, 3).Value = Resp(0)
'

' Example of All Peak Search
Ana.WriteString ":CALC1:FUNC:DOM ON", True
Ana.WriteString ":CALC1:FUNC:DOM:STAR 900E6", True
Ana.WriteString ":CALC1:FUNC:DOM:STOP 1E9", True
' Search type: all peak
Ana.WriteString ":CALC1:FUNC:TYPE APEAK", True
' Set peak excursion
Ana.WriteString ":CALC1:FUNC:PEXC " & Str(Excursion), True
' Peak Polarity: positive
Ana.WriteString ":CALC1:FUNC:PPOL POS", True
' Execute search
Ana.WriteString ":CALC1:FUNC:EXEC", True
Ana.WriteString "**OPC?", True
Dummy = Ana.ReadNumber
Call ErrorCheck
' Read value
Ana.WriteString ":CALC1:FUNC:POIN?", True
Poin = Ana.ReadNumber

```

E4990A Impedance Analyzer Help

```
' Read stimulus point number
Ana.WriteString ":CALC1:FUNC:DATA?", True
PeakPoint = Ana.ReadList
j = 0
For i = 1 To Poin
    Cells(5 + i, 5).Value = Val(PeakPoint(j))
    Cells(5 + i, 6).Value = Val(PeakPoint(j + 1))
    j = j + 2
Next i
'

' Example of Multi Peak Search
Ana.WriteString ":CALC1:MARK:FUNC:MULT:TYPE PEAK", True
Ana.WriteString ":CALC1:MARK:FUNC:MULT:PEXC " & Str(Excursion), True
Ana.WriteString ":CALC1:MARK:FUNC:MULT:PPOL POS", True
Ana.WriteString ":CALC1:MARK:FUNC:EXEC", True
Ana.WriteString "*OPC?", True
Dummy = Ana.ReadNumber
Call ErrorCheck
For i = 1 To 9
    ' Check if marker is active.
    Ana.WriteString ":CALC1:MARK" & i & "?", True
    Stat = Ana.ReadNumber
    If Stat = 1 Then
        ' Read marker stimulus value
        Ana.WriteString ":CALC1:MARK" & i & ":X?", True
        Freq = Ana.ReadNumber
        ' Read marker value
        Ana.WriteString ":CALC1:MARK" & i & ":Y?", True
        Resp = Ana.ReadList
        Cells(5 + i, 8).Value = Val(Freq)
        Cells(5 + i, 9).Value = Resp(0)
    End If
Next i

Ana.IO.Close
'

End Sub
```

```

Sub ErrorCheck()
    Dim err As Variant
    ' Reads error message.
    Ana.WriteString ":SYST:ERR?", True
    err = Ana.ReadList
    If Val(err(0)) <> 0 Then
        ' Display the message box.
        Response = MsgBox(CStr(err(1)), vbOKOnly)
    End If
End Sub

```

Setting the Limit Test Functions

- [Overview](#)
- [Sample Program in Excel VBA](#)

[Other topics about Processing Measurement Results](#)

Overview

The program listed in the below section is written in VISA-COM with Excel VBA. It can be executed from the external PC controller. The program demonstrates how to set the limit test functions.

Setting the Limit Test Functions Sample Program in Excel VBA

```

Private Sub Measure_Click()
    Dim ioMgr As VisaComLib.ResourceManager
    Dim Ana As VisaComLib.FormattedIO488

    Dim Star As Double, Stp As Double
    Dim Param(1) As String, Fmt(1) As String, SwpFmt As String
    Dim NumofSeg(1) As Integer

    Dim LimTbl1 As LimitTbl1, LimTbl2 As LimitTbl2

    Dim Dummy As Integer, ret As Integer

    Dim Lim_Judge As Integer
    Dim Tr1_Judge As Integer
    Dim Tr2_Judge As Integer
    Dim Fail_Point As Integer
    Dim Fail_Data As Variant

```

E4990A Impedance Analyzer Help

Dim Fail_Point2 As Integer

Dim Fail_Data2 As Variant

*** The memory area of the resource manager and the instrument I/O are acquired.

Set ioMgr = New VisaComLib.ResourceManager

Set Ana = New VisaComLib.FormattedIO488

*** Open the instrument.

Set Ana.IO = ioMgr.Open("GPIB0::17::INSTR")

Ana.IO.timeout = 10000

Ana.WriteString ":SYST:PRES", True

Ana.WriteString ":SYST:BEEP:WARN:STAT OFF", True

* Clear Fail Point Data on the sheet.

Range("E27:F100").Clear

Range("C26:C28").ClearContents

* Set variable of measurement condition.

Star = CDbI(Cells(3, 3).Value)

Stp = CDbI(Cells(4, 3).Value)

SwpFmt = Cells(5, 3).Value

Param(0) = Trim(Cells(6, 3).Value)

Fmt(0) = Trim(Cells(7, 3).Value)

Param(1) = Trim(Cells(8, 3).Value)

Fmt(1) = Trim(Cells(9, 3).Value)

,

* Set variable of limit tables.

NumofSeg(0) = 4

NumofSeg(1) = 3

,

For i = 0 To NumofSeg(0) - 1

With LimTbl1

If Trim(Cells(13 + i, 3).Value) = "MAX" Then

.Typ(i) = 1

Else

.Typ(i) = 2

```

    End If
    .BeginStim(i) = CDbI(Cells(13 + i, 4).Value)
    .EndStim(i) = CDbI(Cells(13 + i, 5).Value)
    .BeginResp(i) = CDbI(Cells(13 + i, 6).Value)
    .EndResp(i) = CDbI(Cells(13 + i, 7).Value)
  End With
Next i
'

For i = 0 To NumofSeg(1) - 1
  With LimTbl2
    If Trim(Cells(20 + i, 3).Value) = "MAX" Then
      .Typ(i) = 1
    Else
      .Typ(i) = 2
    End If
    .BeginStim(i) = CDbI(Cells(20 + i, 4).Value)
    .EndStim(i) = CDbI(Cells(20 + i, 5).Value)
    .BeginResp(i) = CDbI(Cells(20 + i, 6).Value)
    .EndResp(i) = CDbI(Cells(20 + i, 7).Value)
  End With
Next i
'

**** Send measurement condition to the Ana
Ana.WriteString ":SENS1:FREQ:STAR " + CStr(Star), True
Ana.WriteString ":SENS1:FREQ:STOP " + CStr(Stp), True
Ana.WriteString ":SENS1:SWE:TYPE " + SwpFmt, True
Ana.WriteString ":CALC1:PAR1:COUN 2", True
Ana.WriteString ":DISP:WIND1:SPL D1_2", True

Ana.WriteString ":TRIG:SOUR BUS", True ' Triger souce: bus
Ana.WriteString ":INIT1:CONT ON", True ' Triger mode: Continuos
'

* Send measurement parameter and format of trace 1 to the Ana.
Ana.WriteString ":CALC1:PAR1:SEL", True
Ana.WriteString ":CALC1:PAR1:DEF " + Param(0), True
Ana.WriteString ":DISP:WIND1:TRAC1:Y:SPAC " + Fmt(0), True ' Set Y-Axis at Log format

```

E4990A Impedance Analyzer Help

* Send limit table of trace 1 to the Ana.

```
Ana.WriteString ":CALC1:LIM:DATA " + CStr(NumofSeg(0)), False
```

```
For i = 0 To NumofSeg(0) - 1
```

```
  With LimTbl1
```

```
    Ana.WriteString "," + CStr(.Typ(i)), False
```

```
    Ana.WriteString "," + CStr(.BeginStim(i)), False
```

```
    Ana.WriteString "," + CStr(.EndStim(i)), False
```

```
    Ana.WriteString "," + CStr(.BeginResp(i)), False
```

```
  If i = NumofSeg(0) - 1 Then
```

```
    Ana.WriteString "," + CStr(.EndResp(i)), True
```

```
  Else
```

```
    Ana.WriteString "," + CStr(.EndResp(i)), False
```

```
  End If
```

```
End With
```

```
Next i
```

```
Ana.WriteString ":CALC1:LIM:DISP ON", True
```

```
Ana.WriteString ":CALC1:LIM:DISP:CLIP OFF", True
```

```
Ana.WriteString ":CALC1:LIM ON", True
```

```
,
```

* Send measurement parameter and format of trace 2 to the Ana.

```
Ana.WriteString ":CALC1:PAR2:SEL", True
```

```
Ana.WriteString ":CALC1:PAR2:DEF " + Param(1), True
```

```
Ana.WriteString ":DISP:WIND1:TRAC2:Y:SPAC " + Fmt(1)
```

* Send limit table of trace 2 to the Ana.

```
Ana.WriteString ":CALC1:LIM:DATA " + CStr(NumofSeg(1)), False
```

```
For i = 0 To NumofSeg(1) - 1
```

```
  With LimTbl2
```

```
    Ana.WriteString "," + CStr(.Typ(i)), False
```

```
    Ana.WriteString "," + CStr(.BeginStim(i)), False
```

```
    Ana.WriteString "," + CStr(.EndStim(i)), False
```

```
    Ana.WriteString "," + CStr(.BeginResp(i)), False
```

```
  If i = NumofSeg(1) - 1 Then
```

```
    Ana.WriteString "," + CStr(.EndResp(i)), True
```

```
  Else
```

```
    Ana.WriteString "," + CStr(.EndResp(i)), False
```

```
  End If
```

```

    End With
Next i
Ana.WriteString ":CALC1:LIM:DISP ON", True
Ana.WriteString ":CALC1:LIM:DISP:CLIP OFF", True
Ana.WriteString ":CALC1:LIM ON", True
Ana.WriteString "**OPC?", True
Dummy = Ana.ReadNumber
'
*** Setting status resister.
Ana.WriteString ":STAT:QUES:LIM:PTR 2", True
Ana.WriteString ":STAT:QUES:LIM:NTR 0", True
Ana.WriteString ":STAT:QUES:LIM:CHAN1:ENAB 6", True
Ana.WriteString ":STAT:QUES:LIM:CHAN1:PTR 6", True
Ana.WriteString ":STAT:QUES:LIM:CHAN1:NTR 0", True

' Clear status register
Ana.WriteString "**CLS", True
' Wait register clear end.
Ana.WriteString "**OPC?", True
Dummy = Ana.ReadNumber
'
** Trigger
' Make a single trigger.
Ana.WriteString ":TRIG:SING", True
' Wait measurement end.
Ana.WriteString "**OPC?", True
Dummy = Ana.ReadNumber
'
** Checking test results.
Ana.WriteString ":STAT:QUES:LIM?", True
ret = Ana.ReadNumber
Lim_Judge = ret And 2
Ana.WriteString ":STAT:QUES:LIM:CHAN1?", True
ret = Ana.ReadNumber
Tr1_Judge = ret And 2
Tr2_Judge = ret And 4
'

```

E4990A Impedance Analyzer Help

**** Displaying test results.

If Lim_Judge = 0 Then

Cells(26, 3).Value = "PASS"

Else

Cells(26, 3).Value = "FAIL"

End If

If Tr1_Judge = 0 Then

Cells(27, 3).Value = "PASS"

Else

Cells(27, 3).Value = "FAIL"

Ana.WriteString ":CALC1:PAR1:SEL", True

Ana.WriteString ":CALC1:LIM:REP:POIN?", True

Fail_Point = Ana.ReadNumber

ReDim Fail_Data(Fail_Point - 1)

ptr = VarPtr(Fail_Data(0))

Ana.WriteString ":CALC1:LIM:REP?", True

Fail_Data = Ana.ReadList(ASCIIType_R8, ",")

For i = 0 To Fail_Point - 1

Cells(27 + i, 5).Value = Fail_Data(i)

Next i

End If

If Tr2_Judge = 0 Then

Cells(28, 3).Value = "PASS"

Else

Cells(28, 3).Value = "FAIL"

Ana.WriteString ":CALC1:PAR2:SEL", True

Ana.WriteString ":CALC1:LIM:REP:POIN?", True

Fail_Point2 = Ana.ReadNumber

ReDim Fail_Data2(Fail_Point2 - 1)

Ana.WriteString ":CALC1:LIM:REP?", True

Fail_Data2 = Ana.ReadList(ASCIIType_R8, ",")

For i = 0 To Fail_Point2 - 1

Cells(27 + i, 6).Value = Fail_Data2(i)

Next i

End If

```
Ana.IO.Close
```

```
End Sub
```

Saving/Recalling a Measurement Result/Measurement Setup

Saving/Recalling a Measurement Result/Measurement Setup

- [Saving Data Into a File](#)
- [Capturing Screen Into PC](#)
- [Transferring Files](#)

Saving Data Into a File

- [Overview](#)
- [Sample Program in Excel VBA](#)

Other topics about Saving/Recalling a Measurement Result

Overview

The program listed in the below section is written in VISA-COM with Excel VBA. It can be executed from the external PC controller. The program demonstrates how to save data into a file.

Saving Data Into a File Sample Program in Excel VBA

```
Private Sub File_Save_Click()
    ' Declare two string variables for file name and file type
    Dim File_Name As String
    Dim File_Type As String
    Dim ioMgr As VisaComLib.ResourceManager
    Dim Ana As VisaComLib.FormattedIO488

    **** The memory area of the resource manager and the instrument I/O are acquired.
    Set ioMgr = New VisaComLib.ResourceManager
    Set Ana = New VisaComLib.FormattedIO488

    **** Open the instrument.
    Set Ana.io = ioMgr.Open("GPIB0::17::INSTR")
    Ana.io.timeout = 10000

    ' Check whether file name textbox is empty or not
    If TextBox1.Text <> "" Then
```

E4990A Impedance Analyzer Help

```
File_Name = Trim(TextBox1.Text)
File_Type = Trim(frmFileSave.ComboBox1.Value)
```

```
' Open connection to the Ana
```

```
Select Case File_Type
```

```
Case "1: State (State Only)"
```

```
    Ana.writestring ":MMEM:STOR:STYP STAT", True
```

```
    Ana.writestring ":MMEM:STOR "" & File_Name & ".sta""", True
```

```
Case "2: State (State & Cal)"
```

```
    Ana.writestring ":MMEM:STOR:STYP CST", True
```

```
    Ana.writestring ":MMEM:STOR "" & File_Name & ".sta""", True
```

```
Case "3: State (State & Trace)"
```

```
    Ana.writestring ":MMEM:STOR:STYP DST", True
```

```
    Ana.writestring ":MMEM:STOR "" & File_Name & ".sta""", True
```

```
Case "4: State (All)"
```

```
    Ana.writestring ":MMEM:STOR:STYP CDST", True
```

```
    Ana.writestring ":MMEM:STOR "" & File_Name & ".sta""", True
```

```
Case "5: Trace Data (CSV)"
```

```
    Ana.writestring ":MMEM:STOR:FDAT "" & File_Name & ".csv""", True
```

```
Case "6: Screen Image (BMP)"
```

```
    Ana.writestring ":MMEM:STOR:IMAG "" & File_Name & ".bmp""", True
```

```
Case Else
```

```
    MsgBox "Error in code"
```

```
End Select
```

```
Ana.io.Close
```

```
Else
```

```
    MsgBox "Please enter a filename"
```

```
End If
```

```
End Sub
```

```
Private Sub UserForm_Initialize()
```

```
    ComboBox1.AddItem "1: State (State Only)"
```

```
    ComboBox1.AddItem "2: State (State & Cal)"
```

```
    ComboBox1.AddItem "3: State (State & Trace)"
```

```
    ComboBox1.AddItem "4: State (All)"
```

```
    ComboBox1.AddItem "5: Trace Data (CSV)"
```

```
    ComboBox1.AddItem "6: Screen Image (BMP)"
```

```
ComboBox1.ListIndex = 0
```

```
TextBox1.Text = "D:\TempFile"
```

```
End Sub
```

Capturing Screen Into PC

- [Overview](#)
- [Sample Program in Excel VBA](#)

[Other topics about Saving/Recalling a Measurement Result](#)

Overview

The program listed in the below section is written in VISA-COM with Excel VBA. It can be executed from the external PC controller. The program demonstrates how to capture screen into PC.

Capturing Screen Into PC Sample Program in Excel VBA

```
Sub ScreenCapture()
```

```
    *** The variables of the resource manager and the instrument I/O are declared.
```

```
    Dim ImgData() As Byte
```

```
    Dim FilAnalyzerme As String
```

```
    Dim ioMgr As VisaComLib.ResourceManager
```

```
    Dim Analyzer As VisaComLib.FormattedIO488
```

```
    *** The memory area of the resource manager and the instrument I/O are acquired.
```

```
    Set ioMgr = New VisaComLib.ResourceManager
```

```
    Set Analyzer = New VisaComLib.FormattedIO488
```

```
    *** Open the instrument.
```

```
    Set Analyzer.IO = ioMgr.Open("GPIB0::17::INSTR")
```

```
    Analyzer.IO.timeout = 10000
```

```
    FilAnalyzerme = Range("B7").Value
```

```
    Analyzer.WriteString ":HCOP:SDUM:DATA:FORM PNG", True
```

```
    Analyzer.WriteString ":HCOP:SDUM:DATA?", True
```

```
    ImgData = Analyzer.ReadIEEEBlock(BinaryType_UI1, False, True)
```

```
    Open FilAnalyzerme For Binary As #1
```

```
        Put #1, , ImgData()
```

E4990A Impedance Analyzer Help

Close

*** End of procedure

Analyzer.IO.Close

End Sub

Transferring Files

- [Overview](#)
- [Sample Program in Excel VBA](#)

[Other topics about Saving/Recalling a Measurement Result](#)

Overview

The program listed in the below section is written in VISA-COM with Excel VBA. It can be executed from the external PC controller. The program demonstrates how to transfer files.

Transferring Files Sample Program in Excel VBA

```
Private Sub fromAna_toPC_Click()
```

```
    *** This sequence is a sample code in which the file is transferred
```

```
    *** from the Ana to the external controller.
```

```
    Dim hFile As Long
```

```
    Dim isOpen As Boolean
```

```
    Dim ioMgr As VisaComLib.ResourceManager
```

```
    Set ioMgr = New VisaComLib.ResourceManager
```

```
    Dim Ana As VisaComLib.FormattedIO488
```

```
    Set Ana = New VisaComLib.FormattedIO488
```

```
    Set Ana.IO = ioMgr.Open("GPIB0::17::INSTR")
```

```
    Ana.IO.Timeout = 10000
```

```
    Dim byteData() As Byte
```

```
    Dim Ana_File As String
```

```
    Dim PC_File As String
```

```
    Ana_File = "" & Trim(TextBox2.Text) & ""
```

```
    PC_File = Trim(TextBox1.Text)
```

```
    Ana.WriteString ":MMEM:TRAN? " & Ana_File
```

```

byteData = Ana.ReadIEEEBlock(BinaryType_UI1)

hFile = FreeFile()
Open PC_File For Binary Access Write Shared As hFile
isOpen = True

Put #hFile, , byteData
If isOpen Then Close #hFile
Ana.IO.Close
End Sub

Private Sub fromPC_toAna_Click()
    **** This sequence is a sample code in which the file is transferred
    **** from the external controller to the Ana.
    Dim hFile As Long
    Dim isOpen As Boolean
    Dim ioMgr As VisaComLib.ResourceManager
    Set ioMgr = New VisaComLib.ResourceManager

    Dim Ana As VisaComLib.FormattedIO488
    Set Ana = New VisaComLib.FormattedIO488

    Set Ana.IO = ioMgr.Open("GPIB0::17::INSTR")
    Ana.IO.Timeout = 10000

    Dim byteData() As Byte
    Dim strBuf As String
    Dim fileSize As Long
    Dim Ana_File As String
    Dim PC_File As String
    Ana_File = "" & Trim(TextBox2.Text) & ""
    PC_File = Trim(TextBox1.Text)

    fileSize = FileLen(PC_File)
    ReDim byteData(fileSize - 1)
    hFile = FreeFile()
    Open PC_File For Binary Access Read Shared As hFile

```

E4990A Impedance Analyzer Help

```
isOpen = True
```

```
Get #hFile, , byteData
```

```
If isOpen Then Close #hFile
```

```
strBuf = ":MMEM:TRAN " & Ana_File & ", "
```

```
Ana.WritelEEEBlock strBuf, byteData, True
```

```
Ana.IO.Close
```

```
End Sub
```

```
Private Sub UserForm_Initialize()
```

```
    TextBox1.Text = "C:\temp\temp.png"
```

```
    TextBox2.Text = "D:\temp.png"
```

```
End Sub
```

```
Private Sub EndBtn_Click()
```

```
    End
```

```
End Sub
```

Communication with External Equipment (Using I/O Ports)

Communication with External Equipment (Using I/O Ports)

- [24 Bit Handler IO Port Overview](#)
- [I/O Signal Pin Layout and Description](#)
- [Inputting/Outputting Data](#)
- [Preset States at Power ON](#)
- [Timing Chart](#)
- [Electrical Characteristics](#)

24 Bit (Handler) I/O Port Overview

The E4990A 24 Bit (handler) I/O port provides four independent parallel ports for data I/O associated with several control signal lines and the power line. All signals operate in TTL logic.

The data I/O ports are configured with 2 pairs of 8 bit output port and 2 pairs of 4 bit bi-directional port. Also those ports can cooperate to provide a maximum 16-bit-width output port or a maximum 8-bit-width input port.

The I/O signals operate on the negative logic basis, which can be altered. The control signal lines consist of various control output data, including completion of measurement or control signal for handshaking.

I/O ports and control signal lines

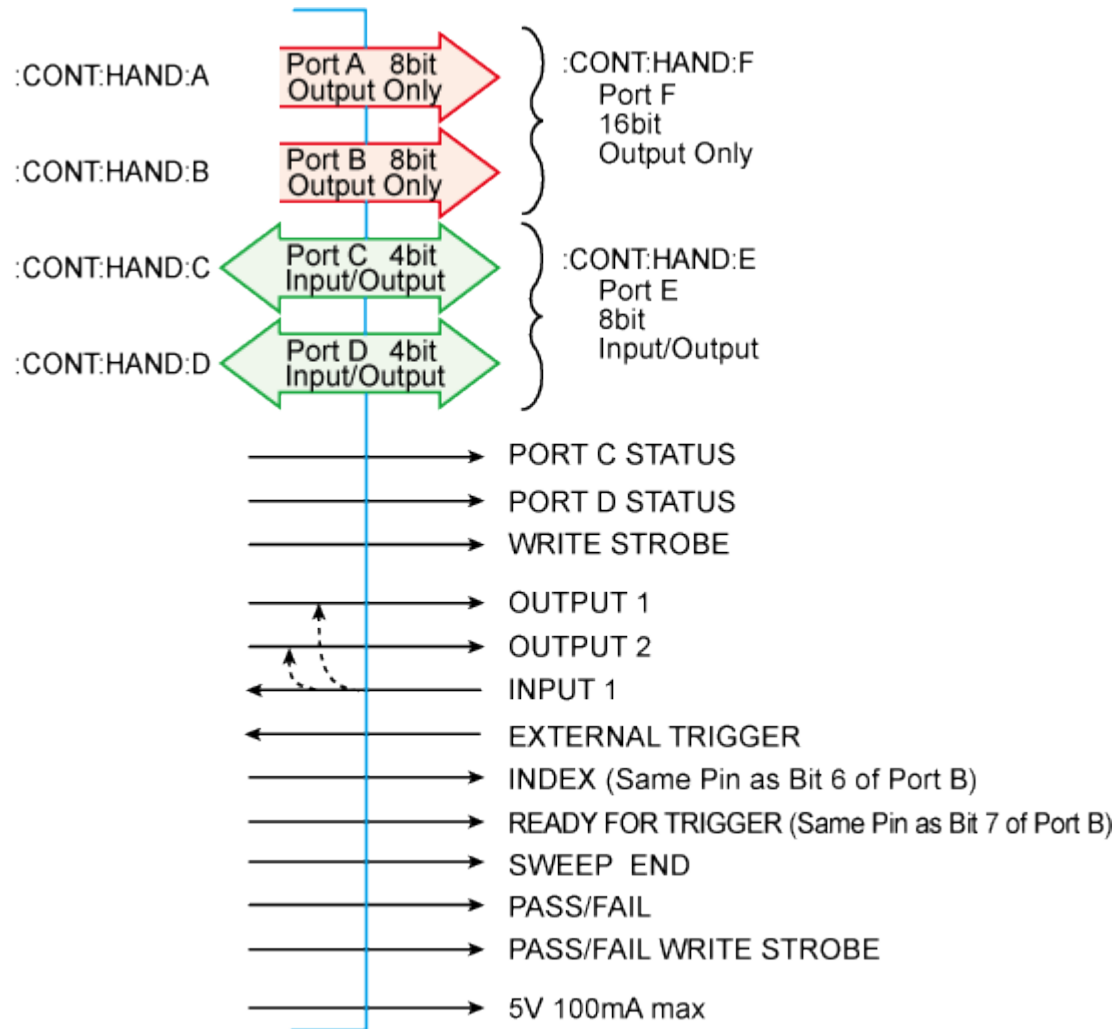

e5071c364

[Other topics about Communication with External Devices](#)

I/O Signal Pin Layout and Description

The layout of the I/O signal pins on the handler interface connector and its description are shown below.

E4990A Impedance Analyzer Help

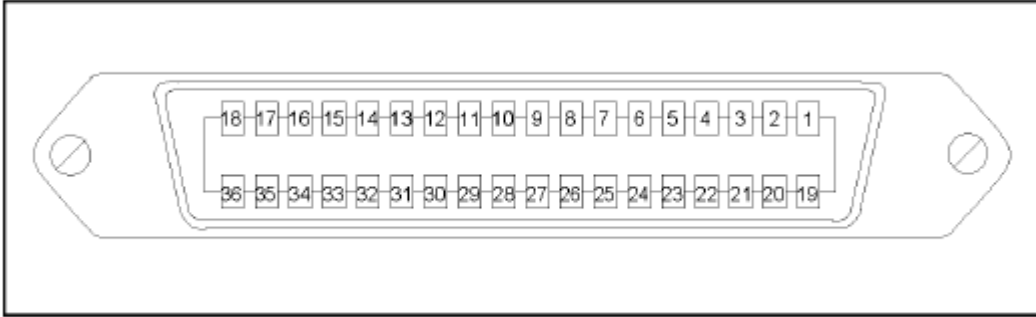

e4990a025

A slash (/) symbol preceding signal names means that they are negative logic (active low).

Pin number Signal name Signal specification

Pin Number	Signal	Signal Specification
1	GND	0 V. Ground
2	/INPUT1	When this port receives a negative pulse, /OUTPUT1 and /OUTPUT2 are changed to the Low level.
3	/OUTPUT1	Changes to the Low level when /INPUT1 receives a negative pulse. A command is available for altering the Low/High level logic.
4	/OUTPUT2	Changes to the Low level when /INPUT1 receives a negative pulse. A command is available for altering the Low/High level logic.
5	/PORT A0	Bit 0 of port A (8 bit parallel output port).
6	/PORT A1	Bit 1 of port A.
7	/PORT A2	Bit 2 of port A.
8	/PORT A3	Bit 3 of port A.
9	/PORT A4	Bit 4 of port A.

10	/PORT A5	Bit 5 of port A.
11	/PORT A6	Bit 6 of port A.
12	/PORT A7	Bit 7 of port A.
13	/PORT B0	Bit 0 of port B (8 bit parallel output port).
14	/PORT B1	Bit 1 of port B.
15	/PORT B2	Bit 2 of port B.
16	/PORT B3	Bit 3 of port B.
17	/PORT B4	Bit 4 of port B.
18	/PORT B5	Bit 5 of port B.
19	/PORT B6	Bit 6 of port B.
	/INDEX	<p>Indicates that analog measurement is complete. The /INDEX signal changes to the Low level when analog measurement (all sweeps of all channels) is complete. When the handler receives the signal, it assumes that it is ready to connect the next DUT. However, no measurement data is available until data calculation is completed.</p> <p>When the point trigger function is ON, it goes to the High level before starting measurement of the first measurement point and returns to the Low level after completing measurement of all measurement points.</p>
20	/PORT B7	Bit 7 of port B.
	/READY FOR TRIGGER	Indicates that the instrument is ready for triggering. This signal is changed to the Low level when the instrument is ready to receive a

		<p>trigger signal.</p> <p>The /READY FOR TRIGGER signal goes to the Low level when the instrument is ready to accept the trigger signal for the first point and goes to the High level when the trigger signal for the first point is received.</p> <p>When the point trigger is OFF: When measurement of all measurement points is completed and the instrument is ready to receive the trigger signal for the first point of the next sweep, this signal goes to the Low level again.</p> <p>When the point trigger is ON: When each measurement point is completed and the instrument is ready to receive the trigger signal for the next measurement point, this signal goes to the Low level again.</p>
21	/PORT C0	Bit 0 of port C (4 bit parallel I/O port).
22	/PORT C1	Bit 1 of port C.
23	/PORT C2	Bit 2 of port C.
24	/PORT C3	Bit 3 of port C.
25	/PORT D0	Bit 0 of port D (4 bit parallel I/O port).
26	/PORT D1	Bit 1 of port D.
27	/PORT D2	Bit 2 of port D.
28	/PORT D3	Bit 3 of port D.
29	PORT C STATUS	Port C status signal. This signal is changed to the High level when the port C is configured to output port. It is changed to the Low level when the port is configured to input port.

30	PORT D STATUS	Port D status signal. This signal is changed to the High level when the port D is configured to output port. It is changed to the Low level when the port is configured to input port.
31	/WRITE STROBE	A output port write strobe signal. When data is present (that is, output level changes) on any of the output ports, this signal provides a negative pulse.
32	+5V pull-up	Provides +5V DC power supply for external instruments.
33	/SWEEP END	A sweep completion signal. When measurement (all sweeps of all channels) and data calculation are completed, this signal provides a negative pulse.
34	+5V	Provides +5V DC power supply for external instruments.
35	/PASS FAIL	Each limit test's results signal. This signal changes to the High level when limit test, or bandwidth test results return FAIL. It changes to the Low level when all limit test results return PASS.
36	/PASS FAIL STROBE	Each limit test's results write a strobe signal. When limit test result is present on /PASS FAIL, this signal provides a negative pulse.

NOTE Pin 19 has 2 features: Port B6 and INDEX. This feature is controlled by [CONT:HAND:EXT:IND:STAT](#) command.

NOTE Pin 20 has 2 features: Port B7 and READY FOR TRIGGER. This feature is controlled by [CONT:HAND:EXT:RTR:STAT](#) command.

[Other topics about Communication with External Devices](#)

Inputting Outputting Data

- [Overview](#)
- [Specifying Signal Direction of Port](#)
- [Reading Data Input from Port](#)

- [Data Output to Port](#)

[Other topics about Communication with External Devices](#)

Overview

The E4990A 24 Bit (Handler) I/O port provides the ports for data I/O shown below.

Port Name	Usage	Data Structure
Port A	Output	<p>A7 A6 A5 A4 A3 A2 A1 A0 8 bits</p>
Port B	Output	<p>B7 B6 B5 B4 B3 B2 B1 B0 8 bits</p>
Port C	Input/Output	<p>C3 C2 C1 C0 4 bits</p>
Port D	Input/Output	<p>D3 D2 D1 D0 4 bits</p>
Port E	Input/Output	<p>D3 D2 D1 D0 C3 C2 C1 C0 8 bits</p>
Port F	Output	<p>B7 B6 B5 B4 B3 B2 B1 B0 A7 A6 A5 A4 A3 A2 A1 A0 16 bits</p>

Specifying Signal Direction of Port

Signal direction (input/output) can be changed for the ports C, D, and E as shown in [I/O ports and control signal lines](#). Thus, before the ports are used, the directions should be determined according to their usage.

To specify the signal direction for the ports C and D, use the following command. Direction for the port E depends on the setting for the ports C and D.

Port Name	Command
Port C	:CONT:HAND:C:MODE
Port D	:CONT:HAND:D:MODE

Reading Data Input into Port

When the ports C, D, or E are configured to input ports, binary data represented by High(0)/Low(1) of each bit of the port is read as decimal data.

To retrieve the data, use the following command as query:

Port Name	Command
Port C	:CONT:HAND:C
Port D	:CONT:HAND:D
Port E	:CONT:HAND:E

Data Output to Port

To ports A through F (the ports C, D, and E should be configured to output ports), binary data (decimal data when output data is specified with a command) represented by High(0)/Low(1) of each bit of the port can be output.

To output data, use the following command:

Port Name	Command
Port A	:CONT:HAND:A
Port B	:CONT:HAND:B

E4990A Impedance Analyzer Help

Port C	:CONT:HAND:C
Port D	:CONT:HAND:D
Port E	:CONT:HAND:E
Port F	:CONT:HAND:F

- The bit 6 of the data output by :CONT:HAND:B (the bit 14 of the data output by :CONT:HAND:F) is ignored when outputting the /INDEX signal is turned ON.
- The bit 7 of the data output by :CONT:HAND:B (the bit 15 of the data output by :CONT:HAND:F command) is ignored when outputting the /READY FOR TRIGGER signal is turned ON.

Preset States at power ON

The 24 bit (Handler) I/O port is set at power-on as follows (not affected at reset)

Description	Status
Port A	High (All Bits)
Port B	High (All Bits)
Port C	Input
Port D	Input
Port C STATUS	Low
Port D STATUS	Low
/OUTPUT1	High
/OUTPUT2	High
/SWEEP END	High

/PASS FAIL	High
------------	------

[Other topics about Communication with External Devices](#)

Timing Chart

- [Overview](#)
- [Timing Chart of I/O Port Signal](#)
- [Timing Chart of Data Output and Write Strobe Signal](#)
- [Timing Chart of Limit Test Result Output and Write Strobe Signal](#)
- [Timing Chart of /INPUT1 and /OUTPUT1, /OUTPUT2](#)

[Other topics about Communication with External Devices](#)

Overview

This section shows the typical timing chart of I/O port Signal.

Timing Chart of I/O Port Signal (Point Trigger: Off)

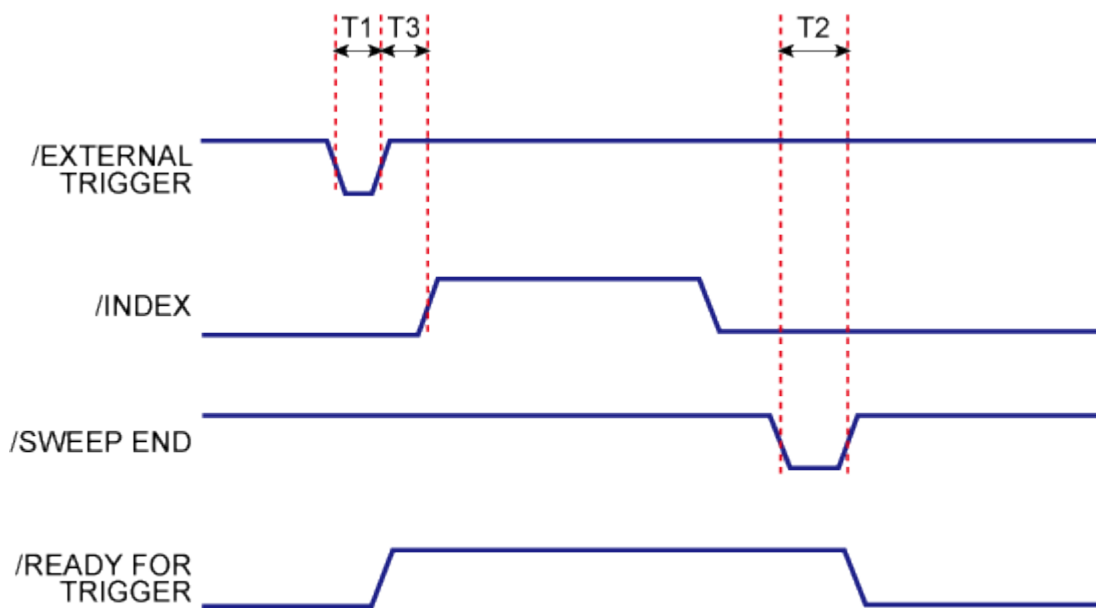

e5061b040

		Minimum value	Typical value	Maximum value
T1	Pulse width of /EXTERNAL TRIGGER or External Trigger Input	1 μ s	-	-

E4990A Impedance Analyzer Help

	Port			
T2	Pulse width of /SWEEP END	10 μ s	12 μ s	-
T3	Time set as the trigger delay time	-	(see below note)	-

NOTE

The Trigger Delay Time (T3) is not constant, because it is time that the user sets.

Timing Chart of I/O Port Signal (Point Trigger: On)

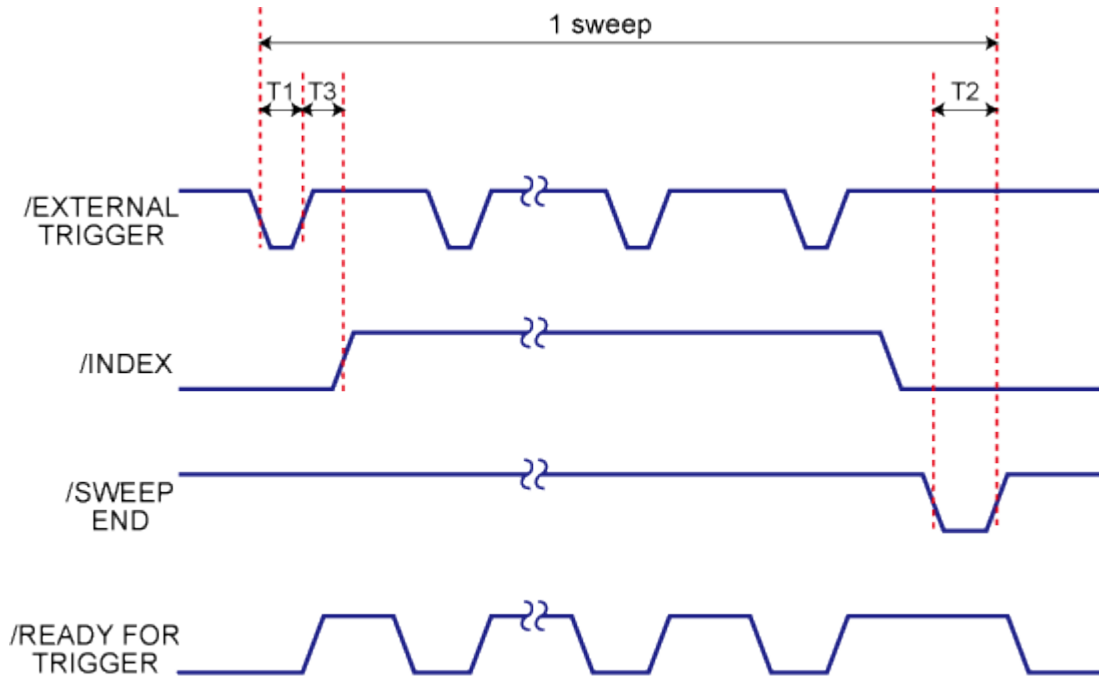

e5061b041

When the point trigger function is ON, the /EXTERNAL TRIGGER signal must be inputted for each measurement point during a single sweep. The /INDEX signal goes to the High level before starting measurement of the first measurement point and returns to the Low level after the completing measurement of all measurement points.

The /READY FOR TRIGGER signal goes to the Low level when the instrument is ready to accept the trigger signal for the first point and then goes to the High level when the trigger signal for the first point is received.

When measurement of all measurement points is completed and the instrument is ready to receive the trigger signal for the first point of the next sweep, this signal goes to the Low level again.

When the point trigger function is ON, the /READY FOR TRIGGER signal goes High each time a trigger signal is received and goes Low when measurement of each measurement point is completed and the instrument is ready to accept a trigger for the next measurement point.

The times of T1 and T2 are the same as those when the point trigger function is OFF. For more information, see [Timing chart of I/O Port Signal \(Point trigger function: OFF\)](#).

Timing Chart of Data Output and Write Strobe Signal

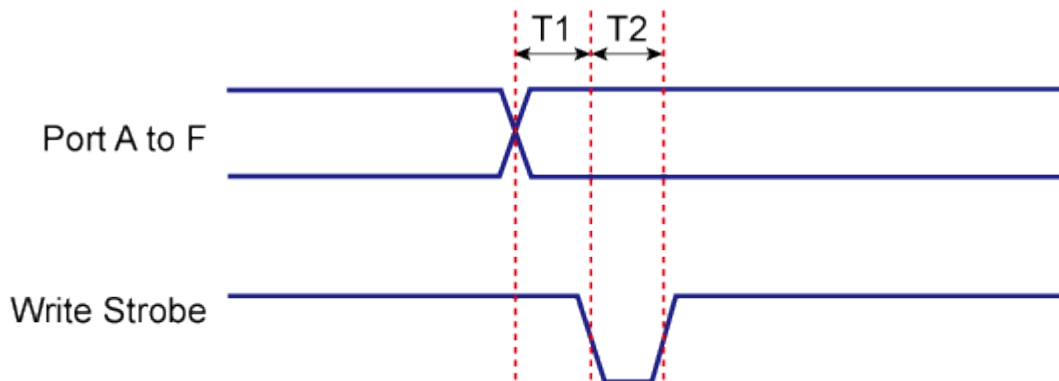

e5071c366

T1	Response time of write strobe signal	1 μ s
T2	Pulse width of write strobe signal	1 μ s

Timing Chart of Limit Test Result Output and Write Strobe Signal

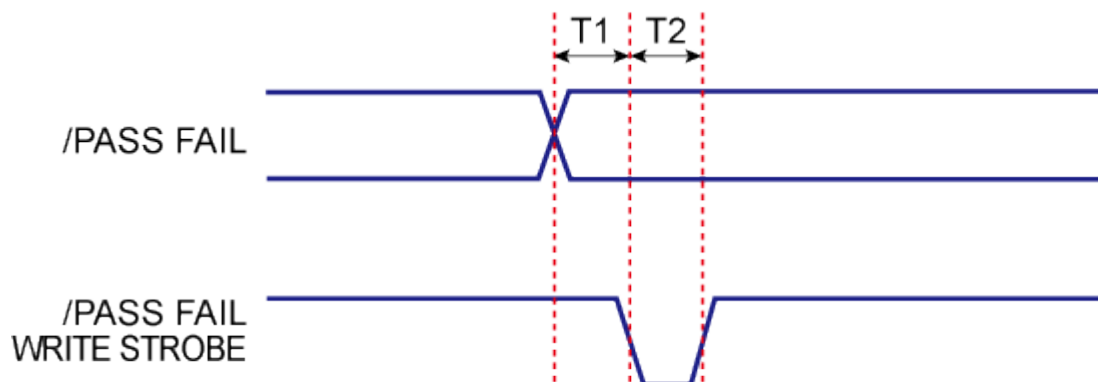

e5071c367

E4990A Impedance Analyzer Help

T1	Response time of /PASS FAIL write strobe	1 μ s
T2	Pulse width of /PASS FAIL write strobe	1 μ s

NOTE

When the average trigger function is activated, the fail and write strobe signals are output at the time that the average test result shows "failed" on a certain channel.

Timing Chart of /INPUT1 and /OUTPUT1, /OUTPUT2

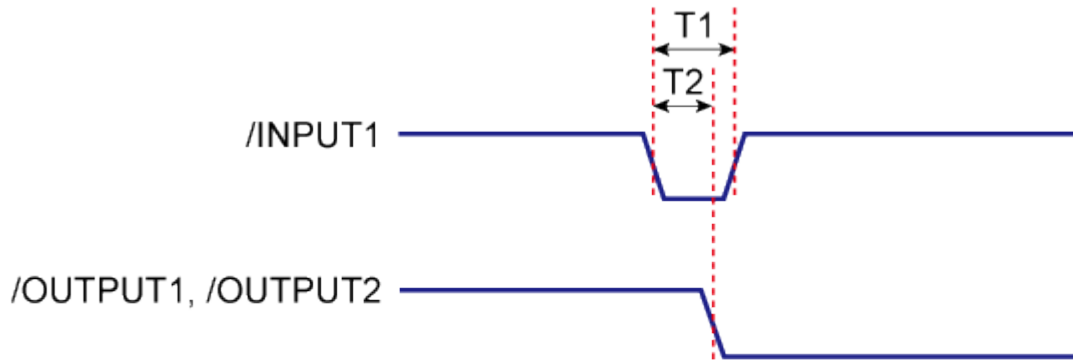

e5071c369

		Minimum value	Maximum value
T1	Pulse width of /INPUT1	1 μ s	-
T3	Response time of /OUTPUT1, /OUTPUT2	0.2 μ s	0.4 μ s

Electrical Characteristics

- [Input Signal](#)
- [Output Signal](#)
- [Power Supply \(+5V\)](#)

[Other topics about Communication with External Devices](#)

Input Signal

All input signals are TTL compatible.

Maximum rate input voltage	-0.5 V to 5.5 V
-----------------------------------	-----------------

Input voltage	High level	2.0 V to 5.0 V
	Low level	0 V to 0.5 V

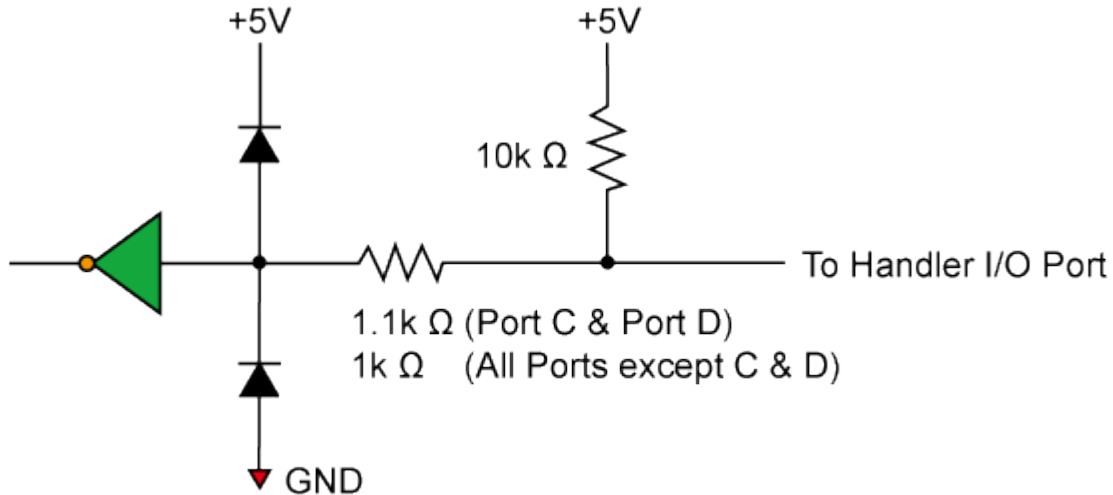

e5071c370

Output Signal

All output signals are TTL compatible.

Maximum rate output current		-10 mA to 10 mA
Output current	High level	-5 mA
	Low level	3 mA
Output voltage	High level	2.0 V to 3.3 V (when output current is from -5 mA to 0 mA) 3.20 V (when output current is -1 mA) 2.75 V (when output current is -5 mA)
	Low level	0 V to 0.8 V (when output current is from 0 mA to 3 mA) 0.25 V (when output current is 1 mA)

	0.55 V (when output current is 3 mA)
--	--------------------------------------

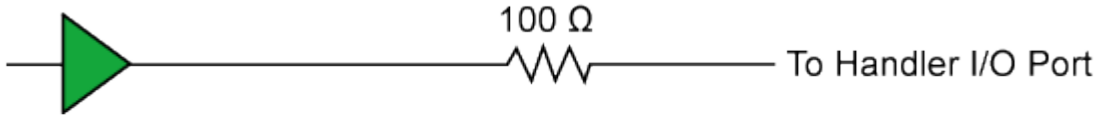

e5071c371

Power Supply (+5V)

The following table shows electrical characteristics of +5 V power supply for external instruments.

Output voltage	4.5 V to 5.5 V
Maximum output current	100 mA

Status Reporting System

Status Reporting System

- [General Status Register Model](#)
- [Status Register Structure](#)

General Status Register Model

- [Overview](#)
- [Event Register](#)
- [Enable Register](#)
- [Status Byte Register](#)
- [Condition Register and Transition Filter](#)
- [Commands for the Status Reporting System](#)

[Other topics about Status Reporting System](#)

Overview

The E4990A has a status reporting system to report the condition of the instrument.

General status register model

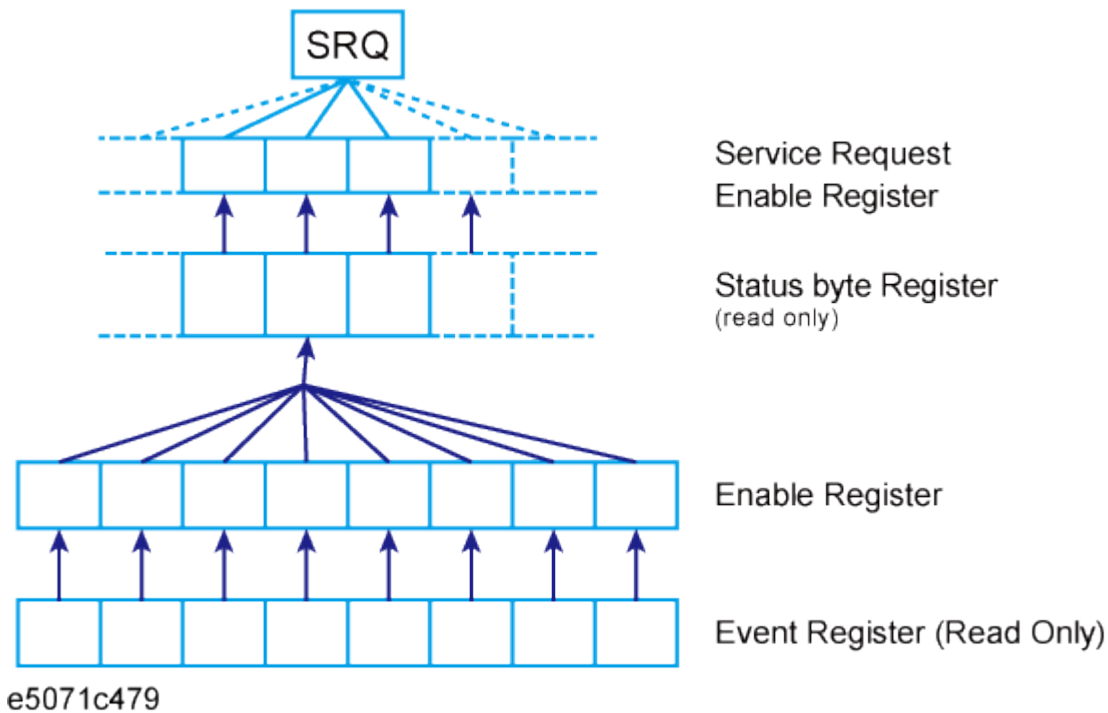

The status reporting system has a hierarchical structure as shown in the figure above. When the instrument satisfies a particular condition, the corresponding bit of the event register is set to 1. Therefore, you can check the instrument status by reading the event register.

When the event register bit is set to "1" and a corresponding enable register bit (a bit marked with an arrow in General status register model) is also "1," the summary bit of the status byte register is set to "1." You can read the status byte register by using the serial poll.

If the bit of the service request enable register is "1," a service request (SRQ) is generated by the positive transition of the corresponding status byte register bit. By generating SRQ, you can notify the controller that the E4990A is requesting service. In other words, interruption by SRQ can be programmed.

Event Register

Reflects the corresponding condition of the E4990A (e.g., occurrence of an event) as a bit status. These bits continuously monitor changes in the E4990A's state and change the bit status when the condition (e.g., change bit status to "1" if a specific event occurs) for each bit is met. You cannot change the bit status by issuing a SCPI command.

Enable Register

Setting the enable register allows you to specify event register bits that can set "1" to the summary bit of the status byte register when an event

occurs. The register bits work as mask bits; setting "1" to an enable register will enable a corresponding bit in the event register.

For example, when you want to set "1" as the summary bit in the status byte register by a specific register condition, set the corresponding enable register to "1."

Status Byte Register

If the enabled event register is set to "1," a corresponding bit of the status byte register is also set to "1." This register also indicates the output queue and SRQ status.

The value of the status byte register can be read by using the ***STB?** command or serial poll (SPOLL statement in HTBasic) from the controller.

Reading the status byte register by using the ***STB?** command does not affect the contents of the status byte register. However, reading it with the SPOLL statement of HTBasic clears the RQS bit in the status byte register.

Also, setting the service request enable register using the ***SRE** command can generate a service request synchronously with the status byte register.

Condition Register and Transition Filter

When the status register has a transition filter, there is a lower register called a condition register under the event register. The transition filter is between the event register and the condition register.

The transition filter enables you to select a positive and/or negative transition of the condition register bit in order to set a bit in the corresponding event register. For example, using the negative transition filter to set bit 3 to "1" causes bit 3 of the event register to be set to "1"; when bit 3 of the condition register makes a negative transition, it changes from 1 to 0.

Transition filter and condition register

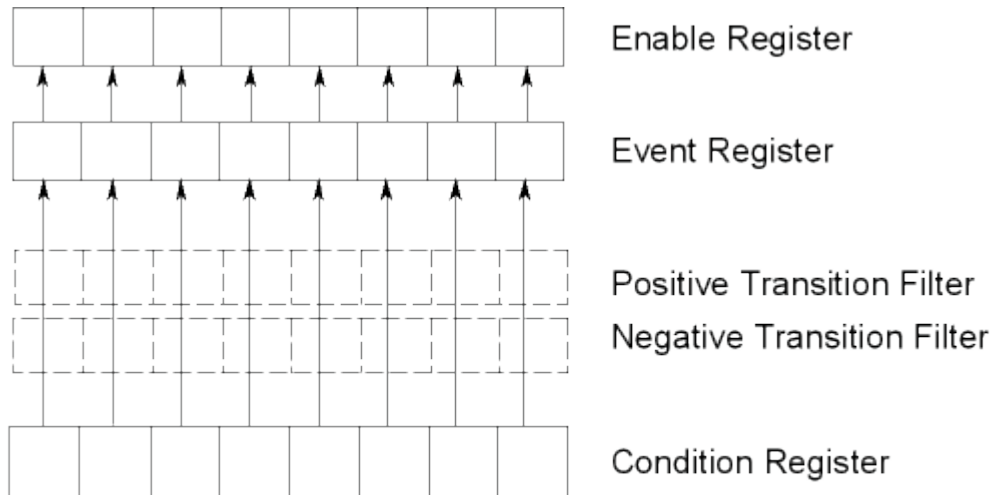

4294ape022

In the E4990A, the following registers provide a condition register and transition filter:

- Operation status register
- Questionable status register
- Questionable limit status register
- Questionable limit channel/trace status registers

Commands for the Status Reporting System

You can manage the status report system using the following commands in any combination:

- *CLS
- *SRE
- *STB?
- *ESE
- *ESR?
- :STAT:PRES
- :STAT:OPER:ENAB
- :STAT:OPER:COND?
- :STAT:OPER?
- :STAT:OPER:PTR
- :STAT:OPER:NTR
- :STAT:QUES:ENAB
- :STAT:QUES:COND?

E4990A Impedance Analyzer Help

- [:STAT:QUES?](#)
- [:STAT:QUES:PTR](#)
- [:STAT:QUES:NTR](#)
- [:STAT:QUES:LIM:ENAB](#)
- [:STAT:QUES:LIM:COND?](#)
- [:STAT:QUES:LIM?](#)
- [:STAT:QUES:LIM:PTR](#)
- [:STAT:QUES:LIM:NTR](#)
- [:STAT:QUES:LIM:CHAN<ch>:COND?](#)
- [:STAT:QUES:LIM:CHAN<ch>:ENAB](#)
- [:STAT:QUES:LIM:CHAN<ch>?](#)
- [:STAT:QUES:LIM:CHAN<ch>:PTR](#)
- [:STAT:QUES:LIM:CHAN<ch>:NTR](#)

Status Register Structure

Status Register Structure

- [Status Register](#)
- [Status Register for Limit Test \(Channel\)](#)
- [Status Register for Limit Test \(Trace\)](#)

Status Register

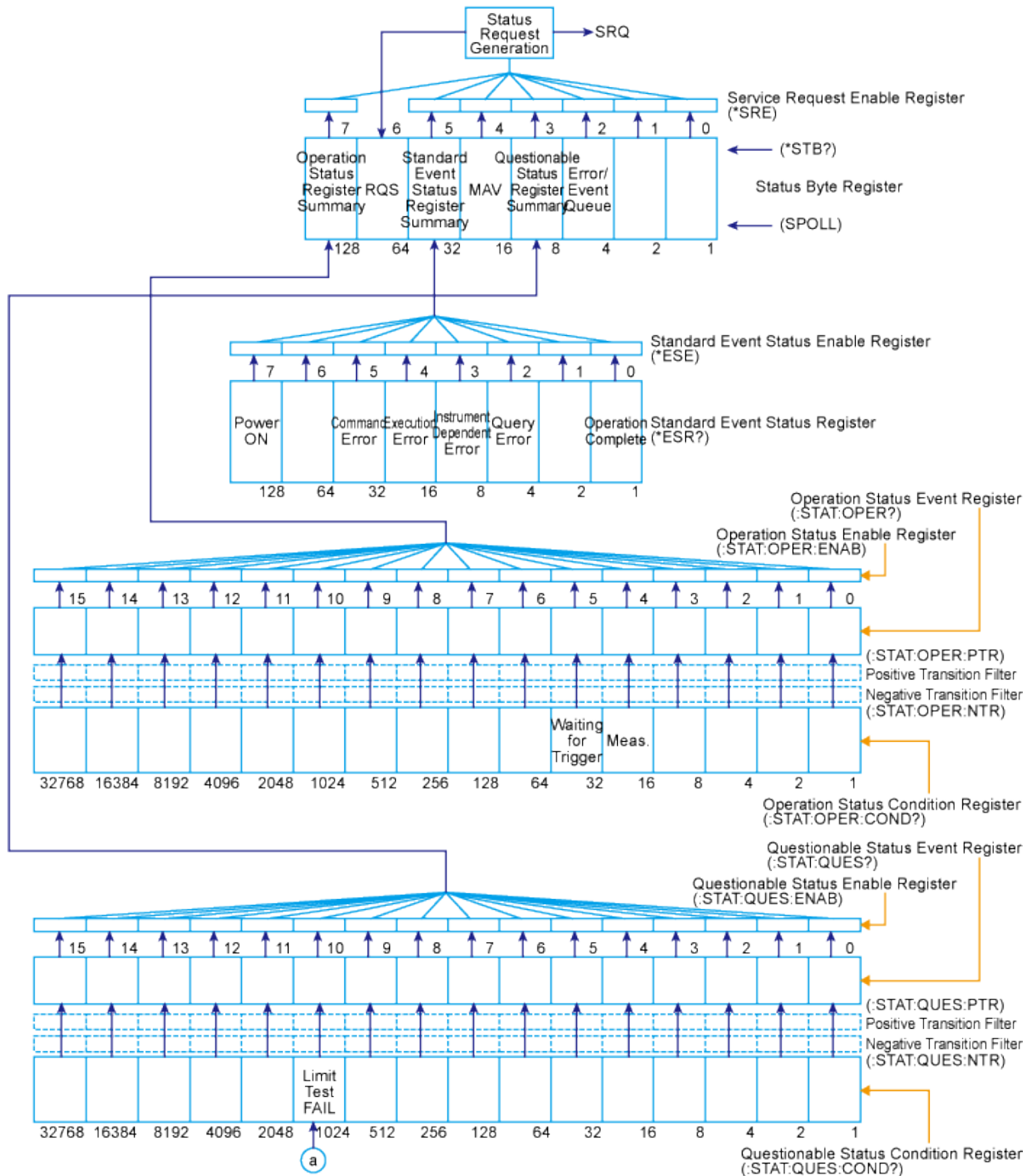

e4990a101

Status Bit Definitions of Status Byte Register

Bit Position	Name	Description
--------------	------	-------------

E4990A Impedance Analyzer Help

0, 1	Not used	Always 0
2	Error/Event Queue	Set to "1" if the error/event queue contains data; reset to "0" when all the data has been retrieved.
3	Questionable Status Register Summary	Set to "1" when one of the enabled bits in the questionable status register is set to "1."
4	MAV (Message Available)	Set to "1" when the output queue contains data; reset to "0" when all the data has been retrieved.
5	Standard Event Status Register Summary	Set to "1" when one of the enabled bits in the standard event status register is set to "1."
6	RQS	Set to "1" when any of the status byte register bits enabled by the service request enable register is set to "1"; reset to "0" when all the data has been retrieved through serial polling.
7	Operation Status Register Summary	Set to "1" when one of the enabled bits in the operational status register is set to "1."

Issuing the ***CLS** command clears all bits from the status byte register.

Status Bit Definitions of Standard Event Status Register

Bit Position	Name	Description
0	Operation Complete	Set to "1" upon completion of all operations done by commands that precede the *OPC? command.
1	Not used	Always 0
2	Query Error	<ol style="list-style-type: none"> Set to "1" when the E4990A receives a data output request but there is no data to output. Set to "1" when the data of the E4990A's output queue has been cleared

		because of a new message received before the completion of data output.
3	Instrument Dependent Error	Set to "1" when an error has occurred and the error is not a command, query, or execution error.
4	Execution Error	<ol style="list-style-type: none"> 1. Set to "1" when any parameter in an SCPI command exceeds its input range or is inconsistent with the E4990A's capabilities. 2. Set to "1" when an SCPI command cannot be properly executed due to some condition of the E4990A.
5	Command Error	<ol style="list-style-type: none"> 1. Set to "1" when an IEEE 488.2 syntax error occurs (a command sent to the E4990A does not follow the IEEE 488.2 syntax). Possible violations include the command parameter violating the E4990A listening formats or being unacceptable. 2. Set to "1" when a semantic error occurs. Possible causes include a command containing misspellings being sent to the E4990A or an IEEE 488.2 command not supported by the E4990A being sent. 3. Set to "1" when GET (Group Execution Trigger) is input while a program message is being received.
6	Not used	Always 0
7	Power ON	Set to "1" when the E4990A is powered ON, or when the firmware is restarted.

Issuing the ***CLS** command clears all bits from the standard event status register.

Status Bit Definitions of the Operation Status Condition Register

Bit Position	Name	Description
---------------------	-------------	--------------------

E4990A Impedance Analyzer Help

0 - 3	Not used	Always 0
4	Measurement	Set to "1" during measurement
5	Waiting for Trigger	Set to "1" while the instrument is waiting for a trigger.
6 - 15	Not used	Always 0

Issuing the ***CLS** command clears all bits from the operation status event register.

Status Bit Definitions of the Questionable Status Condition Register

Bit Position	Name	Description
0 - 9	Not used	Always 0
10	Limit Test Fail (Questionable limit status register summary)	Set to "1" while one of the enabled bits in the questionable limit status event register is set to "1."
11 - 15	Not used	Always 0

Status Bit Definitions of the Questionable Status Event Register

Bit Position	Name	Description
0 - 9	Not used	Always 0
10	Limit Test Fail (Questionable limit status register summary)	Set to "1" when a transition of the condition register occurs if the transition filters are set as valid values.
11 - 15	Not used	Always 0

Issuing the ***CLS** command clears all bits from the questionable status event register.

[Status Register for Limit Test \(channel\)](#)

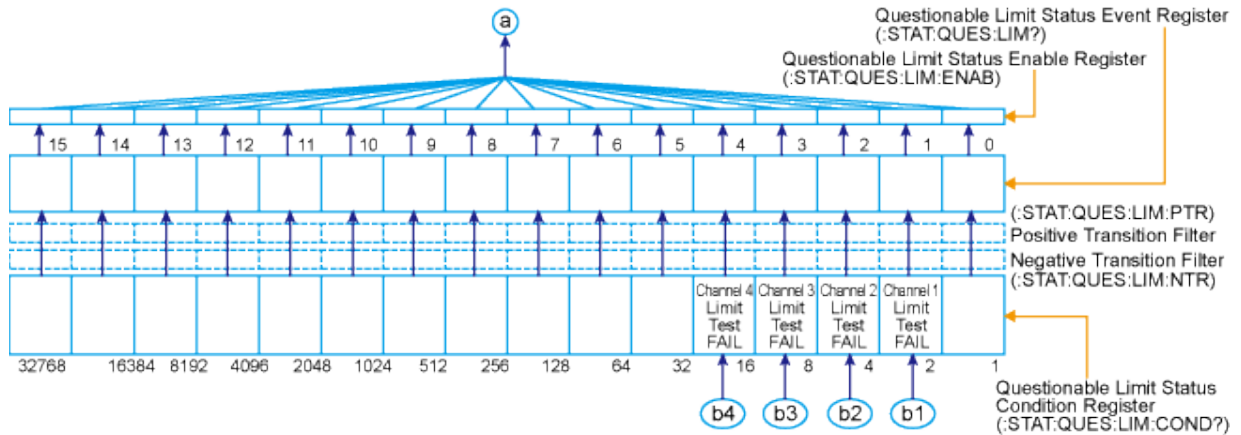

e5061b015

Status Bit Definitions of the Questionable Limit Status Condition Register

Bit Position	Name	Description
0	Not used	Always 0
1	Channel 1 Limit Test Fail (questionable limit channel 1 status register summary)	Set to "1" while one of the enabled bits in the questionable limit channel 1 status event register is set to "1."
2	Channel 2 Limit Test Fail (questionable limit channel 2 status register summary)	Set to "1" while one of the enabled bits in the questionable limit channel 2 status event register is set to "1."
3	Channel 3 Limit Test Fail (questionable limit channel 3 status register summary)	Set to "1" while one of the enabled bits in the questionable limit channel 3 status event register is set to "1."
4	Channel 4 Limit Test Fail (questionable limit channel 4 status register summary)	Set to "1" while one of the enabled bits in the questionable limit channel 4 status event register is set to "1."

E4990A Impedance Analyzer Help

	summary)	"1."
5 to 15	Not used	Always 0

Issuing the ***CLS** command clears all bits from the questionable limit status event register.

Status Register for Limit Test (Trace)

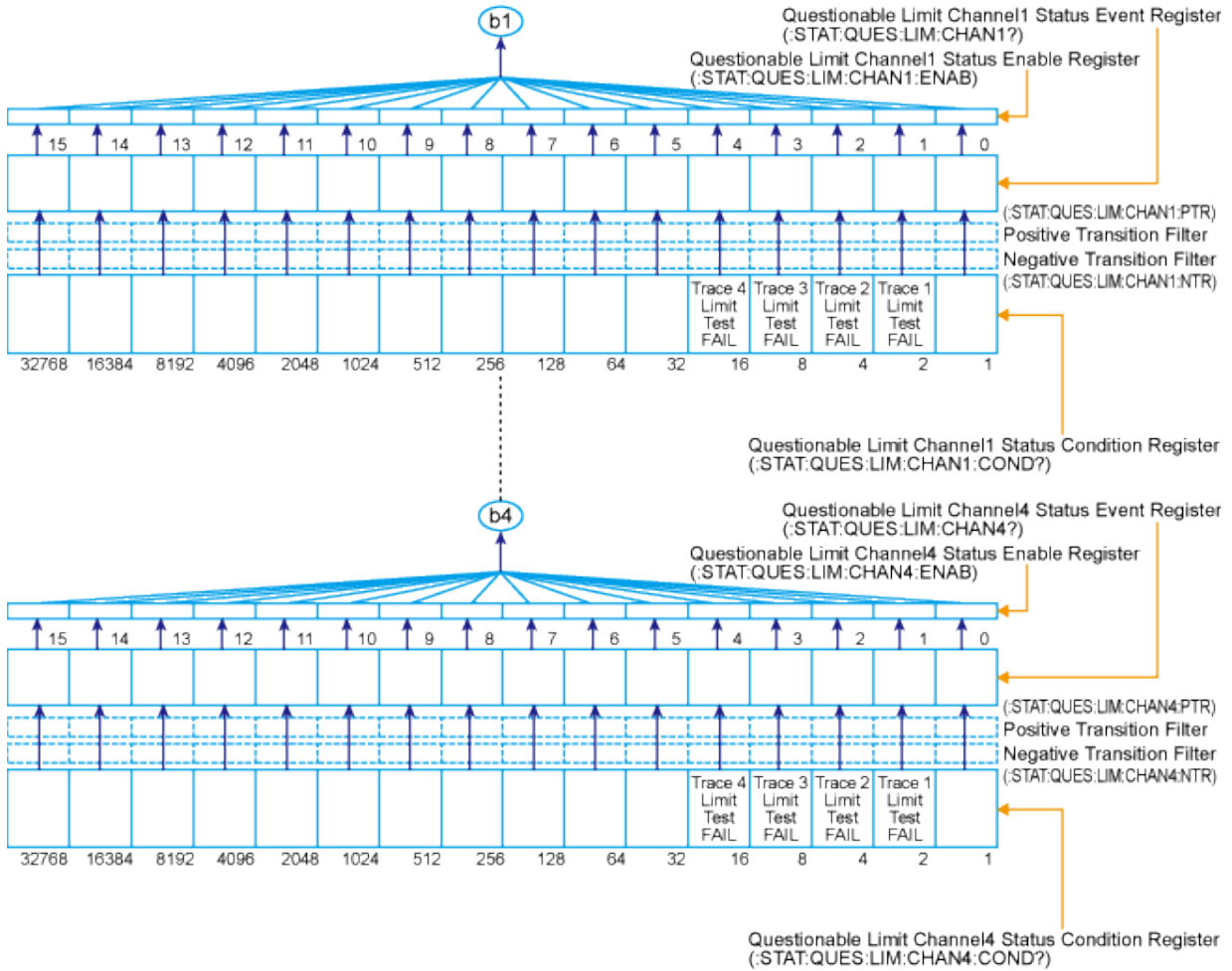

e5061b016

Status Bit Definitions of the Questionable Limit Channel Status Condition Register

Bit Position	Name	Description
--------------	------	-------------

0	Not used	Always 0
1	Trace 1 Limit Test Fail	Set to "0" when a measurement cycle begins; set to "1" when the measurement cycle finishes and returns "fail" as the limit test result for trace 1.
2	Trace 2 Limit Test Fail	Set to "0" when a measurement cycle begins; set to "1" when the measurement cycle finishes and returns "fail" as the limit test result for trace 2.
3	Trace 3 Limit Test Fail	Set to "0" when a measurement cycle begins; set to "1" when the measurement cycle finishes and returns "fail" as the limit test result for trace 3.
4	Trace 4 Limit Test Fail	Set to "0" when a measurement cycle begins; set to "1" when the measurement cycle finishes and returns "fail" as the limit test result for trace 4.
5 to 15	Not used	Always 0

Issuing the *CLS command clears all the bits in the questionable limit channel status event register.

Using Macro

Using Macro

- [Overview](#)
- [Reading Data](#)
- [Using Echo Window](#)
- [Using User Menu](#)
- [Using Form](#)

Overview

- [Macro Using COM](#)
- [Executing Macro from Softkey/Hardkey](#)

- [Using User Menu Function](#)

[Other topics about Using Macro](#)

Macro Using COM

When you want to control the E4990A internally, you can use COM objects alone or in conjunction with SCPI commands and the Parse object. The latter method is a little slower than the former method because the Parse object is used to parse the messages of SCPI commands.

Example: Using COM object

```
Dim Ana
set Ana = CreateObject("E4990.Application")
Ana.scpi.display.split = "D12_34"
Ana.scpi.display.window(2).activate
```

Example: In conjunction with SCPI commands and the Parse object

```
Dim Ana
set Ana = CreateObject("E4990.Application")
Ana.parse "DISP:SPLIT D12_34"
Ana.parse "DISP:WIND2:ACT"
```

You can use this with VB Script. If you install the Excel (Excel VBA) or other programmable software in the E4990A, It also can control the E4990A.

Executing Macro from Softkey/Hardkey

Macros are executable programs that you write, load into the analyzer, and then run from the analyzer. Macros (.vbs and .exe) can be executed by clicking its file on the file explore. However, you can execute it from Softkey or Hardkey. You can have up to 25 macros set up to run on the analyzer.

Registering your macro

1. Press **Macro Setup** > **Macro Setup ...** .
2. Click **Edit** to start the **Edit Macro Setup** dialog.
3. In the **Macro Title box**, type a descriptive title for your macro.
4. Click **Browse**.
5. Find and select your executable file. Change Files of Type if necessary.
6. Click **OK** on the **Edit Macro Setup** dialog.
7. Change the order by **Up** or **Down** keys as necessary.

8. Click **OK** on the Macro Setup dialog.

Executing Macro by Soft key

1. Press **Macro Menu**, then registered macro is listed in the softkey.
2. Click the desired softkey to run the macro.

Executing Macro by Hard key

- Pressing **Macro Run** executes the macro which is registered at the top of list.

Using User Menu Function

The E4990A lets you perform procedures assigned to specific softkeys (**Macro Setup** > **User Menu** > **Button 1** to **Button 10**), without using user forms, when that softkey is pressed. This function is called the user menu function.

To execute a procedure assigned to a softkey, you need to generate an event of pressing the softkey.

Refer to [Using User Menu](#).

Reading Data

- [Overview](#)
- [Sample Program](#)

[Other topics about Using Macro](#)

Overview

This sample program demonstrates how to save the formatted data arrays in csv file (Result.csv)

1. Copy the following code into a Notepad file.
2. Save the file on the analyzer storage in the D: folder. Name the file as "readingData.vbs".
3. Double-click the file to execute.

Sample Program

```
On Error Resume Next
Dim ana
Dim Result
Dim Freq
Dim StrTemp
Dim objFSO
Dim objFile
Set ana = CreateObject("E4990.Application")
```

E4990A Impedance Analyzer Help

```
ana.parse ":CALC1:PAR1:SEL"  
ana.parse ":INIT1:CONT OFF"  
ana.parse ":ABOR"  
NoOfPoint = ana.parse(":SENS1:SWE:POIN?")  
StrTemp = ana.parse(":SENS1:FREQ:DATA?")  
Freq = Split(StrTemp, ",")  
StrTemp = ana.parse(":CALC1:DATA:FDAT?")  
Result = Split(StrTemp, ",")  
Set objFSO = WScript.CreateObject("Scripting.FileSystemObject")  
If Err.Number = 0 Then  
    Set objFile = objFSO.OpenTextFile("Result.csv", 2, True)  
    If Err.Number = 0 Then  
j = 0  
        For i = 1 To NoOfPoint  
            objFile.WriteLine(Freq(i-1)&" , "&Result(j)&" , "&Result(j+1))  
                j = j + 2  
        Next  
        objFile.Close  
    Else  
        WScript.Echo "File Open Error: " & Err.Description  
    End If  
Else  
    WScript.Echo "Error: " & Err.Description  
End If  
Set objFile = Nothing  
Set objFSO = Nothing
```

Using Echo Window

- [Overview](#)
- [Sample Program](#)

[Other topics about Using Macro](#)

Overview

This sample program demonstrates the following operation.

1. Activate Marker 1.
2. Search Max point.
3. Display the marker value in the echo window.

To use this sample:

1. Copy the following code into a Notepad file.
2. Save the file on the analyzer storage in the D: folder. Name the file as "echoMarker.vbs"
3. Double-click the file to execute.

Sample Program

```
dim ana
set ana = CreateObject("E4990.Application")
ana.scpi.display.table.state = true
ana.scpi.display.table.type = "echo"
ana.scpi.display.echo.clear
ana.scpi.calculate.selected.marker(1).state = true
ana.scpi.calculate.selected.marker(1).activate
ana.scpi.calculate.selected.marker(1).function.type = "maximum"
ana.scpi.calculate.selected.marker(1).function.execute
axisx = ana.scpi.calculate.selected.marker(1).x.data
axisy = ana.scpi.calculate.selected.marker(1).y
ana.scpi.display.echo.data = cstr(axisx)
ana.scpi.display.echo.data = cstr(axisy(0))
```

Using User Menu

- [Overview](#)
- [Sample Program](#)

[Other topics about Using Macro](#)

Overview

This sample program demonstrates the following operation.

1. Set the softkey label of user menu (**Macro Setup > User Menu**).
2. When user menu softkey is pressed, the [Sub UserMenuButton_OnPress\(bNo\)](#) is executed with the key number.
3. The marker is operated according to the key number.

To use this sample:

1. Copy the following code into a Notepad file.
2. Save the file on the analyzer storage in the D: folder. Name the file as "userMenu.vbs".
3. Double-click the file to execute.

Sample Program

```
dim ana
```

E4990A Impedance Analyzer Help

```
dim userMenu
dim bNo
dim mkrNo
set userMenu = WScript.CreateObject("E4990.UserMenu", "UserMenuButton_")
set ana = CreateObject("E4990.Application")
for bNo=1 to 5
    select case bNo
    case 1, 2, 3
        UserMenu.item(cint(bNo)).caption = "Marker" & bNo
    case 4
        UserMenu.item(cint(bNo)).caption = "Max"
    case 5
        UserMenu.item(cint(bNo)).caption = "Min"
    end select
next
Do Until False
    WScript.Sleep 500
Loop
Sub UserMenuButton_OnPress(bNo)
    Select case bNo

    case 1, 2, 3
        mkrNo=bNo
        ana.scpi.calculate.selected.marker(mkrNo).state = true
        ana.scpi.calculate.selected.marker(mkrNo).activate
    case 4
        ana.scpi.calculate.selected.marker(mkrNo).function.type = "maximum"
        ana.scpi.calculate.selected.marker(mkrNo).function.execute
    case 5
        ana.scpi.calculate.selected.marker(mkrNo).function.type = "minimum"
        ana.scpi.calculate.selected.marker(mkrNo).function.execute
    end select
End Sub
```

Using Form

- [Overview](#)
- [Sample Program](#)

[Other topics about Using Macro](#)

Overview

HTML Applications (HTAs) allows you to use a form with VB script.

This sample program demonstrates the following operation.

- Pressing "Marker 1 => Max" moves the marker 1 at maximum point, then display the x and y value.
- Pressing "Marker 2 => Min" moves the marker 2 at minimum point, then display the x and y value.

To use this sample:

1. Copy the following code into a Notepad file.
2. Save the file on the analyzer storage in the D: folder. Name the file as "form.hta".
3. Double-click the file to execute.

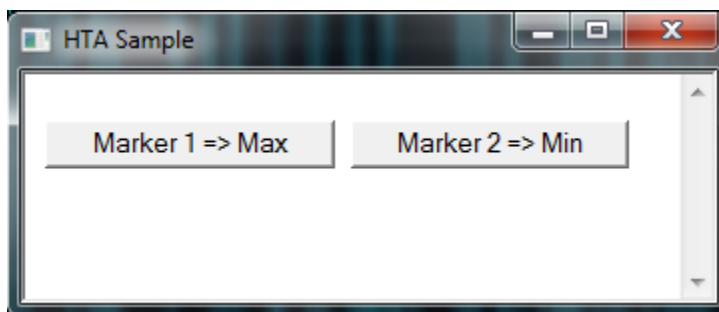
**Sample Program**

```

<html><head>
<title>HTA Sample</title>
<script language="VBScript">
  set ana = CreateObject("E4990.Application")
  ana.scpi.system.preset
  ana.scpi.initiate(1).continuous = false
  Sub Window_OnLoad
    Window.ResizeTo 500,200
  End Sub
  Sub max()
    ana.scpi.calculate(1).selected.marker(1).state = true
    ana.scpi.calculate(1).selected.marker(1).function.type="maximum"
    ana.scpi.calculate(1).selected.MARKer(1).FUNCTION.EXECute
    axisx = ana.scpi.calculate(1).selected.marker(1).x.data
    axisy = ana.scpi.calculate(1).selected.marker(1).y
    DataArea1.InnerHTML = cstr(axisx)
    DataArea2.InnerHTML = cstr(axisy(0))
  End Sub
</script>

```

E4990A Impedance Analyzer Help

End Sub

Sub min()

```
ana.scpi.calculate(1).selected.marker(2).state = true
```

```
ana.scpi.calculate(1).selected.marker(2).function.type="minimum"
```

```
ana.scpi.calculate(1).selected.MARKer(2).FUNCTION.EXECute
```

```
axisx = ana.scpi.calculate(1).selected.marker(2).x.data
```

```
axisy = ana.scpi.calculate(1).selected.marker(2).y
```

```
DataArea1.InnerHTML = cstr(axisx)
```

```
DataArea2.InnerHTML = cstr(axisy(0))
```

End Sub

</script>

</head>

<body>

```
<form name="form1" style="font-size:24pt">
```

```
<input type="button" value="Marker 1 => Max" onClick="max()" />
```

```
<input type="button" value="Marker 2 => Min" onClick="min()" />
```

<p>

Command Reference

Command Reference

- [Notational Conventions](#)
- Command Finder
 - Analysis
 - Average
 - Calibration
 - Display
 - Format
 - Marker
 - Marker Function
 - Marker Search
 - Meas
 - Preset
 - Save/Recall

- Scale
- Stimulus
- System
- Trigger

Notational Conventions

This section describes the notational conventions used for the description of commands reference.

Type

- Command/Query
- Command
- Query

Syntax

The part with heading "Syntax" describes the syntax used to send a command from the external controller to the E4990A. A syntax consists of a command part and a parameter part. The separator between these parts is a space.

If there are several parameters, the separator between adjacent parameters is a comma (,). Ellipsis (...) between commas indicates that parameters in that part are omitted. For example, <numeric 1>, ..., <numeric 4> indicates that 4 parameters, <numeric 1>, <numeric 2>, <numeric 3>, <numeric 4>, are required.

String-type parameters, <string>, <string 1>, and so on, must be enclosed in double quotation marks ("). <block> shows block format data.

You can omit the lowercase letters in syntax. For example, ":CALibration: CABLE" can be shortened as ":CAL: CABL."

The definition of symbols used in the syntax is as follows:

<>	Characters enclosed in this pair of symbols are necessary parameters when sending the command.
[]	Part enclosed in this parenthesis pair can be omitted.
{ }	Part enclosed in this parenthesis pair indicates that you must select one of the items in this part. Individual items are separated by a vertical bar ().

For example, ":CALC:CORR:EDEL:TIME 0.1"
 ,":CALCULATE1:SELECTED:CORR:EDEL:TIME 25E-3," and so on are valid
 for the syntax given below.

:CALCulate<ch>[:SELEcted]:CORRection:EDElay:TIME <numeric>

Description

Part with heading "Description" describes how to use the command or the operation when executed.

Variable

Part with heading "Variable" describes necessary parameters when sending the command. When a parameter is a value type or a string type enclosed with <>, its description, allowable setup range, preset (factory-set) value, and so on are given; when a parameter is a selection type enclosed with { }, the description of each selection item is

Query Response

Part with heading "Query response" describes the data format read out when query (reading out data) is available with the command.

Each readout parameter is enclosed with { }. If there are several items within { } separated by the pipe (|), only one of them is read out.

When several parameters are read out, they are separated with a comma (,). Note that, 3 points (...) between commas indicate that the data of that part is omitted. For example, {numeric 1},...,{numeric 4} indicates that 4 data items, {numeric 1}, {numeric 2}, {numeric 3}, and {numeric 4}, are read out.

<newline><^END> after the parameters is the program message terminator.

Examples

Examples provide a sample coding with VISA-COM.

As per most programming practice, its up to the user to define any variable name for the instrument. Once defined, the variable is used throughout the

program. In the examples provided, several variable names are used, as below:

Ana

Analyzer

Related Command

Related command provides information about other command that are similar/related with the command.

Equivalent Key

Equivalent key shows the operational procedure of the front panel keys that has the same effect as this command.

COM Command Syntax (Internal Control Only)

COM command syntax shows the command to execute using COM such as internal VB script or Visual Basic/Excel VBA which is installed in the E4990A.

ABORT

:ABOR

Type

Command

Syntax

:ABORt

Description

This command aborts the current sweep.

Examples

Ana.WriteString ":ABOR", True

Related Commands

[:TRIG](#)

[:TRIG:SING](#)

Equivalent Softkey

Trigger > **Restart**

COM Command Syntax (Internal Control Only)

SCPI.ABORT

CALCULATE

:CALC<Ch>:AVER

Type

Command/Query

E4990A Impedance Analyzer Help

Syntax

:CALCulate<Ch>:AVERage[:STATe] {ON|OFF|1|0}

:CALCulate<Ch>:AVERage[:STATe]?

Description

This command sets/gets the averaging state.

Variable

Parameter	Selection Option
Description	Averaging state
Data Type	Boolean type (Boolean)
Range	ON OFF 1 0
Preset Value	OFF

Query Response

{1|0} <newline> < ^END>

Examples

```
Dim Var as Integer
Ana.WriteString ":CALC1:AVER ON", True
Ana.WriteString ":CALC1:AVER?", True
Var=Ana.ReadNumber
```

Related Commands

[:CALC:AVER:CLE](#)

[:CALC:AVER:COUN](#)

Equivalent Softkey

Average > **Averaging**

COM Command Syntax (Internal Control Only)

SCPI.CALCULATE(Ch).AVERAGE.STATE

:CALC<Ch>:AVER:CLE

Type

Command

Syntax

:CALCulate<Ch>:AVERage:CLEar

Description

This command clears averaging count.

Examples

```
Ana.WriteString ":CALC1:AVER:CLE", True
```

Related Commands

[:CALC:AVER](#)

[:CALC:AVER:COUN](#)

Equivalent Softkey

Average > **Averaging Restart**

COM Command Syntax (Internal Control Only)

```
SCPI.CALCULATE(Ch).AVERAGE.CLEAR
```

:CALC<Ch>:AVER:COUN

Type

Command/Query

Syntax

```
:CALCulate<Ch>:AVERage:COUNT <Value>
```

```
:CALCulate<Ch>:AVERage:COUNT?
```

Description

This command sets/gets the averaging count.

Variable

Parameter	Value
Description	averaging factor
Data Type	Numeric type (Integer)
Range	1 ~ 999
Preset Value	16

Query Response

```
{numeric} <newline> < ^END >
```

Examples

```
Dim Var as Long
Var= 10
Ana.WriteString ":CALC1:AVER:COUN " & Str(Var), True
Ana.WriteString ":CALC1:AVER:COUN?", True
Var=Ana.ReadNumber
```

Related Commands

[:CALC:AVER](#)

[:CALC:AVER:CLE](#)

Equivalent Softkey

Average > **Avg Factor**

COM Command Syntax (Internal Control Only)

SCPI.CALCULATE(Ch).AVERAGE.COUNT

:CALC<Ch>:DATA:FDAT

Type

Command/Query

Syntax

:CALCulate<Ch>[:SElected]:DATA:FDATa <Value>

:CALCulate<Ch>[:SElected]:DATA:FDATa?

Description

This command sets/gets the formatted data array.

The array data element varies in the data format. If valid data is not calculated because of the invalid measurement, "1.#QNB" is read out.

Variable

Parameter	Value
Description	<p>Formatted data array</p> <p>Where n is an integer between 1 and NOP (number of measurement points):</p> <ul style="list-style-type: none"> <numeric n×2-1>: Real part of data (complex number) at the n-th measurement point. <numeric n×2>: Imaginary part of data (complex number) at the n-th measurement point. Always 0 when the data format is not the Smith chart format or the polar format <p>The number of data is {NOP×2}</p>
Data Type	Variant type Array (Range)
Note	If there is no array data of NOP×2 when setting a formatted data array, an error occurs when executed.

Query Response

{numeric 1}, ..., {numeric NOP×2} <newline> <^END>

Examples

See Reading/Writing Data.

Related Commands[:CALC:DATA:FMEM](#)[:CALC:DATA:RDAT](#)[:CALC:DATA:RMEM](#)**Equivalent Softkey**

No equivalent key is available on the front panel.

COM Command Syntax (Internal Control Only)

```
SCPI.CALCULATE(Ch).SELECTED.DATA.FDATA
```

```
:CALC<Ch>:DATA:FMEM
```

Type

Command/Query

Syntax

```
:CALCulate<Ch>[:SELEcted]:DATA:FMEMory <Value>
```

```
:CALCulate<Ch>[:SELEcted]:DATA:FMEMory?
```

Description

This command sets/gets the formatted memory array.

The array data element varies in the data format. If valid data is not calculated because of the invalid measurement, "1.#QNB" is read out.

Variable

Parameter	Value
Description	Formatted memory array Where n is an integer between 1 and NOP (number of measurement points): <ul style="list-style-type: none"> • <numeric n×2-1>: Real part of data (complex number) at the n-th measurement point. • <numeric n×2>: Imaginary part of data (complex number) at the n-th measurement point. Always 0 when the data format is not the Smith chart format or the polar format The number of data is {NOP×2}
Data Type	Variant type Array (Range)
Note	If there is no array data of NOP×2 when setting a formatted data array, an error occurs when executed.

E4990A Impedance Analyzer Help

Query Response

{numeric 1}, ..., {numeric NOP×2} <newline> <^END>

Examples

See [:CALC:DATA:FDAT](#)

Related Commands

[:CALC:DATA:FDAT](#)

[:CALC:DATA:RDAT](#)

[:CALC:DATA:RMEM](#)

Equivalent Softkey

No equivalent key is available on the front panel.

COM Command Syntax (Internal Control Only)

SCPI.CALCULATE(Ch).SELECTED.DATA.FMEMORY

:CALC<Ch>:DATA:RDAT

Type

Command/Query

Syntax

:CALCulate<Ch>[:SElected]:DATA:RDATa <Value>

:CALCulate<Ch>[:SElected]:DATA:RDATa?

Description

This command sets/gets the raw data. Save/Recall valid when MMEM:STOR:STYPE = [DState|CDState]

Variable

Parameter	Value
Description	<p>raw data array</p> <p>Where n is an integer between 1 and NOP (number of measurement points):</p> <ul style="list-style-type: none">• <numeric n×2-1>: Real part of data (complex number) at the n-th measurement point.• <numeric n×2>: Imaginary part of data (complex number) at the n-th measurement point. Always 0 when the data format is not the Smith chart format or the polar format <p>The number of data is {NOP×2}</p>
Data Type	Variant type Array (Range)

Note

If there is no array data of $\text{NOP} \times 2$ when setting a formatted data array, an error occurs when executed.

Query Response

{numeric 1}, ..., {numeric $\text{NOP} \times 2$ } <newline> <^END>

Examples

See [:CALC:DATA:FDAT](#)

Related Commands

[:CALC:DATA:FDAT](#)

[:CALC:DATA:FMEM](#)

[:CALC:DATA:RMEM](#)

Equivalent Softkey

No equivalent key is available on the front panel.

COM Command Syntax (Internal Control Only)

SCPI.CALCULATE(Ch).SELECTED.DATA.RDATA

:CALC<Ch>:DATA:RMEM

Type

Command/Query

Syntax

:CALCulate<Ch>[:SElected]:DATA:RMEMory <Value>

:CALCulate<Ch>[:SElected]:DATA:RMEMory?

Description

This command sets/gets raw memory data. Save/Recall valid when $\text{MMEM:STOR:STYPE} = [\text{DState}|\text{CDState}]$.

Variable

Parameter	Value
Description	<p>raw memory array</p> <p>Where n is an integer between 1 and NOP (number of measurement points):</p> <ul style="list-style-type: none"> • <numeric $n \times 2 - 1$>: Real part of data (complex number) at the n-th measurement point. • <numeric $n \times 2$>: Imaginary part of data (complex number) at the n-th measurement point. Always 0 when the data format is not the Smith chart format or the polar format

E4990A Impedance Analyzer Help

	The number of data is {NOP×2}
Data Type	Variant type Array (Range)
Note	If there is no array data of NOP×2 when setting a formatted data array, an error occurs when executed.

Query Response

{numeric 1}, ..., {numeric NOP×2} <newline> < ^END >

Examples

See [:CALC:DATA:FDAT](#)

Related Commands

[:CALC:DATA:RDAT](#)

[:CALC:DATA:FDAT](#)

[:CALC:DATA:FMEM](#)

Equivalent Softkey

No equivalent key is available on the front panel.

COM Command Syntax (Internal Control Only)

SCPI.CALCULATE(Ch).SELECTED.DATA.RMEMORY

:CALC<Ch>:DATA:XAX

Type

Query

Syntax

:CALCulate<Ch>[:SElected]:DATA:XAXis?

Description

This command returns the data of measurement points of X axis.

Variable

Query Response

{numeric 1} ... {numeric NOP} <newline> < ^END >

Examples

```
Dim Var as Variant
Ana.WriteString ":CALC1:DATA:XAX?", True
Var=Ana.ReadList(ASCIIType_R8, ",")
```

Related Commands

[:SENS:FREQ:DATA](#)

Equivalent Softkey

No equivalent key is available on the front panel.

COM Command Syntax (Internal Control Only)

```
SCPI.CALCULATE(Ch).SELECTED.DATA.XAXIS
```

```
:CALC<Ch>:EPAR
```

Type

Command

Syntax

```
:CALCulate<Ch>:EPARameters[: EXECute]
```

Description

This command executes the equivalent circuit analysis in the selected equivalent circuit model. Executes the equivalent circuit analysis in the partial search range.

Examples

```
Ana.WriteString ":CALC1:EPAR", True
```

Related Commands

[:CALC:EPAR:CIRC](#)

Equivalent Softkey

Analysis > Equivalent Circuit > Calculate

COM Command Syntax (Internal Control Only)

```
SCPI.CALCULATE(Ch).EPARAMETERS.EXECUTE
```

```
:CALC<Ch>:EPAR:CIRC
```

Type

Command/Query

Syntax

```
:CALCulate<Ch>:EPARameters:CIRCuit[: TYPE] {A|B|C|D|E|F|G}
```

```
:CALCulate<Ch>:EPARameters:CIRCuit[: TYPE]?
```

Description

This command selects the equivalent circuit model.

Variable

Parameter	Selection Option
Description	Equivalent circuit model
Data Type	Character string type (String)
Range	A B C D E F G
Preset Value	A

E4990A Impedance Analyzer Help

Query Response

{A|B|C|D|E|F|G} <newline> < ^END>

Examples

```
Dim Var as String
Var= "A"
Ana.WriteString ":CALC1:EPAR:CIRC " & Var, True
Ana.WriteString ":CALC1:EPAR:CIRC?", True
Var=Ana.ReadString
```

Related Commands

[:CALC:EPAR](#)
[:CALC:EPAR:CIRC:{A|B|C|D|E|F|G}:C0](#)
[:CALC:EPAR:CIRC:{A|B|C|D|E|F|G}:C1](#)
[:CALC:EPAR:CIRC:{A|B|C|D|E|F|G}:L1](#)
[:CALC:EPAR:CIRC:{A|B|C|D|E|F|G}:R0](#)
[:CALC:EPAR:CIRC:{A|B|C|D|E|F|G}:R1](#)
[:CALC:EPAR:DISP](#)

Equivalent Softkey

Analysis > **Equivalent Circuit** > **Select Circuit** > **A to G**

COM Command Syntax (Internal Control Only)

SCPI.CALCULATE(Ch).EPARAMETERS.CIRCUIT.TYPE

:CALC<Ch>:EPAR:CIRC:{A|B|C|D|E|F|G}:C1

Type

Command/Query

Syntax

:CALCulate<Ch>:EPARameters:CIRCuit:{A|B|C|D|E|F|G}:C1 <Value>

:CALCulate<Ch>:EPARameters:CIRCuit:{A|B|C|D|E|F|G}:C1?

Description

This command sets/gets C1 value of equivalent circuit parameters

Variable

Parameter	Value
Description	C1 value
Data Type	Numeric type (Real)
Range	-1E ~ 1E

Preset Value	0
Unit	F
Resolution	-

Query Response

{ numeric } <newline> < ^END >

Examples

```
Dim Var as Double
Var= 0.0001
Ana.WriteString ":CALC1:EPAR:CIRC:A:C1 " & Str(Var), True
Ana.WriteString ":CALC1:EPAR:CIRC:A:C1?", True
Var=Ana.ReadNumber
```

Related Commands

[:CALC:EPAR:CIRC](#)

Equivalent Softkey

Analysis > Equivalent Circuit > C1

COM Command Syntax (Internal Control Only)

SCPI.CALCULATE(Ch).EPARAMETERS.CIRCUIT.{A|B|C|D|E|F|G}.C1

:CALC<Ch>:EPAR:CIRC:{A|B|C|D|E|F|G}:L1

Type

Command/Query

Syntax

:CALCulate<Ch>:EPARameters:CIRCuit: {A|B|C|D|E|F|G}:L1 <Value>

:CALCulate<Ch>:EPARameters:CIRCuit: {A|B|C|D|E|F|G}:L1?

Description

This command sets/gets L1 value of equivalent circuit parameters

Variable

Parameter	Value
Description	L1 value
Data Type	Numeric type (Real)
Range	-1E ~ 1E

E4990A Impedance Analyzer Help

Preset Value	0
Unit	H
Resolution	-

Query Response

{ numeric } <newline> < ^END>

Examples

```
Dim Var as Double
Var= 0.0001
Ana.WriteString ":CALC1:EPAR:CIRC:A:L1 " & Str(Var), True
Ana.WriteString ":CALC1:EPAR:CIRC:A:L1?", True
Var=Ana.ReadNumber
```

Related Commands

[:CALC:EPAR:CIRC](#)

Equivalent Softkey

Analysis > Equivalent Circuit > L1

COM Command Syntax (Internal Control Only)

SCPI.CALCULATE(Ch).EPARAMETERS.CIRCUIT.{A|B|C|D|E|F|G}.L1

:CALC<Ch>:EPAR:CIRC:{A|B|C|D|E|F|G}:R1

Type

Command/Query

Syntax

:CALCulate<Ch>:EPARameters:CIRCuit: {A|B|C|D|E|F|G}:R1 <Value>

:CALCulate<Ch>:EPARameters:CIRCuit: {A|B|C|D|E|F|G}:R1?

Description

This command sets/gets R1 value of equivalent circuit parameters

Variable

Parameter	Value
Description	R1 value
Data Type	Numeric type (Real)
Range	-1E ~ 1E

Preset Value	0
Unit	Ω
Resolution	-

Query Response

{numeric} <newline> < ^END>

Examples

```
Dim Var as Double
Var= 0
Ana.WriteString ":CALC1:EPAR:CIRC:A:R1 " & Str(Var), True
Ana.WriteString ":CALC1:EPAR:CIRC:A:R1?", True
Var=Ana.ReadNumber
```

Related Commands

[:CALC:EPAR:CIRC](#)

Equivalent Softkey

Analysis > Equivalent Circuit > R1

COM Command Syntax (Internal Control Only)

SCPI.CALCULATE(Ch).EPARAMETERS.CIRCUIT.{A|B|C|D|E|F|G}.R1

:CALC<Ch>:EPAR:CIRC:E:CO

Type

Command/Query

Syntax

:CALCulate<Ch>:EPARameters:CIRCuit:E:CO <Value>

:CALCulate<Ch>:EPARameters:CIRCuit:E:CO?

Description

This command sets/gets CO value of equivalent circuit parameters (Model E)

Variable

Parameter	Value
Description	CO value
Data Type	Numeric type (Real)
Range	-1E ~ 1E

E4990A Impedance Analyzer Help

Preset Value	0
Unit	F
Resolution	-

Query Response

{ numeric } <newline> < ^END >

Examples

```
Dim Var as Double
Var= 0.001
Ana.WriteString ":CALC1:EPAR:CIRC:E:C0 " & Str(Var), True
Ana.WriteString ":CALC1:EPAR:CIRC:E:C0?", True
Var=Ana.ReadNumber
```

Related Commands

[:CALC:EPAR:CIRC](#)

Equivalent Softkey

Analysis > Equivalent Circuit > C0

COM Command Syntax (Internal Control Only)

SCPI.CALCULATE(Ch).EPARAMETERS.CIRCUIT.E.C0

:CALC<Ch>:EPAR:CIRC:{F|G}:R0

Type

Command/Query

Syntax

:CALCulate<Ch>:EPARameters:CIRCuit: {F|G}:R0 <Value>

:CALCulate<Ch>:EPARameters:CIRCuit: {F|G}:R0?

Description

This command sets/gets R0 value of equivalent circuit parameters (Models F and G)

Variable

Parameter	Value
Description	R0 value
Data Type	Numeric type (Real)
Range	-1E ~ 1E

Preset Value	0
Unit	Ω
Resolution	-

Query Response

{numeric} <newline> < ^END >

Examples

```
Dim Var as Double
Var= 0.01
Ana.WriteString ":CALC1:EPAR:CIRC:F:R0 " & Str(Var), True
Ana.WriteString ":CALC1:EPAR:CIRC:F:R0?", True
Var=Ana.ReadNumber
```

Related Commands

[:CALC:EPAR](#)

Equivalent Softkey

Analysis > Equivalent Circuit > R0

COM Command Syntax (Internal Control Only)

SCPI.CALCULATE(Ch).EPARAMETERS.CIRCUIT.{F|G}.R0

:CALC<Ch>:EPAR:DISP

Type

Command/Query

Syntax

:CALCulate<Ch>:EPARameters:DISPlay[:STATe] {ON|OFF|1|0}

:CALCulate<Ch>:EPARameters:DISPlay[:STATe]?

Description

This command displays the equivalent circuit model on the screen.

Variable

Parameter	Selection Option
Description	Equivalent circuit model display status
Data Type	Boolean type (Boolean)
Range	ON OFF 1 0

Preset Value	OFF
---------------------	-----

Query Response

{1|0} <newline> < ^END>

Examples

```
Dim Var as Integer
Ana.WriteString ":CALC1:EPAR:DISP ON", True
Ana.WriteString ":CALC1:EPAR:DISP?", True
Var=Ana.ReadNumber
```

Related Commands

[:CALC:EPAR:CIRC](#)

[:CALC:EPAR:SIM](#)

Equivalent Softkey

Analysis > Equivalent Circuit > Display

COM Command Syntax (Internal Control Only)

SCPI.CALCULATE(Ch).EPARAMETERS.DISPLAY.STATE

:CALC<Ch>:EPAR:PCO

Type

Query

Syntax

:CALCulate<Ch>:EPARameters:PCO? <value>

Description

This command returns the equivalent circuit parameter CO (parallel capacitance) at the specified frequency. The sweep parameter should be frequency for this analysis.

Variable

Parameter	Value
Description	Frequency
Data Type	Numeric type (Real)
Range	20 to 120M
Unit	Hz
Resolution	- -

Query Response

```
{numeric (C0 [F])} <newline>< ^END>
```

Examples

```
Dim Var as Double
Ana.WriteString ":CALC1:EPAR:PC0? 1E6",True
Var=Ana.ReadNumber
```

Related Commands

[:SENS:SWE:TYPE](#)

Equivalent Softkey

No equivalent key is available on the front panel.

COM Command Syntax (Internal Control Only)

```
SCPI.CALCULATE(Ch).EPARAMETERS.PC0
```

:CALC<Ch>:EPAR:S4

Type

Query

Syntax

```
:CALCulate<Ch>:EPARameters:S4?
```

Description

This command returns the result of the 4-device equivalent circuit parameters of a crystal oscillator. The sweep parameter should be frequency, and the measurement parameter should be Z-θ for this analysis.

C0, C1, L1 and R1 are calculated using the following equations.

$$C0 = C1 \times fr^2 / (fa^2 - fr^2)$$

$$C1 = 1 / (Q \times R1 \times 2 \times \pi \times fs)$$

$$L1 = Q \times R1 / (2 \times \pi \times fs)$$

$$R1 = 1 / Gmax$$

$$Q = |fs / (f2 - f1)|$$

If there are no fa and fr points on the admittance chart, C0 is calculated using the following equation.

$$C0 = Bfs / (2 \times \pi \times fs)$$

Query Response

```
{numeric1 (C0)}, {numeric2 (C1)}, {numeric3 (L1)}, {numeric4 (R1)},
{numeric5 (fs)}, {numeric6 (fa)}, {numeric7 (fr)}, {numeric8 (f1)},
{numeric9 (f2)} < ^END>
```

E4990A Impedance Analyzer Help

C0 (parallel capacitance)

C1 (motional capacitance)

L1 (motional inductance)

R1 (motional resistance)

fs (motional (series) resonant frequency)

fa (anti-resonant frequency)

fr (resonant frequency)

f1 (frequency at which the conductance is half the maximum value)

f2 (frequency at which the conductance is half the maximum value. Note that $f1 < f2$)

Examples

```
Dim Var as Variant
Ana.WriteString ":CALC1:EPAR:S4?", True
Var=Ana.ReadList(ASCIIType_R8, ",")
```

Related Commands

[:SENS:SWE:TYPE](#)

[:CALC:PAR:DEF](#)

Equivalent Softkey

No equivalent key is available on the front panel.

COM Command Syntax (Internal Control Only)

```
SCPI.CALCULATE(Ch).EPARAMETERS.S4
```

:CALC<Ch>:EPAR:SIM

Type

Command

Syntax

:CALCulate<Ch>:EPARameters:SIMulate[:IMMEDIATE]

Description

This command writes the simulation results into the memory trace, then set "Data & Mem" for the display setting. All traces related with impedance measurement are updated, even if [:CALC:EPAR:SIM:AUTO](#) is set at OFF.

Examples

```
Ana.WriteString ":CALC1:EPAR:SIM", True
```

Related Commands

[:CALC:EPAR](#)

[:CALC:EPAR:DISP](#)

[:CALC:EPAR:SIM:AUTO](#)

Equivalent Softkey

There is no equivalent key is available on the front panel. However, the similar key is:

Analysis > Equivalent Circuit > Simulate

- When this softkey is turned ON, its equivalent to the set of following two commands:
 - [:CALC:EPAR:SIM:AUTO](#) ON
 - [:CALC:EPAR:SIM](#)
- When this softkey is turned OFF, its equivalent to:
 - [:CALC:EPAR:SIM:AUTO](#) OFF

COM Command Syntax (Internal Control Only)

SCPI.CALCULATE(Ch).EPARAMETERS.SIMULATE.IMMEDIATE

:CALC<Ch>:EPAR:SIM:AUTO

Type

Command/Query

Syntax

:CALCulate<Ch>:EPARameters:SIMulate:AUtO {ON|OFF|1|0}

:CALCulate<Ch>:EPARameters:SIMulate:AUtO?

Description

This command executes the equivalent circuit analysis simulation function automatically when parameters are changed. When this is set at ON, if one of the parameter is changed or set, the simulation calculation is done automatically. If its set at OFF, the simulation calculation is not executed but the simulated Memory Trace is still shown.

Variable

Parameter	Selection Option
Description	Simulate Auto Status
Data Type	Boolean type (Boolean)
Range	ON OFF 1 0
Preset Value	OFF

Query Response

{1|0}<newline><^END>

Examples

E4990A Impedance Analyzer Help

```
Dim Var as Integer
Ana.WriteString ":CALC1:EPAR:SIM:AUTO ON", True
Ana.WriteString ":CALC1:EPAR:SIM:AUTO?", True
Var=Ana.ReadNumber
```

Related Commands

[:CALC:EPAR:SIM](#)

Equivalent Softkey

See [:CALC:EPAR:SIM](#)

COM Command Syntax (Internal Control Only)

```
SCPI.CALCULATE(Ch).EPARAMETERS.SIMULATE.AUTO
```

:CALC<Ch>:EQU:STAT

Type

Command/Query

Syntax

```
:CALCulate<Ch>[:SElected]:EQUation:STATe {ON|OFF|1|0}
```

```
:CALCulate<Ch>[:SElected]:EQUation:STATe?
```

Description

This command sets/gets the equation state.

Variable

Parameter	Selection Option
Description	Equation state
Data Type	Boolean type (Boolean)
Range	ON OFF 1 0
Preset Value	OFF

Query Response

```
{1|0}<newline><^END>
```

Examples

```
Dim Var as Integer
Ana.WriteString ":CALC1:EQU:STAT ON", True
Ana.WriteString ":CALC1:EQU:STAT?", True
Var=Ana.ReadNumber
```

Related Commands

[:CALC:EQU:TEXT](#)

[:CALC:EQU:VAL](#)

Equivalent Softkey

Display > Equation

COM Command Syntax (Internal Control Only)

```
SCPI.CALCULATE(Ch).SELECTED.EQUATION.STATE
```

```
:CALC<Ch>:EQU:TEXT
```

Type

Command/Query

Syntax

```
:CALCulate<Ch>[:SELEcted]:EQUation:TEXT <String>
```

```
:CALCulate<Ch>[:SELEcted]:EQUation:TEXT?
```

Description

This command sets/gets the equation in the Equation Editor. For valid parameters that can be used in this equation, refer to the [Equation Editor](#).

Variable

Parameter	String
Description	Equation string.
Data Type	Character string type (String)
Range	254 chars
Preset Value	""

Query Response

```
{String} <newline> < ^END>
```

Examples

```
Dim Var as String
Var = "Z=ACV/ACI"
Ana.WriteString ":CALC1:EQU:TEXT " & Var, True
Ana.WriteString ":CALC1:EQU:TEXT?", True
Var=Ana.ReadString
```

Related Commands

[:CALC: EQU: STAT](#)

Equivalent Softkey

[Equation in the Equation Editor](#)

COM Command Syntax (Internal Control Only)

```
SCPI.CALCULATE(Ch).SELECTED.EQUATION.TEXT
```

E4990A Impedance Analyzer Help

:CALC<Ch>:EQU:VAL

Type

Query

Syntax

:CALCulate<Ch>[:SElected]:EQUation:VALid?

Description

This command always returns 1.

Query Response

1<newline><^END>

Examples

```
Dim Var as Integer
Ana.WriteString ":CALC1:EQU:VAL?", True
Var=Ana.ReadNumber
```

Related Commands

[:CALC:EQU:STAT](#)

[:CALC:EQU:TEXT](#)

Equivalent Softkey

No equivalent key is available on the front panel.

COM Command Syntax (Internal Control Only)

SCPI.CALCULATE(Ch).SELECTED.EQUATION.VALID

:CALC<Ch>:FORM:EPH

Type

Command/Query

Syntax

:CALCulate<Ch>[:SElected]:FORMat:EPHase {ON|OFF|1|0}

:CALCulate<Ch>[:SElected]:FORMat:EPHase?

Description

This command turns on/off the expand phase.

Variable

Parameter	Selection Option
Description	Expand phase
Data Type	Boolean type (Boolean)
Range	ON OFF 1 0

Preset Value	OFF
---------------------	-----

Query Response

```
{1|0} <newline> < ^END>
```

Examples

```
Dim Var as Integer
Ana.WriteString ":CALC1:FORM:EPH ON", True
Ana.WriteString ":CALC1:FORM:EPH?", True
Var=Ana.ReadNumber
```

Related Commands

[:CALC:PAR:DEF](#)

Equivalent Softkey

Format > **Expand Phase**

COM Command Syntax (Internal Control Only)

```
SCPI.CALCULATE(Ch).SELECTED.FORMAT.EPHASE
```

```
:CALC<Ch>:FORM:TWOD
```

Type

Command/Query

Syntax

```
:CALCulate<Ch>[:SELEcted]:FORMat:TWODimension {COMPLex|POLar}
```

```
:CALCulate<Ch>[:SELEcted]:FORMat:TWODimension?
```

Description

This command sets/gets a format type of 2-Dimensional graph.

Variable

Parameter	Selection Option
Description	Format type
Data Type	Character string type (String)
Range	COMPLex POLar
Preset Value	COMPLex

Query Response

```
{COMP|POL} <newline> < ^END>
```

Examples

E4990A Impedance Analyzer Help

```
Dim Var as String
Var= "COMP"
Ana.WriteString ":CALC1:FORM:TWOD " & Var, True
Ana.WriteString ":CALC1:FORM:TWOD?", True
Var=Ana.ReadString
```

Related Commands

[:CALC:PAR:DEF](#)

Equivalent Softkey

Format > **Complex Format**

COM Command Syntax (Internal Control Only)

```
SCPI.CALCULATE(Ch).SELECTED.FORMAT.TWODIMENSION
```

:CALC<Ch>:FUNC:DATA

Type

Query

Syntax

```
:CALCulate<Ch>[:SElected]:FUNCtion:DATA?
```

Description

This command reads the analysis result of the [:CALC:FUNC:EXEC](#).

Query Response

When [:CALC:FUNC:TYPE](#) is either PTP, STDEV, MEAN, MAX, MIN, PEAK, APE, ATAR, or SDEV.

```
{numeric 1}, ..., {numeric Nx2} <newline> < ^END >
```

N (number of data pairs) can be read out with the [:CALC:FUNC:POIN](#).

{numeric n×2-1}: Response value or analysis result of the searched n-th result. {numeric nx2}: Stimulus value of the searched n-th result.

When [:CALC:FUNC:TYPE](#) is either RPP, RPLH, RPLL, or RPLR.

```
{numeric}
```

When [:CALC:FUNC:TYPE](#) is RESO

```
{numeric (Zr: Resonant impedance)}, {numeric (fr: Resonant frequency)},
{numeric (Za: Antiresonant impedance)}, {numeric (fa: Antiresonant
frequency)}
```

When [:CALC:FUNC:TYPE](#) is RESR

```
{numeric (Zr: Resonant impedance)}, {numeric (fr: Resonant frequency)},
{numeric (Za: Antiresonant impedance)}, {numeric (fa: Antiresonant
frequency)}, {numeric (Ripple 1)}, {numeric (Ripple 2)}, {numeric
(Ripple 3)}
```

- Ripple 1: the maximum value of the left-side ripple (the sweep parameter difference between the peak and the left adjacent

negative peak) within the range to the left of the resonant point within the waveform analysis range.

- Ripple 2: the maximum value of the right ripple (the sweep parameter difference between the peak and the right adjacent negative peak) within the range between the resonant point and the anti-resonant point within the waveform analysis range.
- Ripple 3: the maximum value of the left-side ripple within the range to the right of the resonant point within the waveform analysis range.

NOTE

This searches for phase 0° points within the analysis range from the left edge, and defines the 1st detected point as the resonant point and the 2nd detected point as the anti-resonant point. Even if 3 or more phase 0° points are detected, only the first 2 points are used. If only 1 phase 0° point is detected, 0 is read out for parameters other than Z_r , f_r , and $Rpl1$. If no phase 0° point is detected, 0 is read out for all the parameters.

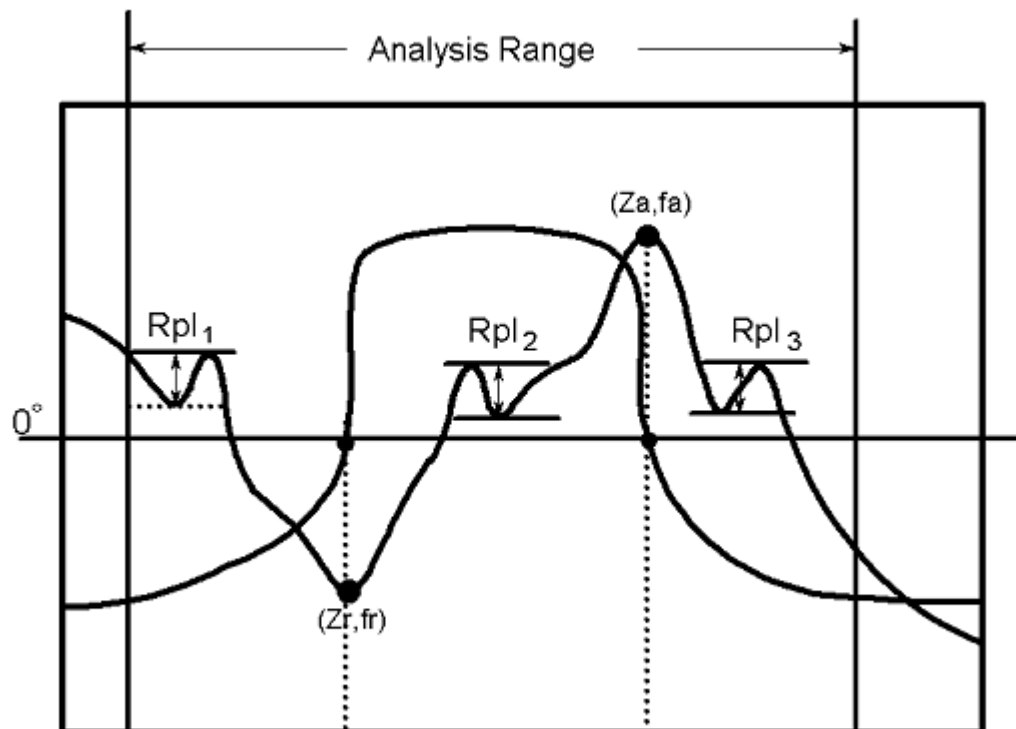
**e4990a102**

{numeric (Z_r : Resonant impedance)}, {numeric (f_r : Resonant frequency)},
 {numeric (Z_a : Antiresonant impedance)}, {numeric (f_a : Antiresonant

frequency)}, {numeric (Ripple 1)}, {numeric (Ripple 2)}, {numeric (Ripple 3)}

- Ripple 1: the maximum value of the left-side ripple (the sweep parameter difference between the peak and the left adjacent negative peak) within the range to the left of the resonant point within the waveform analysis range.
- Ripple 2: the maximum value of the right-side ripple (the sweep parameter difference between the peak and the right adjacent negative peak) within the range between the resonant point and the anti-resonant point within the waveform analysis range.
- Ripple 3: the maximum value of the left-side ripple within the range to the right of the resonant point within the waveform analysis range.

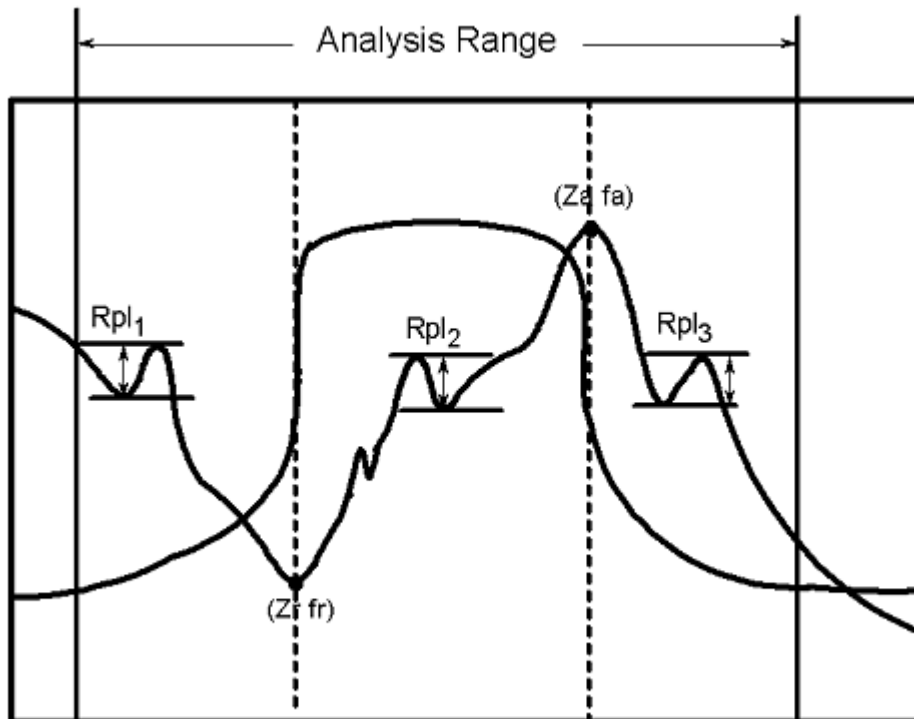

e4990a103

Examples

```
Dim Var as Variant
Ana.WriteString ":CALC1:FUNC:DATA?", True
Var=Ana.ReadList(ASCIIType_R8, ",")
```

Related Commands

[:CALC:FUNC:TYPE](#)

[:CALC:FUNC:EXEC](#)

[:CALC:FUNC:POIN](#)

Equivalent Softkey

No equivalent key is available on the front panel.

COM Command Syntax (Internal Control Only)

SCPI.CALCULATE(Ch).SELECTED.FUNCTION.DATA

:CALC:FUNC:DOM

Type

Command/Query

Syntax

:CALCulate[:SELEcted]:FUNction:DOMain[:STATe] {ON|OFF|1|0}

:CALCulate[:SELEcted]:FUNction:DOMain[:STATe]?

Description

This command sets/gets an arbitrary range for analysis.

When the trace coupling is OFF, the active trace is the target to be set.

Variable

Parameter	Selection Option
Description	Analysis range On/Off status
Data Type	Boolean type (Boolean)
Range	ON OFF 1 0
Preset Value	OFF

Query Response

{1|0} <newline> < ^END >

Examples

```
Dim Var as Integer
Ana.WriteString ":CALC:FUNC:DOM ON", True
Ana.WriteString ":CALC:FUNC:DOM?", True
Var=Ana.ReadNumber
```

Related Commands

[:CALC:FUNC:DOM:COUP](#)

[:CALC:FUNC:DOM:STAR](#)

[:CALC:FUNC:DOM:STOP](#)

Equivalent Softkey

No equivalent key is available on the front panel.

COM Command Syntax (Internal Control Only)

SCPI.CALCULATE.SELECTED.FUNCTION.DOMAIN.STATE

:CALC:FUNC:DOM:COUP

Type

Command/Query

Syntax

:CALCulate[:SElected]:FUNction:DOMain:COUPlE {ON|OFF|1|0}

:CALCulate[:SElected]:FUNction:DOMain:COUPlE?

Description

This command sets/gets whether to set the coupling of the analysis range for all traces.

Variable

Parameter	Selection Option
Description	Couple state.
Data Type	Boolean type (Boolean)
Range	ON OFF 1 0
Preset Value	ON

Query Response

{1|0} <newline> < ^END >

Examples

Dim Var as Integer
Ana.WriteString ":CALC:FUNC:DOM:COUP ON", True
Ana.WriteString ":CALC:FUNC:DOM:COUP?", True
Var=Ana.ReadNumber

Related Commands

[:CALC:FUNC:DOM](#)

Equivalent Softkey

No equivalent key is available on the front panel.

COM Command Syntax (Internal Control Only)

SCPI.CALCULATE.SELECTED.FUNCTION.DOMAIN.COUPLE

:CALC:FUNC:DOM:STAR

Type

Command/Query

Syntax

:CALCulate[:SElected]:FUNCtion:DOMain:START <Value>

:CALCulate[:SElected]:FUNCtion:DOMain:START?

Description

This command sets/gets the start value of the analysis range.

When the trace coupling is OFF, the active trace or selected trace is the target to be set.

Variable

Parameter	Value
Description	Start value
Data Type	Numeric type (Real)
Range	-500G ~ 500G
Preset Value	0
Unit	-
Resolution	-

Query Response

{ numeric } <newline> < ^END >

Examples

```
Dim Var as Double
Var= 1000000
Ana.WriteString ":CALC1:FUNC:DOM:STAR " & Str(Var), True
Ana.WriteString ":CALC1:FUNC:DOM:STAR?", True
Var=Ana.ReadNumber
```

Related Commands

[:CALC:FUNC:DOM:STOP](#)

Equivalent Softkey

No equivalent key is available on the front panel.

COM Command Syntax (Internal Control Only)

SCPI.CALCULATE.SELECTED.FUNCTION.DOMAIN.START

:CALC:FUNC:DOM:STOP

Type

Command/Query

E4990A Impedance Analyzer Help

Syntax

:CALCulate[:SElected]:FUNCtion:DOMain:STOP <Value>

:CALCulate[:SElected]:FUNCtion:DOMain:STOP?

Description

This command sets/gets the stop value of the analysis range. When the trace coupling is OFF, the active trace or selected trace is the target to be set.

Variable

Parameter	Value
Description	Stop value
Data Type	Numeric type (Real)
Range	-500G ~ 500G
Preset Value	0
Unit	-
Resolution	-

Query Response

{ numeric } <newline> < ^END >

Examples

```
Dim Var as Double
Var= -500000000000
Ana.WriteString ":CALC:FUNC:DOM:STOP " & Str(Var), True
Ana.WriteString ":CALC:FUNC:DOM:STOP?", True
Var=Ana.ReadNumber
```

Related Commands

[:CALC:FUNC:DOM:STAR](#)

Equivalent Softkey

No equivalent key is available on the front panel.

COM Command Syntax (Internal Control Only)

SCPI.CALCULATE(Ch).SELECTED.FUNCTION.DOMAIN.STOP

:CALC<Ch>:FUNC:EXEC

Type

Command

Syntax

```
:CALCulate<Ch>[:SElected]:FUNCtion:EXECute
```

Description

This command executes the analysis function.

Examples

```
Ana.WriteString ":CALC1:FUNC:EXEC", True
```

Related Commands

[:CALC:PAR:DEF](#)

Equivalent Softkey

No equivalent key is available on the front panel.

COM Command Syntax (Internal Control Only)

```
SCPI.CALCULATE(Ch).SELECTED.FUNCTION.EXECUTE
```

```
:CALC<Ch>:FUNC:PEXC
```

Type

Command/Query

Syntax

```
:CALCulate<Ch>[:SElected]:FUNCtion:PEXCursion <Value>
```

```
:CALCulate<Ch>[:SElected]:FUNCtion:PEXCursion?
```

Description

This command sets/gets the peak excursion value.

Variable

Parameter	Value
Description	Peak excursion value
Data Type	Numeric type (Real)
Range	0 ~ 500M
Preset Value	3
Resolution	-

Query Response

```
{numeric} <newline> < ^END >
```

Examples

E4990A Impedance Analyzer Help

```
Dim Var as Double
Var= 10
Ana.WriteString ":CALC1:FUNC:PEXC " & Str(Var), True
Ana.WriteString ":CALC1:FUNC:PEXC?", True
Var=Ana.ReadNumber
```

Related Commands

[:CALC:FUNC:TYPE](#)

[:CALC:FUNC:PPOL](#)

Equivalent Softkey

No equivalent key is available on the front panel.

COM Command Syntax (Internal Control Only)

```
SCPI.CALCULATE(Ch).SELECTED.FUNCTION.PEXCURSION
```

:CALC<Ch>:FUNC:POIN

Type

Query

Syntax

```
:CALCulate<Ch>[:SElected]:FUNction:POINts?
```

Description

This command gets number of data pair in [:CALC:FUNC:DATA](#).

Query Response

```
{ numeric } <newline> < ^END >
```

Examples

```
Dim Var as Long
Ana.WriteString ":CALC1:FUNC:POIN?", True
Var=Ana.ReadNumber
```

Related Commands

[:CALC:FUNC:DATA](#)

Equivalent Softkey

No equivalent key is available on the front panel.

COM Command Syntax (Internal Control Only)

```
SCPI.CALCULATE(Ch).SELECTED.FUNCTION.POINTS
```

:CALC<Ch>:FUNC:PPOL

Type

Command/Query

Syntax

```
:CALCulate<Ch>[:SElected]:FUNction:PPOLarity
{ POSitive|NEGative|BOTH }
```

```
:CALCulate<Ch>[:SElected]:FUNction:PPOLarity?
```

Description

This command sets/gets the polarity when performing the peak search with [:CALC:FUNC:EXEC](#).

Variable

Parameter	Selection Option
Description	Peak polarity type
Data Type	Character string type (String)
Range	"POSitive": Positive peak. "NEGative": Negative peak. "BOTH": Both the positive peak and the negative peak
Preset Value	POSitive

Query Response

```
{ POS|NEG|BOTH} <newline> < ^END>
```

Examples

```
Dim Var as String
Var= "POS"
Ana.WriteString ":CALC1:FUNC:PPOL " & Var, True
Ana.WriteString ":CALC1:FUNC:PPOL?", True
Var=Ana.ReadString
```

Related Commands

[:CALC:FUNC:EXEC](#)

[:CALC:FUNC:TYPE](#)

Equivalent Softkey

No equivalent key is available on the front panel.

COM Command Syntax (Internal Control Only)

```
SCPI.CALCULATE(Ch).SELECTED.FUNCTION.PPOLARITY
```

:CALC<Ch>:FUNC:TARG

Type

Command/Query

Syntax

```
:CALCulate<Ch>[:SElected]:FUNction:TARGet <Value>
```

```
:CALCulate<Ch>[:SElected]:FUNction:TARGet?
```

Description

E4990A Impedance Analyzer Help

This command sets/gets the target value when performing the target search with the [:CALC:FUNC:EXEC](#).

Variable

Parameter	Value
Description	Target value
Data Type	Numeric type (Real)
Range	-500M ~ 500M
Preset Value	0
Resolution	-

Query Response

```
{ numeric } <newline> < ^END >
```

Examples

```
Dim Var as Double  
Var= 100  
Ana.WriteString ":CALC1:FUNC:TARG " & Str(Var), True  
Ana.WriteString ":CALC1:FUNC:TARG?", True  
Var=Ana.ReadNumber
```

Related Commands

[:CALC:FUNC:EXEC](#)

[:CALC:FUNC:TYPE](#)

Equivalent Softkey

No equivalent key is available on the front panel.

COM Command Syntax (Internal Control Only)

```
SCPI.CALCULATE(Ch).SELECTED.FUNCTION.TARGET
```

```
:CALC<Ch>:FUNC:TTR
```

Type

Command/Query

Syntax

```
:CALCulate<Ch>[:SElected]:FUNction:TTRansition  
{ POSitive|NEGative|BOTH}
```

```
:CALCulate<Ch>[:SElected]:FUNction:TTRansition?
```

Description

This command sets/gets the transition type when performing the target search with the [:CALC:FUNC:EXEC](#).

Variable

Parameter	Selection Option
Description	Transition type
Data Type	Character string type (String)
Range	"POSitive": Positive transition. "NEGative": Negative transition. "BOTH": Both the positive transition and the negative transition.
Preset Value	BOTH

Query Response

```
{ POS|NEG|BOTH} <newline> < ^END>
```

Examples

```
Dim Var as String
Var= "POS"
Ana.WriteString ":CALC1:FUNC:TTR " & Var, True
Ana.WriteString ":CALC1:FUNC:TTR?", True
Var=Ana.ReadString
```

Related Commands

[:CALC:FUNC:EXEC](#)

[:CALC:FUNC:TYPE](#)

Equivalent Softkey

No equivalent key is available on the front panel.

COM Command Syntax (Internal Control Only)

```
SCPI.CALCULATE(Ch).SELECTED.FUNCTION.TTRANSITION
```

```
:CALC<Ch>:FUNC:TYPE
```

Type

Command/Query

Syntax

```
:CALCulate<Ch>[:SElected]:FUNCtion:TYPE
{PTPeak|STDEV|MEAN|MAXimum|MINimum|PEAK|APEak|ATARget|SDEViation|RPP|RPLHei|RPLLhei|RPLRhei|RESO|RESR|CERR}
```

:CALCulate<Ch>[:SELEcted]:FUNction:TYPE?

Description

This command sets/gets the type of analysis.

Variable

Parameter	Selection Option
Description	Analysis type
Data Type	Character string type (String)
Range	<p>"PTPeak": Specifies the analysis of the difference between the maximum value and the minimum value (Peak to Peak).</p> <p>"STDEV": Specifies the analysis of the standard deviation.</p> <p>"MEAN": Specifies the analysis of the mean value.</p> <p>"MAXimum": Specifies the search for the maximum value.</p> <p>"MINimum": Specifies the search for the minimum value.</p> <p>"PEAK": Specifies the search for the peak.</p> <p>"APEak": Specifies the search for all peaks.</p> <p>"ATARget": Specifies the search for all targets.</p> <p>"SDEViation": Specifies the search for all deviations.</p> <p>"RPP": Specifies the search for the difference value between the maximum peak measurement parameter value and the minimum negative peak measurement parameter value.</p> <p>"RPLHei": Specifies the search for the maximum value after calculating the ripple (measurement parameter value difference between the peak and its both side adjacent negative peak).</p> <p>"RPLLhei": Specifies the search for the maximum value after calculating the left-side ripple (measurement parameter value difference between the peak and its left adjacent negative peak).</p> <p>"RPLRhei": Specifies the search for the maximum value after calculating the right-side ripple (measurement parameter value difference between the peak and its</p>

	<p>right adjacent negative peak).</p> <p>"RESO": Specifies the resonant analysis.</p> <p>"RESR": Specifies the resonant analysis with ripples.</p> <p>"CERR": Specifies the ceramic oscillator analysis.</p>
Preset Value	PTPeak

Query Response

```
{PTP|STDEV|MEAN|MAX|MIN|PEAK|APE|ATAR|SDEV|RPP|RPLH|RPLL|RPLR
|RESO|RESR|CERR} <newline> < ^END>
```

Examples

```
Dim Var as String
Var= "PTP"
Ana.WriteString ":CALC1:FUNC:TYPE " & Var, True
Ana.WriteString ":CALC1:FUNC:TYPE?", True
Var=Ana.ReadString
```

Related Commands

[:CALC:FUNC:DATA](#)

[:CALC:FUNC:EXEC](#)

Equivalent Softkey

No equivalent key is available on the front panel.

COM Command Syntax (Internal Control Only)

```
SCPI.CALCULATE(Ch).SELECTED.FUNCTION.TYPE
```

```
:CALC<Ch>:LIM
```

Type

Command/Query

Syntax

```
:CALCulate<Ch>[:SElected]:LIMit[:STATe] {ON|OFF|1|0}
```

```
:CALCulate<Ch>[:SElected]:LIMit[:STATe]?
```

Description

This command turns the limit test On/Off.

Variable

Parameter	Selection Option
Description	Limit test On/Off status

E4990A Impedance Analyzer Help

Data Type	Boolean type (Boolean)
Range	ON OFF 1 0
Preset Value	OFF

Query Response

{1|0} <newline> <^END>

Examples

```
Dim Var as Integer
Ana.WriteString ":CALC1:LIM ON", True
Ana.WriteString ":CALC1:LIM?", True
Var=Ana.ReadNumber
```

Related Commands

[:CALC:LIM:DATA](#)

Equivalent Softkey

Analysis > Limit Test > Limit Test

COM Command Syntax (Internal Control Only)

SCPI.CALCULATE(Ch).SELECTED.LIMIT.STATE

:CALC<Ch>:LIM:DATA

Type

Command/Query

Syntax

:CALCulate<Ch>[:SElected]:LIMit:DATA <Value>

:CALCulate<Ch>[:SElected]:LIMit:DATA?

Description

This command sets/gets the limit table for the limit test.

Variable

Parameter	Value
Description	<p>Indicates the array data (for limit line) of 1 + Num (number of limit lines)*5. Where n is an integer between 1 and Num.</p> <ul style="list-style-type: none"> Data(0) : The number of limit lines you want to set. Specify an integer ranging 0 to 100. When the number of limit lines is set to 0 (clears the limit table), the variable Data is only required with

	<p>Data(0).</p> <ul style="list-style-type: none"> ▪ Data(n*5-4) : The type of the n-th line. Specify an integer 0 to 2 as follows. 0: OFF 1: Upper limit line 2: Lower limit line ▪ Data(n*5-3) : The value on the horizontal axis (frequency/osc level/DC bias) of the start point of the n-th line. ▪ Data(n*5-2) : The value on the horizontal axis (frequency/power/DC bias) of the end point of the n-th line. ▪ Data(n*5-1) : The value on the vertical axis of the start point of the n-th line. ▪ Data(n*5) : The value on the vertical axis of the end point of the n-th line. <p>The index of the array starts from 0.</p>
Data Type	Variant type Array (Range)
Note	<p>If there is no array data, an error occurs at execution and the object is ignored.</p> <p>For Data(n×5-4) in the array data, if you specify an integer other than 0, 1 or 2, an error occurs at execution.</p> <p>For Data(n×5-3), Data(n×5-2), Data(n×5-1), and Data(n×5) in the array data, if the specified value is out of the allowable setup range, the minimum value (if the lower limit of the range is not reached) or the maximum value (if the upper limit of the range is exceeded) is set.</p>

Query Response

```
{ numeric 1 } , ... { numeric 1 + (n*5) } <newline> < ^END >
```

Examples

See limit line.

Related Commands

[:CALC:LIM](#)

Equivalent Softkey

Analysis > Limit Test > Edit Limit Line

E4990A Impedance Analyzer Help

COM Command Syntax (Internal Control Only)

SCPI.CALCULATE(Ch).SELECTED.LIMIT.DATA

:CALC<Ch>:LIM:DISP

Type

Command/Query

Syntax

:CALCulate<Ch>[:SElected]:LIMit:DISPlay[:STATe] {ON|OFF|1|0}

:CALCulate<Ch>[:SElected]:LIMit:DISPlay[:STATe]?

Description

This command shows/hides the limit line.

Variable

Parameter	Selection Option
Description	limit line On/Off status
Data Type	Boolean type (Boolean)
Range	ON OFF 1 0
Preset Value	OFF

Query Response

{1|0}<newline><^END>

Examples

```
Dim Var as Integer
Ana.WriteString ":CALC1:LIM:DISP ON", True
Ana.WriteString ":CALC1:LIM:DISP?", True
Var=Ana.ReadNumber
```

Related Commands

[:CALC:LIM](#)

Equivalent Softkey

Analysis > Limit Test > Limit Line

COM Command Syntax (Internal Control Only)

SCPI.CALCULATE(Ch).SELECTED.LIMIT.DISPLAY.STATE

:CALC<Ch>:LIM:DISP:CLIP

Type

Command/Query

Syntax

```
:CALCulate<Ch>[:SElected]:LIMit:DISPlay:CLIP {ON|OFF|1|0}
```

```
:CALCulate<Ch>[:SElected]:LIMit:DISPlay:CLIP?
```

Description

This command clips/unclips limit lines.

Variable

Parameter	Selection Option
Description	limit lines clip On/Off status
Data Type	Boolean type (Boolean)
Range	ON OFF 1 0
Preset Value	ON

Query Response

```
{1|0}<newline><^END>
```

Examples

```
Dim Var as Integer
Ana.WriteString ":CALC1:LIM:DISP:CLIP ON", True
Ana.WriteString ":CALC1:LIM:DISP:CLIP?", True
Var=Ana.ReadNumber
```

Related Commands

[:CALC:LIM](#)

Equivalent Softkey

Analysis > Limit Test > Clip Lines

COM Command Syntax (Internal Control Only)

```
SCPI.CALCULATE(Ch).SELECTED.LIMIT.DISPLAY.CLIP
```

```
:CALC<Ch>:LIM:FAIL
```

Type

Query

Syntax

```
:CALCulate<Ch>[:SElected]:LIMit:FAIL?
```

Description

This command returns the pass/fail result.

Query Response

```
{1|0}<newline><^END>
```

E4990A Impedance Analyzer Help

1: Fail, 0: Pass

Examples

```
Dim Var as Integer
Ana.WriteString ":CALC1:LIM:FAIL?", True
Var=Ana.ReadNumber
```

Related Commands

[:CALC:LIM](#)

Equivalent Softkey

No equivalent key is available on the front panel.

COM Command Syntax (Internal Control Only)

```
SCPI.CALCULATE(Ch).SELECTED.LIMIT.FAIL
```

```
:CALC<Ch>:LIM:OFFS:AMPL
```

Type

Command/Query

Syntax

```
:CALCulate<Ch>[:SElected]:LIMit:OFFSet:AMPLitude <Value>
```

```
:CALCulate<Ch>[:SElected]:LIMit:OFFSet:AMPLitude?
```

Description

This command sets/gets the limit line amplitude offset.

Variable

Parameter	Value
Description	Amplitude offset value
Data Type	Numeric type (Real)
Range	-500M ~ 500M
Preset Value	0
Unit	Depending on Measurement Format
Resolution	-

Query Response

```
{numeric} <newline> < ^END>
```

Examples

```
Dim Var as Double
Var= 10
Ana.WriteString ":CALC1:LIM:OFFS:AMPL " & Str(Var), True
Ana.WriteString ":CALC1:LIM:OFFS:AMPL?", True
Var=Ana.ReadNumber
```

Related Commands

[:CALC:LIM](#)

[:CALC:LIM:OFFS:STIM](#)

Equivalent Softkey

Analysis > Limit Test > Limit Line Offsets > Amplitude Offset

COM Command Syntax (Internal Control Only)

```
SCPI.CALCULATE(Ch).SELECTED.LIMIT.OFFSET.AMPLITUDE
```

```
:CALC<Ch>:LIM:OFFS:MARK
```

Type

Command

Syntax

```
:CALCulate<Ch>[:SElected]:LIMit:OFFSet:MARKer
```

Description

This command sets the current active marker value as the limit line amplitude offset value.

Examples

```
Ana.WriteString ":CALC1:LIM:OFFS:MARK", True
```

Related Commands

[:CALC:LIM:OFFS:STIM](#)

Equivalent Softkey

Analysis > Limit Test > Limit Line Offsets > Marker -> Amplitude Offset

COM Command Syntax (Internal Control Only)

```
SCPI.CALCULATE(Ch).SELECTED.LIMIT.OFFSET.MARKER
```

```
:CALC<Ch>:LIM:OFFS:STIM
```

Type

Command/Query

Syntax

```
:CALCulate<Ch>[:SElected]:LIMit:OFFSet:STIMulus <Value>
```

```
:CALCulate<Ch>[:SElected]:LIMit:OFFSet:STIMulus?
```

Description

This command sets/gets the limit line stimulus offset.

Variable

Parameter	Value

E4990A Impedance Analyzer Help

Description	Limit line stimulus offset
Data Type	Numeric type (Real)
Range	-1T ~ 1T
Preset Value	0
Unit	Hz V A
Resolution	-

Query Response

{ numeric } <newline> < ^END>

Examples

```
Dim Var as Double
Var= 10
Ana.WriteString ":CALC1:LIM:OFFS:STIM " & Str(Var), True
Ana.WriteString ":CALC1:LIM:OFFS:STIM?", True
Var=Ana.ReadNumber
```

Related Commands

[:CALC:LIM](#)

[:CALC:LIM:OFFS:AMPL](#)

Equivalent Softkey

Analysis > Limit Test > Limit Line Offsets > Stimulus Offset

COM Command Syntax (Internal Control Only)

SCPI.CALCULATE(Ch).SELECTED.LIMIT.OFFSET.STIMULUS

:CALC<Ch>:LIM:REP

Type

Query

Syntax

:CALCulate<Ch>[:SElected]:LIMit:REPort[:DATA]?

Description

This command returns the stimulus values at all the measurement points that failed the limit test. if no numbers, return 9.91E37.

Query Response

{ numeric 1 } ... { numeric NOP } <newline> < ^END>

NOP is the value returned with [:CALC:LIM:REP:POIN](#).

Examples

```
Dim Var as Variant
Ana.WriteString ":CALC1:LIM:REP?", True
Var=Ana.ReadList(ASCIIType_R8, ",")
```

Related Commands

[:CALC:LIM:REP:POIN](#)

Equivalent Softkey

No equivalent key is available on the front panel.

COM Command Syntax (Internal Control Only)

SCPI.CALCULATE(Ch).SELECTED.LIMIT.REPORT.DATA

:CALC<Ch>:LIM:REP:ALL

Type

Query

Syntax

:CALCulate<Ch>[:SElected]:LIMit:REPort:ALL?

Description

This command returns the limit test result of all measurement points.

Query Response

{numeric 1}, ..., {numeric (NOP×3)} <newline> <^END>

{numeric (n×3)-2}: Limit test result

- 0: FAIL
- 1: PASS
- -1: Limit test was off

{numeric (n×3)-1}: Upper border value of the limit (0 is returned if no limit line is set.)

{numeric (n×3)}: Lower border value of the limit (0 is returned if no limit line is set.)

Preset value is -1, 0, 0.

Examples

```
Dim Var as Variant
Ana.WriteString ":CALC1:LIM:REP:ALL?", True
Var=Ana.ReadList(ASCIIType_R8, ",")
```

Related Commands

[:CALC:LIM:REP](#)

E4990A Impedance Analyzer Help

Equivalent Softkey

No equivalent key is available on the front panel.

COM Command Syntax (Internal Control Only)

SCPI.CALCULATE(Ch).SELECTED.LIMIT.REPORT.ALL

:CALC<Ch>:LIM:REP:MARK<Mk>

Type

Query

Syntax

:CALCulate<Ch>[:SELEcted]:LIMit:REPort:MARKer<Mk>[:ALL]?

Description

This command returns the limit test result of measurement point of the active marker position. (Mk: marker 1 to 9 and reference marker 10.)

If the marker function is off, executing this command causes an error and invalid values are read out.

If marker discrete is set at Off and the marker is located between two points, the value at the closest point is returned.

Variable

Query Response

{numeric 1},{numeric 2},{numeric 3},{numeric 4}<newline><^END>

{numeric 1}: Sweep parameter value at Marker position

{numeric 2}: Limit test result

- 0: FAIL
- 1: PASS
- -1: Limit test was off

{numeric 3}: Upper border value of the limit (0 is returned if no limit line is set.)

{numeric 4}: Lower border value of the limit (0 is returned if no limit line is set.)

Examples

```
Dim Var as Variant
Ana.WriteString ":CALC1:LIM:REP:MARK1?", True
Var=Ana.ReadList(ASCIIType_R8, ",")
```

Related Commands

[:CALC:LIM](#)

[:CALC:LIM:REP:ALL](#)**Equivalent Softkey**

No equivalent key is available on the front panel.

COM Command Syntax (Internal Control Only)

```
SCPI.CALCULATE(Ch).SELECTED.LIMIT.REPORT.MARKER(Mk).ALL
```

:CALC<Ch>:LIM:REP:POIN**Type**

Query

Syntax

```
:CALCulate<Ch>[:SElected]:LIMit:REPort:POINts?
```

Description

This command returns the number of the failed points of the limit test.

Query Response

```
{ numeric } <newline> < ^END >
```

Examples

```
Dim Var as Long
Ana.WriteString ":CALC1:LIM:REP:POIN?", True
Var=Ana.ReadNumber
```

Related Commands[:CALC:LIM](#)[:CALC:LIM:REP](#)**Equivalent Softkey**

No equivalent key is available on the front panel.

COM Command Syntax (Internal Control Only)

```
SCPI.CALCULATE(Ch).SELECTED.LIMIT.REPORT.POINTS
```

:CALC<Ch>:MARK<Mk>**Type**

Command/Query

Syntax

```
:CALCulate<Ch>[:SElected]:MARKer<Mk>[:STATe] {ON|OFF|1|0}
```

```
:CALCulate<Ch>[:SElected]:MARKer<Mk>[:STATe]?
```

Description

This command turns ON/OFF the display of marker 1 to 9 (Mk) and reference marker (Mk: 10).

Variable

Parameter	Selection Option
------------------	------------------

E4990A Impedance Analyzer Help

Description	Marker On/Off
Data Type	Boolean type (Boolean)
Range	ON OFF 1 0
Preset Value	OFF

Query Response

{1|0} <newline> < ^END>

Examples

```
Dim Var as Integer
Ana.WriteString ":CALC1:MARK1 ON", True
Ana.WriteString ":CALC1:MARK1?", True
Var=Ana.ReadNumber
```

Related Commands

[:CALC:MARK:AOFF](#)

Equivalent Softkey

Marker > **Marker 1 to Marker 9, Reference Marker**

Marker > **Clear Marker Menu** > **Marker 1 to Marker 9, Reference Marker**

COM Command Syntax (Internal Control Only)

SCPI.CALCULATE(Ch).SELECTED.MARKER(Mk).STATE

:CALC<Ch>:MARK<Mk>:ACT

Type

Command

Syntax

:CALCulate<Ch>[:SElected]:MARKer<Mk>:ACTivate

Description

This command sets as active marker.

Examples

```
Ana.WriteString ":CALC1:MARK1:ACT", True
```

Related Commands

[:CALC:MARK](#)

Equivalent Softkey

Marker > **Marker 1 to Marker 9, Reference Marker**

COM Command Syntax (Internal Control Only)

SCPI.CALCULATE(Ch).SELECTED.MARKER(Mk).ACTIVATE

:CALC<Ch>:MARK:AOFF

Type

Command

Syntax

```
:CALCulate<Ch>[:SELEcted]:MARKer:AOff
```

Description

This command turns off all markers.

Examples

```
Ana.WriteString ":CALC1:MARK:AOff", True
```

Related Commands

[:CALC:MARK](#)

Equivalent Softkey

Marker > **Clear Marker Menu** > **All Off**

COM Command Syntax (Internal Control Only)

```
SCPI.CALCULATE(Ch).SELECTED.MARKER.AOFF
```

```
:CALC<Ch>:MARK:BWID
```

Type

Command/Query

Syntax

```
:CALCulate<Ch>[:SELEcted]:MARKer:BWIDth[:STATe] {ON|OFF|1|0}
```

```
:CALCulate<Ch>[:SELEcted]:MARKer:BWIDth[:STATe]?
```

Description

This command shows/hides the marker bandwidth.

Variable

Parameter	Selection Option
Description	Marker bandwidth On/Off status
Data Type	Boolean type (Boolean)
Range	ON OFF 1 0
Preset Value	OFF

Query Response

```
{1|0}<newline><^END>
```

Examples

```
Dim Var as Integer
Ana.WriteString ":CALC1:MARK1:BWID ON", True
```

E4990A Impedance Analyzer Help

```
Ana.WriteString ":CALC1:MARK1:BWID?", True  
Var=Ana.ReadNumber
```

Related Commands

[:CALC:MARK:BWID:DATA](#)

Equivalent Softkey

Marker Search > **Bandwidth**

COM Command Syntax (Internal Control Only)

```
SCPI.CALCULATE(Ch).SELECTED.MARKER.BWIDTH.STATE
```

:CALC<Ch>:MARK:BWID:DATA

Type

Query

Syntax

```
:CALCulate<Ch>[:SElected]:MARKer:BWIDth:DATA?
```

Description

This command reads the bandwidth search result of marker 1 to 9 (Mk) and reference marker (Mk: 10).

If the bandwidth search is impossible, an error occurs when executed and the object is ignored.

Query Response

```
{numeric 1}, {numeric 2}, {numeric 3}, {numeric 4}, {numeric 5},  
{numeric 6} <newline> <^END>
```

{numeric 1} : Bandwidth

{numeric 2} : Center point frequency of the 2 cutoff frequency points

{numeric 3} : Q value

{numeric 4} : marker value (peak value)

{numeric 5} : ΔL

{numeric 6} : ΔR

Examples

```
Dim Var as Variant  
Ana.WriteString ":CALC1:MARK:BWID:DATA?", True  
Var=Ana.ReadNumber
```

Related Commands

[:CALC:MARK:BWID](#)

Equivalent Softkey

No equivalent key is available on the front panel.

(Result on the screen for **Marker Search** > **Bandwidth**)

COM Command Syntax (Internal Control Only)

```
SCPI.CALCULATE(Ch).SELECTED.MARKER.BWIDTH.DATA
```

:CALC<Ch>:MARK<Mk>:BWID:FIX:VAL

Type

Command/Query

Syntax

:CALCulate<Ch>[:SElected]:MARKer<Mk>:BWIDth:FIXed:VALue <Value>

:CALCulate<Ch>[:SElected]:MARKer<Mk>:BWIDth:FIXed:VALue?

Description

This command sets/gets the marker bandwidth fixed value.

Variable

Parameter	Value
Description	Marker bandwidth fixed value
Data Type	Numeric type (Real)
Range	-500M ~ 500M
Preset Value	0
Unit	Depends on Measurement Format
Resolution	-

Query Response

{numeric} <newline> < ^END>

Examples

```
Dim Var as Double
Var= 10
Ana.WriteString ":CALC1:MARK1:BWID:FIX:VAL " & Str(Var), True
Ana.WriteString ":CALC1:MARK1:BWID:FIX:VAL?", True
Var=Ana.ReadNumber
```

Related Commands

[:CALC:MARK:BWID](#)

[:CALC:MARK:BWID:TYPE](#)

Equivalent Softkey

Marker Search > BW Fixed Value

COM Command Syntax (Internal Control Only)

SCPI.CALCULATE(Ch).SELECTED.MARKER(Mk).BWIDTH.FIXED.VALUE

:CALC<Ch>:MARK:BWID:TYPE

Type

Command/Query

Syntax

:CALCulate<Ch>[:SElected]:MARKer:BWIDth:TYPE
{DIVS2|MULS2|DIV2|MUL2|SUB|ADD|FIXed}

:CALCulate<Ch>[:SElected]:MARKer:BWIDth:TYPE?

Description

This command sets/gets a cutoff point in the marker bandwidth analysis function.

Variable

Parameter	Selection Option
Description	Cutoff point type
Data Type	Character string type (String)
Range	DIVS2: MkrVal/sqrt(2) MULS2: MkrVal*sqrt(2) DIV2: MkrVal/2 MUL2: MkrVal*2 SUB: MkrVal-Fixed ADD: MkrVal+Fixed FIXed: Fixed Value
Preset Value	FIXed

Query Response

{DIVS2|MULS2|DIV2|MUL2|SUB|ADD|FIX} <newline> < ^END>

Examples

```
Dim Var as String
Var= "DIVS2"
Ana.WriteString ":CALC1:MARK1:BWID:TYPE " & Var, True
Ana.WriteString ":CALC1:MARK1:BWID:TYPE?", True
Var=Ana.ReadString
```

Related Commands

[:CALC:MARK:BWID](#)

[:CALC:MARK:BWID:FIX:VAL](#)

Equivalent Softkey

Marker Search > Widths Def

COM Command Syntax (Internal Control Only)

SCPI.CALCULATE(Ch).SELECTED.MARKER.BWIDTH.TYPE

:CALC<Ch>:MARK<Mk>:COUP

Type

Command/Query

Syntax

:CALCulate<Ch>[:SElected]:MARKer:COUPle {ON|OFF|1|0}

:CALCulate<Ch>[:SElected]:MARKer:COUPle?

Description

This command turns marker couple/uncouple.

Variable

Parameter	Selection Option
Description	Marker couple/uncouple status
Data Type	Boolean type (Boolean)
Range	ON OFF 1 0
Preset Value	ON

Query Response

{1|0}<newline><^END>

Examples

```
Dim Var as Integer
Ana.WriteString ":CALC1:MARK1:COUP ON", True
Ana.WriteString ":CALC1:MARK1:COUP?", True
Var=Ana.ReadNumber
```

Related Commands

[:CALC:MARK](#)

Equivalent Softkey

Marker Function > Couple

COM Command Syntax (Internal Control Only)

SCPI.CALCULATE(Ch).SELECTED.MARKER.COUPLE

:CALC<Ch>:MARK:DISC

E4990A Impedance Analyzer Help

Type

Command/Query

Syntax

:CALCulate<Ch>[:SElected]:MARKer:DIScrete {ON|OFF|1|0}

:CALCulate<Ch>[:SElected]:MARKer:DIScrete?

Description

This command turns marker discrete mode On/Off.

Variable

Parameter	Selection Option
Description	Marker discrete mode On/Off status
Data Type	Boolean type (Boolean)
Range	ON OFF 1 0
Preset Value	OFF

Query Response

{1|0} <newline> < ^END>

Examples

```
Dim Var as Integer
Ana.WriteString ":CALC1:MARK:DISC ON", True
Ana.WriteString ":CALC1:MARK:DISC?", True
Var=Ana.ReadNumber
```

Related Commands

[:CALC:MARK:Y](#)

[:CALC:MARK:X](#)

Equivalent Softkey

Marker Function > Discrete

COM Command Syntax (Internal Control Only)

SCPI.CALCULATE(Ch).SELECTED.MARKER.DISCRETE

:CALC<Ch>:MARK:FUNC:DOM

Type

Command/Query

Syntax

:CALCulate<Ch>[:SElected]:MARKer:FUNCTION:DOMAIN[:STATE] {ON|OFF|1|0}

:CALCulate<Ch>[:SElected]:MARKer:FUNcTION:DOMain[:STATe]?

Description

This command sets/gets the search range state.

Variable

Parameter	Selection Option
Description	Search range On/Off state
Data Type	Boolean type (Boolean)
Range	ON OFF 1 0
Preset Value	OFF

Query Response

{1|0} <newline> < ^END>

Examples

```
Dim Var as Integer
Ana.WriteString ":CALC1:MARK:FUNC:DOM ON", True
Ana.WriteString ":CALC1:MARK:FUNC:DOM?", True
Var=Ana.ReadNumber
```

Related Commands

[:CALC:MARK:FUNC:DOM:COUP](#)

[:CALC:MARK:FUNC:DOM:STAR](#)

[:CALC:MARK:FUNC:DOM:STOP](#)

Equivalent Softkey

Marker Search > **Search Range** > **Search Range**

COM Command Syntax (Internal Control Only)

SCPI.CALCULATE(Ch).SELECTED.MARKER(MK).FUNCTION.DOMAIN.STATE

:CALC<Ch>:MARK:FUNC:DOM:COUP

Type

Command/Query

Syntax

```
:CALCulate<Ch>[:SElected]:MARKer:FUNcTION:DOMain:COUPle
{ON|OFF|1|0}
```

```
:CALCulate<Ch>[:SElected]:MARKer:FUNcTION:DOMain:COUPle?
```

Description

E4990A Impedance Analyzer Help

This command sets/gets the search range couple state.

Variable

Parameter	Selection Option
Description	Search range couple On/Off state
Data Type	Boolean type (Boolean)
Range	ON OFF 1 0
Preset Value	ON

Query Response

```
{1|0} <newline> < ^END >
```

Examples

```
Dim Var as Integer  
Ana.WriteString ":CALC1:MARK:FUNC:DOM:COUP ON", True  
Ana.WriteString ":CALC1:MARK:FUNC:DOM:COUP?", True  
Var=Ana.ReadNumber
```

Related Commands

[:CALC:MARK:FUNC:DOM](#)

Equivalent Softkey

Marker Search > **Search Range** > **Couple**

COM Command Syntax (Internal Control Only)

```
SCPI.CALCULATE(Ch).SELECTED.MARKER.FUNCTION.DOMAIN.COUPLE
```

```
:CALC<Ch>:MARK:FUNC:DOM:STAR
```

Type

Command/Query

Syntax

```
:CALCulate<Ch>[:SElected]:MARKer:FUNction:DOMain:STARt <Value>
```

```
:CALCulate<Ch>[:SElected]:MARKer:FUNction:DOMain:STARt?
```

Description

This command sets/gets the start of search range.

Variable

Parameter	Value
Description	Start value

Data Type	Numeric type (Real)
Range	-500G ~ 500G
Preset Value	0
Unit	Hz V A
Resolution	-

Query Response

```
{ numeric } <newline> < ^END >
```

Examples

```
Dim Var as Double
Var= -500000000000
Ana.WriteString ":CALC1:MARK:FUNC:DOM:STAR " & Str(Var), True
Ana.WriteString ":CALC1:MARK:FUNC:DOM:STAR?", True
Var=Ana.ReadNumber
```

Related Commands

[:CALC:MARK:FUNC:DOM:STOP](#)

[:CALC:MARK:FUNC:DOM](#)

Equivalent Softkey

Marker Search > Search Range > Start

COM Command Syntax (Internal Control Only)

```
SCPI.CALCULATE(Ch).SELECTED.MARKER.FUNCTION.DOMAIN.START
```

```
:CALC<Ch>:MARK:FUNC:DOM:STOP
```

Type

Command/Query

Syntax

```
:CALCulate<Ch>[:SElected]:MARKer:FUNctioN:DOMain:STOP <Value>
```

```
:CALCulate<Ch>[:SElected]:MARKer:FUNctioN:DOMain:STOP?
```

Description

This command sets/gets the stop of search range.

Variable

Parameter	Value
Description	Stop value

E4990A Impedance Analyzer Help

Data Type	Numeric type (Real)
Range	-500G ~ 500G
Preset Value	0
Unit	Hz V A
Resolution	-

Query Response

{ numeric } <newline> < ^END >

Examples

```
Dim Var as Double
Var= -500000000000
Ana.WriteString ":CALC1:MARK:FUNC:DOM:STOP " & Str(Var), True
Ana.WriteString ":CALC1:MARK:FUNC:DOM:STOP?", True
Var=Ana.ReadNumber
```

Related Commands

[:CALC:MARK:FUNC:DOM:STAR](#)

[:CALC:MARK:FUNC:DOM](#)

Equivalent Softkey

Marker Search > **Search Range** > **Stop**

COM Command Syntax (Internal Control Only)

SCPI.CALCULATE(Ch).SELECTED.MARKER.FUNCTION.DOMAIN.STOP

:CALC<Ch>:MARK<Mk>:FUNC:EXEC

Type

Command

Syntax

:CALCulate<Ch>[:SElected]:MARKer<Mk>:FUNCTION:EXECute

Description

This command executes the marker search.

Examples

```
Ana.WriteString ":CALC1:MARK1:FUNC:EXEC", True
```

Related Commands

[:CALC:MARK:FUNC:MULT:TYPE](#)

[:CALC:MARK:FUNC:TYPE](#)

Equivalent Softkey

Marker Search > **Max** | **Min**

Marker Search > **Peak** > **Search Peak**

Marker Search > **Target** > **Search Target**

Marker Search > **Multi Peak** > **Search Multi Peak**

Marker Search > **Multi Target** > **Search Multi Target**

These softkeys operation can be done by the following two commands:

- Max/Min/Peak/Target [:CALC:MARK:FUNC:TYPE](#) and
:CALC:MARK:FUNC:EXEC.
- Multi Peak/Multi Target [:CALC:MARK:FUNC:MULT:TYPE](#) and
:CALC:MARK:FUNC:EXEC.

COM Command Syntax (Internal Control Only)

SCPI.CALCULATE(Ch).SELECTED.MARKER(Mk).FUNCTION.EXECUTE

:CALC<Ch>:MARK:FUNC:MULT:PEXC

Type

Command/Query

Syntax

:CALCulate<Ch>[:SElected]:MARKer:FUNction:MULTi:PEXCursion
<Value>

:CALCulate<Ch>[:SElected]:MARKer:FUNction:MULTi:PEXCursion?

Description

This command sets/gets the peak excursion value.

Variable

Parameter	Value
Description	Peak excursion value
Data Type	Numeric type (Real)
Range	0 ~ 500M
Preset Value	3
Unit	Depends on Measurement Format
Resolution	-

Query Response

E4990A Impedance Analyzer Help

{numeric} <newline> < ^END>

Examples

```
Dim Var as Double
Var= 10
Ana.WriteString ":CALC1:MARK:FUNC:MULT:PEXC " & Str(Var), True
Ana.WriteString ":CALC1:MARK:FUNC:MULT:PEXC?", True
Var=Ana.ReadNumber
```

Related Commands

[:CALC:MARK:FUNC:EXEC](#)

[:CALC:MARK:FUNC:MULT:TYPE](#)

[:CALC:MARK:FUNC:MULT:PPOL](#)

Equivalent Softkey

Marker Search > Multi Peak > Peak Excursion

COM Command Syntax (Internal Control Only)

SCPI.CALCULATE(Ch).SELECTED.MARKER.FUNCTION.MULTI.PEXCURSION

:CALC<Ch>:MARK:FUNC:MULT:PPOL

Type

Command/Query

Syntax

:CALCulate<Ch>[:SElected]:MARKer:FUNction:MULTi:PPOLarity
{POSitive|NEGative|BOTH}

:CALCulate<Ch>[:SElected]:MARKer:FUNction:MULTi:PPOLarity?

Description

This command sets/gets the peak polarity type.

Variable

Parameter	Selection Option
Description	Polarity type
Data Type	Character string type (String)
Range	POSitive NEGative BOTH
Preset Value	POSitive

Query Response

{POS|NEG|BOTH} <newline> < ^END>

Examples

```
Dim Var as String
Var= "POS"
Ana.WriteString ":CALC1:MARK:FUNC:MULT:PPOL " & Var, True
Ana.WriteString ":CALC1:MARK:FUNC:MULT:PPOL?", True
Var=Ana.ReadString
```

Related Commands

Equivalent Softkey

No equivalent key is available on the front panel.

COM Command Syntax (Internal Control Only)

SCPI.CALCULATE(Ch).SELECTED.MARKER.FUNCTION.MULTI.PPOLARITY

:CALC<Ch>:MARK:FUNC:MULT:TARG

Type

Command/Query

Syntax

:CALCulate<Ch>[:SElected]:MARKer:FUNctioN:MULTi:TARGet <Value>

:CALCulate<Ch>[:SElected]:MARKer:FUNctioN:MULTi:TARGet?

Description

This command sets/gets the target value for multiple search.

Variable

Parameter	Value
Description	Target value
Data Type	Numeric type (Real)
Range	-500M ~ 500M
Preset Value	0
Unit	Depends on Measurement Format
Resolution	-

Query Response

{ numeric } <newline> < ^END>

Examples

```
Dim Var as Double
Var= 100
Ana.WriteString ":CALC1:MARK:FUNC:MULT:TARG " & Str(Var), True
```

E4990A Impedance Analyzer Help

```
Ana.WriteString ":CALC1:MARK:FUNC:MULT:TARG?", True  
Var=Ana.ReadNumber
```

Related Commands

[:CALC:MARK:FUNC:MULT:TYPE](#)

[:CALC:MARK:FUNC:MULT:TTR](#)

[:CALC:MARK:FUNC:EXEC](#)

Equivalent Softkey

Marker Search > Multi Target > Target Value

COM Command Syntax (Internal Control Only)

```
SCPI.CALCULATE(Ch).SELECTED.MARKER.FUNCTION.MULTI.TARGET
```

:CALC<Ch>:MARK:FUNC:MULT:TRAC

Type

Command/Query

Syntax

```
:CALCulate<Ch>[:SElected]:MARKer:FUNction:MULTi:TRACking  
{ON|OFF|1|0}
```

```
:CALCulate<Ch>[:SElected]:MARKer:FUNction:MULTi:TRACking?
```

Description

This command turns the tracking search capability On/Off for multiple search.

Variable

Parameter	Selection Option
Description	Tracking Search On/Off status
Data Type	Boolean type (Boolean)
Range	ON OFF 1 0
Preset Value	OFF

Query Response

```
{1|0} <newline> < ^END >
```

Examples

```
Dim Var as Integer  
Ana.WriteString ":CALC1:MARK:FUNC:MULT:TRAC ON", True  
Ana.WriteString ":CALC1:MARK:FUNC:MULT:TRAC?", True  
Var=Ana.ReadNumber
```

Related Commands[:CALC:MARK:FUNC:EXEC](#)[:CALC:MARK:FUNC:MULT:TYPE](#)**Equivalent Softkey****Marker Search > Tracking****COM Command Syntax (Internal Control Only)**

SCPI.CALCULATE(Ch).SELECTED.MARKER.FUNCTION.MULTI.TRACKING

:CALC<Ch>:MARK:FUNC:MULT:TTR**Type**

Command/Query

Syntax:CALCulate<Ch>[:SELEcted]:MARKer:FUNctioN:MULTi:TTRansition
{POSitive|NEGative|BOTH}

:CALCulate<Ch>[:SELEcted]:MARKer:FUNctioN:MULTi:TTRansition?

Description

This command sets/gets the target transition type for multiple search.

Variable

Parameter	Selection Option
Description	Transition type
Data Type	Character string type (String)
Range	POSitive NEGative BOTH
Preset Value	BOTH

Query Response

{POS|NEG|BOTH} <newline> < ^END>

Examples

```
Dim Var as String
Var= "POS"
Ana.WriteString ":CALC1:MARK:FUNC:MULT:TTR " & Var, True
Ana.WriteString ":CALC1:MARK:FUNC:MULT:TTR?", True
Var=Ana.ReadString
```

Related Commands[:CALC:MARK:FUNC:MULT:TYPE](#)[:CALC:MARK:FUNC:MULT:TARG](#)

E4990A Impedance Analyzer Help

Equivalent Softkey

No equivalent key is available on the front panel.

COM Command Syntax (Internal Control Only)

SCPI.CALCULATE(Ch).SELECTED.MARKER.FUNCTION.MULTI.TTRANSITION

:CALC<Ch>:MARK:FUNC:MULT:TYPE

Type

Command/Query

Syntax

:CALCulate<Ch>[:SElected]:MARKer:FUNction:MULTi:TYPE
{OFF|PEAK|TARGet}

:CALCulate<Ch>[:SElected]:MARKer:FUNction:MULTi:TYPE?

Description

This command sets/gets the marker search type for multiple search.

Variable

Parameter	Selection Option
Description	Marker search type
Data Type	Character string type (String)
Range	OFF PEAK TARGet
Preset Value	OFF

Query Response

{OFF|PEAK|TARG} <newline> < ^END >

Examples

```
Dim Var as String
Var= "OFF"
Ana.WriteString ":CALC1:MARK:FUNC:MULT:TYPE " & Var, True
Ana.WriteString ":CALC1:MARK:FUNC:MULT:TYPE?", True
Var=Ana.ReadString
```

Related Commands

[:CALC:MARK:FUNC:EXEC](#)

Equivalent Softkey

Marker Search > Multi Peak > Search Multi Peak

Marker Search > Multi Target > Search Multi Target

COM Command Syntax (Internal Control Only)

SCPI.CALCULATE(Ch).SELECTED.MARKER.FUNCTION.MULTI.TYPE

:CALC<Ch>:MARK<Mk>:FUNC:PEXC

Type

Command/Query

Syntax

:CALCulate<Ch>[:SELEcted]:MARKer<Mk>:FUNction:PEXCursion <Value>

:CALCulate<Ch>[:SELEcted]:MARKer<Mk>:FUNction:PEXCursion?

Description

This command sets/gets the [peak excursion value](#) with marker 1 to 9 (MK: 1-9) and reference marker (Mk: 10).

Variable

Parameter	Value
Description	Peak excursion value
Data Type	Numeric type (Real)
Range	0 ~ 500M
Preset Value	3
Unit	Depending on measurement value
Resolution	-

Query Response

{numeric} <newline> < ^END>

Examples

```
Dim Var as Double
Var= 5
Ana.WriteString ":CALC1:MARK1:FUNC:PEXC " & Str(Var), True
Ana.WriteString ":CALC1:MARK1:FUNC:PEXC?", True
Var=Ana.ReadNumber
```

Related Commands

[:CALC:MARK:FUNC:TYPE](#)

[:CALC:MARK:FUNC:PPOL](#)

[:CALC:MARK:FUNC:EXEC](#)

Equivalent Softkey

Marker Search > Peak > Peak Excursion

COM Command Syntax (Internal Control Only)

SCPI.CALCULATE(Ch).SELECTED.MARKER(Mk).FUNCTION.PEXCURSION

:CALC<Ch>:MARK<Mk>:FUNC:PPOL

Type

Command/Query

Syntax

:CALCulate<Ch>[:SELEcted]:MARKer<Mk>:FUNction:PPOLarity
{POSitive|NEGative|BOTH}

:CALCulate<Ch>[:SELEcted]:MARKer<Mk>:FUNction:PPOLarity?

Description

This command sets/gets the peak polarity type with marker 1 to 9 (MK:1-9) and reference marker (Mk:10).

Variable

Parameter	Selection Option
Description	Peak polarity type
Data Type	Character string type (String)
Range	POSitive NEGative BOTH
Preset Value	POSitive

Query Response

{POS|NEG|BOTH}<newline><^END>

Examples

```
Dim Var as String
Var= "POS"
Ana.WriteString ":CALC1:MARK1:FUNC:PPOL " & Var, True
Ana.WriteString ":CALC1:MARK1:FUNC:PPOL?", True
Var=Ana.ReadString
```

Related Commands

[:CALC:MARK:FUNC:TYPE](#)

[:CALC:MARK:FUNC:PEXC](#)

[:CALC:MARK:FUNC:EXEC](#)

Equivalent Softkey

Marker Search > Peak > Peak Polarity

COM Command Syntax (Internal Control Only)

SCPI.CALCULATE(Ch).SELECTED.MARKER(Mk).FUNCTION.PPOLARITY

:CALC<Ch>:MARK<Mk>:FUNC:TARG

Type

Command/Query

Syntax

:CALCulate<Ch>[:SElected]:MARKer<Mk>:FUNcTion:TARGet <Value>

:CALCulate<Ch>[:SElected]:MARKer<Mk>:FUNcTion:TARGet?

Description

This command sets/gets the target value with marker 1 to 9 (MK:1-9) and reference marker (Mk:10).

Variable

Parameter	Value
Description	Target value
Data Type	Numeric type (Real)
Range	-500M ~ 500M
Preset Value	0
Unit	Depends on measurement format
Resolution	-

Query Response

{ numeric } <newline> < ^END >

Examples

```
Dim Var as Double
Var= 100
Ana.WriteString ":CALC1:MARK1:FUNC:TARG " & Str(Var), True
Ana.WriteString ":CALC1:MARK1:FUNC:TARG?", True
Var=Ana.ReadNumber
```

Related Commands

[:CALC:MARK:FUNC:TYPE](#)[:CALC:MARK:FUNC:TTR](#)

[:CALC:MARK:FUNC:EXEC](#)

Equivalent Softkey

Marker Search > Peak > Target Value

COM Command Syntax (Internal Control Only)

SCPI.CALCULATE(Ch).SELECTED.MARKER(Mk).FUNCTION.TARGET

:CALC<Ch>:MARK<Mk>:FUNC:TRAC

Type

Command/Query

Syntax

:CALCulate<Ch>[:SElected]:MARKer<Mk>:FUNction:TRACking
{ON|OFF|1|0}

:CALCulate<Ch>[:SElected]:MARKer<Mk>:FUNction:TRACking?

Description

This command turns the tracking capability On/Off with marker 1 to 9 (MK: 1-9) and reference marker (Mk: 10).

Variable

Parameter	Selection Option
Description	Tracking Search On/Off status
Data Type	Boolean type (Boolean)
Range	ON OFF 1 0
Preset Value	OFF

Query Response

{1|0} <newline> <^END>

Examples

```
Dim Var as Integer
Ana.WriteString ":CALC1:MARK1:FUNC:TRAC ON", True
Ana.WriteString ":CALC1:MARK1:FUNC:TRAC?", True
Var=Ana.ReadNumber
```

Related Commands

[:CALC:MARK:FUNC:EXEC](#)

[:CALC:MARK:FUNC:TYPE](#)

Equivalent Softkey

Marker Search > Tracking

COM Command Syntax (Internal Control Only)

SCPI.CALCULATE(Ch).SELECTED.MARKER(Mk).FUNCTION.TRACKING

:CALC<Ch>:MARK<Mk>:FUNC:TTR

Type

Command/Query

Syntax

:CALCulate<Ch>[:SELEcted]:MARKer<Mk>:FUNction: TTRansition
{ POSitive|NEGative|BOTH}

:CALCulate<Ch>[:SELEcted]:MARKer<Mk>:FUNction: TTRansition?

Description

This command sets/gets target transition type with marker 1 to 9 (MK: 1-9) and reference marker (Mk: 10).

Variable

Parameter	Selection Option
Description	Transition type
Data Type	Character string type (String)
Range	POSitive NEGative BOTH
Preset Value	BOTH

Query Response

{ POS|NEG|BOTH} <newline> < ^END>

Examples

```
Dim Var as String
Var= "POS"
Ana.WriteString ":CALC1:MARK1:FUNC:TTR " & Var, True
Ana.WriteString ":CALC1:MARK1:FUNC:TTR?", True
Var=Ana.ReadString
```

Related Commands

[:CALC: MARK: FUNC: TARG](#)

[:CALC: MARK: FUNC: TYPE](#)

Equivalent Softkey

Marker Search > Peak > Target Transition

COM Command Syntax (Internal Control Only)

SCPI.CALCULATE(Ch).SELECTED.MARKER(Mk).FUNCTION.TTRANSITION

:CALC<Ch>:MARK<Mk>:FUNC:TYPE

Type

Command/Query

Syntax

:CALCulate<Ch>[:SElected]:MARKer<Mk>:FUNction:TYPE
{MAXimum|MINimum|PEAK|LPEak|RPEak|TARGet|LTARget|RTARget}

:CALCulate<Ch>[:SElected]:MARKer<Mk>:FUNction:TYPE?

Description

This command selects the marker search type with marker 1 to 9 (MK:1-9) and reference marker (Mk:10).

Variable

Parameter	Selection Option
Description	Marker search type
Data Type	Character string type (String)
Range	<p>MAXimum: Sets the search type to the maximum value.</p> <p>MINimum: Sets the search type to the minimum value.</p> <p>PEAK: Sets the search type to the peak search.</p> <p>LPEak: Sets the search type to the peak search to the left from the marker position.</p> <p>RPEak: Sets the search type to the peak search to the right from the marker position.</p> <p>TARGet: Sets the search type to the target search.</p> <p>LTARget: Sets the search type to the target search to the left from the marker position.</p> <p>RTARget: Sets the search type to the target search to the right from the marker position.</p>
Preset Value	MAXimum

Query Response

{MAX|MIN|PEAK|LPE|RPE|TARG|LTAR|RTAR} <newline> < ^END>

Examples

```
Dim Var as String
Var= "MAX"
Ana.WriteString ":CALC1:MARK1:FUNC:TYPE " & Var, True
Ana.WriteString ":CALC1:MARK1:FUNC:TYPE?", True
Var=Ana.ReadString
```

Related Commands

- [:CALC:PAR:SEL](#)
- [:CALC:MARK:FUNC:PEXC](#)
- [:CALC:MARK:FUNC:PPOL](#)
- [:CALC:MARK:FUNC:TARG](#)
- [:CALC:MARK:FUNC:TTR](#)
- [:CALC:MARK:FUNC:EXEC](#)

Equivalent Softkey

- Marker Search > Max | Min**
- Marker Search > Peak > Search Peak**
- Marker Search > Target > Search Target**

These softkeys operation can be done the two commands,
:CALC:MARK:FUNC:TYPE and [:CALC:MARK:FUNC:EXEC](#).

COM Command Syntax (Internal Control Only)

SCPI.CALCULATE(Ch).SELECTED.MARKER(Mk).FUNCTION.TYPE

:CALC<Ch>:MARK:MATH:STAT

Type

Command/Query

Syntax

```
:CALCulate<Ch>[:SElected]:MARKer:MATH:STATistics[:STATe]
{ON|OFF|1|0}
```

```
:CALCulate<Ch>[:SElected]:MARKer:MATH:STATistics[:STATe]?
```

Description

This command shows/hides marker statistics.

Variable

Parameter	Selection Option
Description	Marker statistics On/Off status
Data Type	Boolean type (Boolean)
Range	ON OFF 1 0

Preset Value	OFF
---------------------	-----

Query Response

{1|0} <newline> < ^END>

Examples

```
Dim Var as Integer
Ana.WriteString ":CALC1:MARK:MATH:STAT ON", True
Ana.WriteString ":CALC1:MARK:MATH:STAT?", True
Var=Ana.ReadNumber
```

Related Commands

[:CALC:MARK:MATH:STAT:DATA](#)

Equivalent Softkey

Marker Function > Statistics

COM Command Syntax (Internal Control Only)

SCPI.CALCULATE(Ch).SELECTED.MARKER.MATH.STATISTICS.STATE

:CALC<Ch>:MARK:MATH:STAT:DATA

Type

Query

Syntax

:CALCulate<Ch>[:SElected]:MARKer:MATH:STATistics:DATA?

Description

This command returns the marker statistics value.

Query Response

```
{numeric1}, {numeric2}, {numeric3}, {numeric4} <newline> < ^END>
{numeric1}: Span
{numeric2}: Mean
{numeric3}: Standard Deviation
{numeric4}: Peak to peak
```

Examples

```
Dim Var as Variant
Ana.WriteString ":CALC1:MARK:MATH:STAT:DATA?", True
Var=Ana.ReadNumber
```

Related Commands

[:CALC:MARK:MATH:STAT](#)

Equivalent Softkey

No equivalent key is available on the front panel.
(Result on screen for **Marker Function > Statistics**)

COM Command Syntax (Internal Control Only)

```
SCPI.CALCULATE(Ch).SELECTED.MARKER.MATH.STATISTICS.DATA
```

```
:CALC<Ch>:MARK:REF
```

Type

Command/Query

Syntax

```
:CALCulate<Ch>[:SELEcted]:MARKer:REFerence[:STATe] {ON|OFF|1|0}
```

```
:CALCulate<Ch>[:SELEcted]:MARKer:REFerence[:STATe]?
```

Description

This command turns on/off the delta marker mode.

Variable

Parameter	Selection Option
Description	Delta marker mode On/Off status
Data Type	Boolean type (Boolean)
Range	ON OFF 1 0
Preset Value	OFF

Query Response

```
{1|0}<newline><^END>
```

Examples

```
Dim Var as Integer
Ana.WriteString ":CALC1:MARK:REF ON", True
Ana.WriteString ":CALC1:MARK:REF?", True
Var=Ana.ReadNumber
```

Related Commands

[:CALC:PAR:SEL](#)

Equivalent Softkey

Marker > Ref Marker Mode

COM Command Syntax (Internal Control Only)

```
SCPI.CALCULATE(Ch).SELECTED.MARKER.REFERENCE.STATE
```

```
:CALC<Ch>:MARK<Mk>:SET
```

Type

Command

Syntax

E4990A Impedance Analyzer Help

:CALCulate<Ch>[:SElected]:MARKer<Mk>:SET
{CENTer|START|STOP|RLEVel|ZOOM}

Description

This command sets the value at the position of marker 1 to 9 (Mk) and reference marker (Mk:10) to the value of the stimulus.

Variable

Parameter	Selection Option
Description	Type of stimulus value
Data Type	Character string type (String)
Range	"START": Sets the sweep start value to the stimulus value at the marker position. "STOP": Sets the sweep stop value to the stimulus value at the marker position. "CENTer": Sets the sweep center value to the stimulus value at the marker position. "RLEVel": Sets the reference line value to the response value at the marker position. "ZOOM": Sets the span value in order to zoom the span by specified zoom aperture.
Preset Value	-

Examples

```
Dim Var as String  
Var= "CENT"  
Ana.WriteString ":CALC1:MARK1:SET " & Var, True
```

Related Commands

[:CALC:PAR:SEL](#)

[:CALC:MARK:REF](#)

[:CALC:MARK:ZAP](#)

Equivalent Softkey

Marker Fctn > **Marker** > **Start**

Marker Fctn > **Marker** > **Stop**

Marker Fctn > **Marker** > **Center**

Marker Fctn > **Marker** > **Reference**

Marker Fctn > Marker > Zoom

COM Command Syntax (Internal Control Only)

SCPI.CALCULATE(Ch).SELECTED.MARKER(Mk).SET

:CALC<Ch>:MARK<Mk>:X

Type

Command/Query

Syntax

:CALCulate<Ch>[:SElected]:MARKer<Mk>:X[:DATA] <Value>

:CALCulate<Ch>[:SElected]:MARKer<Mk>:X[:DATA]?

Description

This command sets/gets the stimulus value for marker 1 to 9 (Mk) and reference marker (Mk: 10).

Variable

Parameter	Value
Description	Marker X-axis position value
Data Type	Numeric type (Real)
Range	-
Preset Value	20
Unit	Depending on the stimulus parameter
Resolution	-

Query Response

{ numeric } <newline> < ^END >

Examples

```
Dim Var as Double
Ana.WriteString ":CALC1:MARK1:X ON", True
Ana.WriteString ":CALC1:MARK1:X?", True
Var=Ana.ReadNumber
```

Related Commands

[:CALC:MARK:Y](#)

Equivalent Softkey

Marker > Marker 1 to Marker 9, Reference Marker

E4990A Impedance Analyzer Help

When performing the operation from the front panel, turn ON the marker and set the stimulus value at the same time.

COM Command Syntax (Internal Control Only)

SCPI.CALCULATE(Ch).SELECTED.MARKER(Mk).X.DATA

:CALC<Ch>:MARK<Mk>:X:POS

Type

Command/Query

Syntax

:CALCulate<Ch>[:SELEcted]:MARKer<Mk>:X:POSition <Value>

:CALCulate<Ch>[:SELEcted]:MARKer<Mk>:X:POSition?

Description

This command sets/gets the measurement point number of the selected marker (Mk: 1-9) and reference marker (Mk: 10).

Variable

Parameter	Value
Description	Point number
Data Type	Numeric type (Real)
Range	1 to Number of Point
Preset Value	1

Query Response

{ numeric } <newline> < ^END >

Examples

```
Dim Var as Double
Var = 100
Ana.WriteString ":CALC1:MARK1:X:POS " & Str(Var), True
Ana.WriteString ":CALC1:MARK1:X:POS?", True
Var=Ana.ReadNumber
```

Related Commands

[:CALC:MARK:X](#)

[:SENS:SWE:POIN](#)

Equivalent Softkey

No equivalent key is available on the front panel.

COM Command Syntax (Internal Control Only)

SCPI.CALCULATE(Ch).SELECTED.MARKER(Mk).X.POSITION

:CALC<Ch>:MARK:XUN

Type

Command/Query

Syntax

:CALCulate<Ch>[:SELEcted]:MARKer:XUNit {STIM|TIME|RFRReq}

:CALCulate<Ch>[:SELEcted]:MARKer:XUNit?

Description

This command sets/gets the marker x-axis display method for the active trace.

Variable

Parameter	Selection Option
Description	Marker x-axis display method
Data Type	Character string type (String)
Range	STIM: Sweep parameter TIME: Time RFRReq: Relaxation time
Preset Value	STIM

Query Response

{STIM|TIME|RFR}<newline><^END>

Examples

```
Dim Var as String
Var= "STIM"
Ana.WriteString ":CALC1:MARK:XUN " & Var, True
Ana.WriteString ":CALC1:MARK:XUN?", True
Var=Ana.ReadString
```

Related Commands

[:CALC:MARK:ACT](#)

Equivalent Softkey

Marker Function > X Unit

COM Command Syntax (Internal Control Only)

SCPI.CALCULATE(Ch).SELECTED.MARKER.XUNIT

:CALC<Ch>:MARK<Mk>:Y

E4990A Impedance Analyzer Help

Type

Query

Syntax

:CALCulate<Ch>[:SElected]:MARKer<Mk>:Y?

Description

This command gets the marker y-axis value.

Query Response

{numeric1 (primary)}, {numeric2 (secondary)}<newline><^END>

The secondary value is available when the format is 2 dimension such as R-X.

Examples

```
Dim Var as Variant
Var= STIM
Ana.WriteString ":CALC1:MARK1:Y?", True
Var=Ana.ReadList
```

Related Commands

[:CALC:MARK:X](#)

Equivalent Softkey

No equivalent key is available on the front panel.

COM Command Syntax (Internal Control Only)

SCPI.CALCULATE(Ch).SELECTED.MARKER(Mk).Y

:CALC<Ch>:MARK:ZAP

Type

Command/Query

Syntax

:CALCulate<Ch>[:SElected]:MARKer:ZAPerture <Value>

:CALCulate<Ch>[:SElected]:MARKer:ZAPerture?

Description

This command sets/gets the marker zooming aperture.

Variable

Parameter	Value
Description	Marker zooming aperture
Data Type	Numeric type (Real)
Range	10m ~ 100

Preset Value	10
Unit	%
Resolution	10m

Query Response

```
{ numeric } <newline> < ^END >
```

Examples

```
Dim Var as Double
Var= 0.01
Ana.WriteString ":CALC1:MARK:ZAP " & Str(Var), True
Ana.WriteString ":CALC1:MARK:ZAP?", True
Var=Ana.ReadNumber
```

Related Commands

[:CALC:MARK:SET](#)

Equivalent Softkey

Marker Function > **Zooming Aperture**

COM Command Syntax (Internal Control Only)

```
SCPI.CALCULATE(Ch).SELECTED.MARKER.ZAPERTURE
```

```
:CALC<Ch>:MATH:FUNC
```

Type

Command/Query

Syntax

```
:CALCulate<Ch>[:SElected]:MATH:FUNCTION
{NORMAL|DIVide|MULTIply|SUBTract|ADD}
```

```
:CALCulate<Ch>[:SElected]:MATH:FUNCTION?
```

Description

This command selects the math operation type. Causes error when memory trace is not valid, except NORM. When NOP is changed, operation type is set to NORM.

Variable

Parameter	Selection Option
Description	Math operation type
Data Type	Character string type (String)

E4990A Impedance Analyzer Help

Range	<p>"NORMal": Data (no math). "DIVide": Data / Mem. "MULTiply": Data × Mem. "SUBTract": Data - Mem. "ADD": Data + Mem.</p> <p>Where Data is the measurement data (corrected data array) and Mem is the data stored in the memory trace (corrected memory array).</p>
Preset Value	NORMal

Query Response

```
{ NORM|DIV|MULT|SUBT|ADD} <newline>< ^END>
```

Examples

```
Dim Var as String
Var= "NORM"
Ana.WriteString ":CALC1:MATH:FUNC " & Var, True
Ana.WriteString ":CALC1:MATH:FUNC?", True
Var=Ana.ReadString
```

Related Commands

[:CALC:MATH:MEM](#)

Equivalent Softkey

Display > **Data Math**

COM Command Syntax (Internal Control Only)

```
SCPI.CALCULATE(Ch).SELECTED.MATH.FUNCTION
```

:CALC<Ch>:MATH:MEM

Type

Command

Syntax

```
:CALCulate<Ch>[:SElected]:MATH:MEMorize
```

Description

This command copies the corrected data trace to the memory trace.

Examples

```
Ana.WriteString ":CALC1:MATH:MEM", True
```

Related Commands

[:CALC:MATH:FUNC](#)

Equivalent Softkey

Display > Data -> Mem

COM Command Syntax (Internal Control Only)

SCPI.CALCULATE(Ch).SELECTED.MATH.MEMORIZE

:CALC<Ch>:MATH:OFFS

Type

Command/Query

Syntax

:CALCulate<Ch>[:SElected]:MATH:OFFSet <Value>

:CALCulate<Ch>[:SElected]:MATH:OFFSet?

Description

This command sets/gets the math offset data

Variable

Parameter	Value
Description	Offset value
Data Type	Numeric type (Real)
Range	-100M ~ 100M
Preset Value	0
Unit	Depends on measurement format
Resolution	-

Query Response

{numeric} <newline> < ^END>

Examples

```
Dim Var as Double
Var= 1000
Ana.WriteString ":CALC1:MATH:OFFS " & Str(Var), True
Ana.WriteString ":CALC1:MATH:OFFS?", True
Var=Ana.ReadNumber
```

Related Commands

[:CALC:MATH:FUNC](#)

Equivalent Softkey

Display > Data Math Offset

E4990A Impedance Analyzer Help

COM Command Syntax (Internal Control Only)

SCPI.CALCULATE(Ch).SELECTED.MATH.OFFSET

:CALC<Ch>:MST

Type

Command/Query

Syntax

:CALCulate<Ch>[:SElected]:MSTatistics[:STATe] {ON|OFF|1|0}

:CALCulate<Ch>[:SElected]:MSTatistics[:STATe]?

Description

This command shows/hides the marker statistics.

Variable

Parameter	Selection Option
Description	Marker statistics On/Off status
Data Type	Boolean type (Boolean)
Range	ON OFF 1 0
Preset Value	OFF

Query Response

{1|0}<newline><^END>

Examples

```
Dim Var as Integer
Ana.WriteString ":CALC1:MST ON", True
Ana.WriteString ":CALC1:MST?", True
Var=Ana.ReadNumber
```

Related Commands

[:CALC:MST:DATA](#)

Equivalent Softkey

Marker Function > Statistics

COM Command Syntax (Internal Control Only)

SCPI.CALCULATE(Ch).SELECTED.MSTATISTICS.STATE

:CALC<Ch>:MST:DATA

Type

Query

Syntax

:CALCulate<Ch>[:SElected]:MStatistics:DATA?

Description

This command gets the marker statistics value. The statistical values contain: mean value, standard deviation and the difference between the maximum value and the minimum value.

Query Response

```
{numeric1}, {numeric2}, {numeric3} <newline> < ^END>
```

```
{numeric 1} : Mean value
```

```
{numeric 2} : Standard deviation
```

```
{numeric 3} : Difference between the maximum value and the minimum value (Peak to Peak)
```

Examples

```
Dim Var as Variant
Ana.WriteString ":CALC1:MST:DATA?", True
Var=Ana.ReadList
```

Related Commands

[:CALC:MST](#)

Equivalent Softkey

No equivalent key is available on the front panel.

(Result on screen for **Marker Function** > **Statistics**)

COM Command Syntax (Internal Control Only)

```
SCPI.CALCULATE(Ch).SELECTED.MSTATISTICS.DATA
```

:CALC<Ch>:PAR:COUNT

Type

Command/Query

Syntax

```
:CALCulate<Ch>:PARAmeter:COUNT <Value>
```

```
:CALCulate<Ch>:PARAmeter:COUNT?
```

Description

This command sets/gets the number of traces.

Variable

Parameter	Value
Description	Number of traces.
Data Type	Numeric type (Integer)

E4990A Impedance Analyzer Help

Range	1 2 3 4
Preset Value	2

Query Response

{numeric} <newline> < ^END>

Examples

```
Dim Var as Long
Var= 4
Ana.WriteString ":CALC1:PAR:COUN " & Str(Var), True
Ana.WriteString ":CALC1:PAR:COUN?", True
Var=Ana.ReadNumber
```

Related Commands

[:CALC:PAR:SEL](#)

Equivalent Softkey

Display > **Num Of Traces**

COM Command Syntax (Internal Control Only)

SCPI.CALCULATE(Ch).PARAMETER.COUNT

:CALC<Ch>:PAR<Tr>:DEF

Type

Command/Query

Syntax

```
:CALCulate<Ch>:PARAmeter<Tr>:DEFine
{Z|Y|R|X|G|B|LS|LP|CS|CP|RS|RP|Q|D|TZ|TY|VAC|IAC|VDC|IDC|IMP|ADM}
```

```
:CALCulate<Ch>:PARAmeter<Tr>:DEFine?
```

Description

This command sets/gets the measurement parameter. The VDC or IDC can be selected only at bias sweep or log bias sweep.

Variable

Parameter	Selection Option
Description	Measurement parameter
Data Type	Character string type (String)
Range	Z: Absolute impedance value Y: Absolute admittance

	R: Equivalent series resistance X: Equivalent series reactance G: Equivalent parallel conductance B: Equivalent parallel susceptance LS: Equivalent series inductance LP: Equivalent parallel inductance CS: Equivalent series capacitance CP: Equivalent parallel capacitance RS: Equivalent series resistance RP: Equivalent parallel resistance Q: Q value D: Dissipation factor TZ: Impedance phase TY: Absolute phase VAC: OSC level (Voltage) IAC: OSC level (Current) VDC: DC Bias (Voltage) IDC: DC Bias (Current) IMP: Impedance (complex value) ADM: Admittance (complex value)
Preset Value	Z

Query Response

```
{Z|Y|R|X|G|B|LS|LP|CS|CP|RS|RP|Q|D|TZ|TY|VAC|IAC|VDC|IDC|IMP|ADM} <newline> < ^END >
```

Examples

```
Dim Var as String
Var= "Z"
Ana.WriteString ":CALC1:PAR1:DEF " & Var, True
Ana.WriteString ":CALC1:PAR1:DEF?", True
Var=Ana.ReadString
```

Related Commands

[:SENS:SWE:TYPE](#)

Equivalent Softkey

Meas > **Trace 1**, **Trace 2**, **Trace 3** or **Trace 4**

COM Command Syntax (Internal Control Only)

```
SCPI.CALCULATE(Ch).PARAMETER(Tr).DEFINE
:CALC<Ch>:PAR<Tr>:SEL
```

E4990A Impedance Analyzer Help

Type

Command

Syntax

:CALCulate<Ch>:PARAmeter<Tr>:SELEct

Description

This command sets the selected trace as active trace. Use [:DISP:WIND:ACT](#) to activate the channel.

Examples

Ana.WriteString ":CALC1:PAR1:SEL", True

Related Commands

[:CALC:PAR:COUN](#)

[:DISP:WIND:ACT](#)

Equivalent Softkey

Trace Next, Trace Prev

COM Command Syntax (Internal Control Only)

SCPI.CALCULATE(Ch).PARAMETER(Tr).SELECT

:CALC<Ch>:UNIT:ANGL

Type

Command/Query

Syntax

:CALCulate<Ch>[:SELEcted]:UNIT:ANGLE {DEG|RAD}

:CALCulate<Ch>[:SELEcted]:UNIT:ANGLE?

Description

This command sets/gets Phase Unit for the selected channel. All traces in a channel has the same setting.

Variable

Parameter	Selection Option
Description	Phase Unit
Data Type	Character string type (String)
Range	DEG RAD
Preset Value	DEG

Query Response

```
{ DEG|RAD} <newline> < ^END>
```

Examples

```
Dim Var as String
Var= "DEG"
Ana.WriteString ":CALC1:UNIT:ANGL " & Var, True
Ana.WriteString ":CALC1:UNIT:ANGL?", True
Var=Ana.ReadString
```

Related Commands

[:CALC:PAR:DEF](#)

Equivalent Softkey

Format > **Phase Unit**

COM Command Syntax (Internal Control Only)

```
SCPI.CALCULATE(Ch).SELECTED.UNIT.ANGLE
```

CONTROL

:CONT:HAND:A

Type

Command

Syntax

```
:CONTrol:HANDler:A[:DATA] <Value>
```

Description

This command sets/gets information of output port A (A0 to A7) of the handler I/O. Port information is output as 8-bit binary data using A0 as LSB and A7 as MSB.

Variable

Parameter	Value
Description	Port information (output)
Data Type	Numeric type (Integer)
Range	0 ~ 255

Examples

```
Dim Var as Long
Var= 10
Ana.WriteString ":CONT:HAND:A " & Str(Var), True
```

Equivalent Softkey

No equivalent key is available on the front panel.

COM Command Syntax (Internal Control Only)

```
SCPI.CONTROL.HANDLER.A.DATA
```

:CONT:HAND:B

Type

Command

Syntax

:CONTrol:HANDler:B[:DATA] <Value>

Description

This command sets/gets information of output port B (B0 to B7) of the handler I/O. Port information is output as 8-bit binary data using B0 as LSB and B7 as MSB.

The bit 6 of the data outputted by this project is ignored when outputting the INDEX signal is turned ON (specifying True with the [:CONT:HAND:IND:STAT](#) object).

The bit 7 of the data outputted by this project is ignored when outputting the READY FOR TRIGGER signal is turned ON (specifying True with the [:CONT:HAND:RTR:STAT](#) object).

Variable

Parameter	Value
Description	Port information (output)
Data Type	Numeric type (Integer)
Range	0 ~ 255

Examples

```
Dim Var as Long
Var= 11
Ana.WriteString ":CONT:HAND:B " & Str(Var), True
```

Equivalent Softkey

No equivalent key is available on the front panel.

COM Command Syntax (Internal Control Only)

SCPI.CONTROL.HANDLER.B.DATA

:CONT:HAND:C

Type

Command/Query

Syntax

:CONTrol:HANDler:C[:DATA] <Value>

:CONTrol:HANDler:C[:DATA]?

Description

When input/output port C of the handler I/O is set to the output port, it outputs port information to the output port C (C0 to C3).

When input/output port C of the handler I/O is set to the input port, it reads out port information inputted to port C (C0 to C3).

Port information is input/output as 4-bit binary data, using C0 as LSB and C3 as MSB.

Variable

Parameter	Value
Description	Port information (input/output)
Data Type	Numeric type (Integer)
Range	0 ~ 15

Query Response

```
{ numeric} <newline> < ^END>
```

Examples

```
Dim Var as Long
Var= 15
Ana.WriteString ":CONT:HAND:C " & Str(Var), True
Ana.WriteString ":CONT:HAND:C?", True
Var=Ana.ReadNumber
```

Related Commands

[:CONT:HAND:C:MODE](#)

Equivalent Softkey

No equivalent key is available on the front panel.

COM Command Syntax (Internal Control Only)

```
SCPI.CONTROL.HANDLER.C.DATA
```

:CONT:HAND:C:MODE

Type

Command/Query

Syntax

```
:CONTrol:HANDler:C:MODE {INPut|OUTPut}
```

```
:CONTrol:HANDler:C:MODE?
```

Description

This command sets/gets the input/output direction of port C of the handler I/O.

E4990A Impedance Analyzer Help

Variable

Parameter	Selection Option
Description	Input/output direction of port C
Data Type	Character string type (String)
Range	INPut OUTPut
Preset Value	INPut

Query Response

```
{ INP|OUTP } <newline> < ^END >
```

Examples

```
Dim Var as String  
Var= "INPut"  
Ana.WriteString ":CONT:HAND:C:MODE " & Var, True  
Ana.WriteString ":CONT:HAND:C:MODE?", True  
Var=Ana.ReadString
```

Related Commands

[:CONT:HAND:C](#)

Equivalent Softkey

No equivalent key is available on the front panel.

COM Command Syntax (Internal Control Only)

```
SCPI.CONTROL.HANDLER.C.MODE
```

:CONT:HAND:D

Type

Command/Query

Syntax

```
:CONTrol:HANDler:D[:DATA] <Value>
```

```
:CONTrol:HANDler:D[:DATA]?
```

Description

When input/output port D of the handler I/O is set to the output port, it outputs port information to output port D (D0 to D3).

When input/output port D of the handler I/O is set to the input port, it reads out port information to input to port D (D0 to D3).

Port information is output as 4-bit binary data using D0 as LSB and D3 as MSB.

Variable

Parameter	Value
Description	Port information (input/output)
Data Type	Numeric type (Integer)
Range	0 ~ 15

Query Response

{ numeric } <newline> < ^END >

Examples

```
Dim Var as Long
Var= 0
Ana.WriteString ":CONT:HAND:D" & Str(Var), True
Ana.WriteString ":CONT:HAND:D?", True
Var=Ana.ReadNumber
```

Related Commands

[:CONT:HAND:D:MODE](#)

Equivalent Softkey

No equivalent key is available on the front panel.

COM Command Syntax (Internal Control Only)

SCPI.CONTROL.HANDLER.D.DATA

:CONT:HAND:D:MODE

Type

Command/Query

Syntax

:CONTrol:HANDler:D:MODE {INPut|OUTPut}

:CONTrol:HANDler:D:MODE?

Description

This command sets/gets the input/output direction of port D of the handler I/O.

Variable

Parameter	Selection Option
Description	Input/output direction of port D
Data Type	Character string type (String)

E4990A Impedance Analyzer Help

Range	INPut OUTPut
Preset Value	INPut

Query Response

{ INP|OUTP } <newline> < ^END >

Examples

```
Dim Var as String
Var= "INPut"
Ana.WriteString ":CONT:HAND:D:MODE " & Var, True
Ana.WriteString ":CONT:HAND:D:MODE?", True
Var=Ana.ReadString
```

Related Commands

[:CONT:HAND:D](#)

Equivalent Softkey

No equivalent key is available on the front panel.

COM Command Syntax (Internal Control Only)

SCPI.CONTROL.HANDLER.D.MODE

:CONT:HAND:E

Type

Command/Query

Syntax

:CONTrol:HANDler:E[:DATA] <Value>

:CONTrol:HANDler:E[:DATA]?

Description

When input/output port E (port C + port D) of the handler I/O is set to the output port, it outputs port information to output port E (C0 to D3).

When input/output port E of the handler I/O is set to the input port, it reads out port information inputted to port E (C0 to D3).

Port information is output as 8-bit binary data using C0 as LSB and D3 as MSB.

Variable

Parameter	Value
Description	Port information (input/output)
Data Type	Numeric type (Integer)

Range	0 ~ 255
--------------	---------

Query Response

{ numeric } <newline> < ^END>

Examples

```
Dim Var as Long
Var= 0
Ana.WriteString ":CONT:HAND:E " & Str(Var), True
Ana.WriteString ":CONT:HAND:E?", True
Var=Ana.ReadNumber
```

Related Commands

[:CONT:HAND:C](#)

[:CONT:HAND:C:MODE](#)

[:CONT:HAND:D](#)

[:CONT:HAND:D:MODE](#)

Equivalent Softkey

No equivalent key is available on the front panel.

COM Command Syntax (Internal Control Only)

SCPI.CONTROL.HANDLER.E.DATA

:CONT:HAND:F**Type**

Command

Syntax

:CONTrol:HANDler:F[:DATA] <Value>

Description

Outputs port information to output port F (port A + port B) of the handler I/O. Port information is output as 16-bit binary using A0 as LSB and B7 as MSB.

The bit 14 of the data output by this project is ignored when outputting the INDEX signal is turned ON (specifying True with the [:CONT:HAND:IND:STAT](#)).

The bit 15 of the data output by this project is ignored when outputting the READY FOR TRIGGER signal is turned ON (specifying True with the [:CONT:HAND:RTR:STAT](#)).

Variable

Parameter	Value
-----------	-------

E4990A Impedance Analyzer Help

Description	Port information (output)
Data Type	Numeric type (Integer)
Range	0 ~ 65535

Examples

```
Dim Var as Long
Var= 0
Ana.WriteString ":CONT:HAND:F " & Str(Var), True
```

Related Commands

[:CONT:HAND:A](#)

[:CONT:HAND:B](#)

Equivalent Softkey

No equivalent key is available on the front panel.

COM Command Syntax (Internal Control Only)

SCPI.CONTROL.HANDLER.F.DATA

:CONT:HAND:IND:STAT

Type

Command/Query

Syntax

:CONTrol:HANDler[:EXTension]:INDex:STATe {ON|OFF|1|0}

:CONTrol:HANDler[:EXTension]:INDex:STATe?

Description

Turns ON/OFF output of the INDEX signal to B6 of the handler I/O.

When you use port B6 as the output port, turn OFF the INDEX signal output. When output of the INDEX signal is turned ON, the bit 6 of the data output by the [:CONT:HAND:B](#) (the bit 14 of the data outputted by the [:CONT:HAND:F](#)) is ignored.

Variable

Parameter	Selection Option
Description	State of the INDEX signal output
Data Type	Boolean type (Boolean)
Range	ON OFF 1 0

Preset Value	OFF
---------------------	-----

Query Response

```
{ 1|0} <newline> < ^END>
```

Examples

```
Dim Var as Integer
Ana.WriteString ":CONT:HAND:IND:STAT ON", True
Ana.WriteString ":CONT:HAND:IND:STAT?", True
Var=Ana.ReadNumber
```

Related Commands

[:CONT:HAND:RTR:STAT](#)

Equivalent Softkey

No equivalent key is available on the front panel.

COM Command Syntax (Internal Control Only)

```
SCPI.CONTROL.HANDLER.EXTENSION.INDEX.STATE
```

```
:CONT:HAND:OUTP<Pt>
```

Type

Command/Query

Syntax

```
:CONTrol:HANDler:OUTPut<Pt>[:DATA] <Value>
```

```
:CONTrol:HANDler:OUTPut<Pt>[:DATA]?
```

Description

This command sets/gets data to OUTPUT1 or OUTPUT2 of the handler I/O.

Variable

Parameter	Value
Description	OUTPUT terminal number
Data Type	Numeric type (Integer)
Range	0 ~ 1

Query Response

```
{ numeric} <newline> < ^END>
```

Examples

E4990A Impedance Analyzer Help

```
Dim Var as Long
Var= 1
Ana.WriteString ":CONT:HAND:OUTP1 " & Str(Var), True
Ana.WriteString ":CONT:HAND:OUTP1?", True
Var=Ana.ReadNumber
```

Equivalent Softkey

No equivalent key is available on the front panel.

COM Command Syntax (Internal Control Only)

```
SCPI.CONTROL.HANDLER.OUTPUT(Pt).DATA
```

:CONT:HAND:RTR:STAT

Type

Command/Query

Syntax

```
:CONTrol:HANDler[:EXTension]:RTRigger:STATe {ON|OFF|1|0}
```

```
:CONTrol:HANDler[:EXTension]:RTRigger:STATe?
```

Description

This command turns ON/OFF the output of READY FOR TRIGGER signal to B7 of the handler I/O.

When you use port B7 as the output port, turn OFF the READY FOR TRIGGER signal output. When outputting the READY FOR TRIGGER signal is turned ON, the bit 7 of the data output by the [:CONT:HAND:B](#) (the bit 15 of the data output by the [:CONT:HAND:F](#)) is ignored.

Variable

Parameter	Selection Option
Description	Status of the READY FOR TRIGGER signal output
Data Type	Boolean type (Boolean)
Range	ON OFF 1 0
Preset Value	OFF

Query Response

```
{1|0} <newline> < ^END >
```

Examples

```
Dim Var as Integer
Ana.WriteString ":CONT:HAND:RTR:STAT ON", True
```

```
Ana.WriteString ":CONT:HAND:RTR:STAT?", True
Var=Ana.ReadNumber
```

Related Commands

[:CONT:HAND:IND:STAT](#)

Equivalent Softkey

No equivalent key is available on the front panel.

COM Command Syntax (Internal Control Only)

SCPI.CONTROL.HANDLER.EXTENSION.RTRIGGER.STATE

DISPLAY

:DISP:ANN:FREQ

Type

Command/Query

Syntax

```
:DISPlay:ANNotation:FREQuency[:STATe] {ON|OFF|1|0}
```

```
:DISPlay:ANNotation:FREQuency[:STATe]?
```

Description

This command show/hide the frequency information display on the LCD display.

Variable

Parameter	Selection Option
Description	Status of the frequency display
Data Type	Boolean type (Boolean)
Range	ON OFF 1 0
Preset Value	ON

Query Response

```
{1|0} <newline> < ^END>
```

Examples

```
Dim Var as Boolean
Var= 1
Ana.WriteString ":DISP:ANN:FREQ " & Str(Var), True
Ana.WriteString ":DISP:ANN:FREQ?", True
Aar=Ana.ReadNumber
```

Equivalent Softkey

Display > Frequency

COM Command Syntax (Internal Control Only)

SCPI.DISPLAY.ANNOTATION.FREQUENCY.STATE

:DISP:CCL

Type

Command

Syntax

:DISPlay:CClear

Description

This command clears the caution/error message displayed in the status bar (at the bottom of the LCD display).

Examples

Ana.WriteString ":DISP:CCL", True

Equivalent Softkey

No equivalent key is available on the front panel.

COM Command Syntax (Internal Control Only)

SCPI.DISPLAY.CCLEAR

:DISP:CLOC

Type

Command/Query

Syntax

:DISPlay:CLOCK {ON|OFF|1|0}

:DISPlay:CLOCK?

Description

This command show/hide the clock display in the instrument status bar (at the right bottom of the LCD display).

Variable

Parameter	Selection Option
Description	ON/OFF of the clock display
Data Type	Boolean type (Boolean)
Range	ON OFF 1 0
Preset Value	ON

Query Response

```
{1|0} <newline> < ^END >
```

Examples

```
Dim Var as Boolean
Var= 1
Ana.WriteString ":DISP:CLOC" & Str(Var), True
Ana.WriteString ":DISP:CLOC?", True
Var=Ana.ReadNumber
```

Equivalent Softkey

System > Misc Setup > Clock Setup > Show Clock

COM Command Syntax (Internal Control Only)

```
SCPI.DISPLAY.CLOCK
```

```
:DISP:COL<Dnum>:BACK
```

Type

Command/Query

Syntax

```
:DISPlay:COLor<Dnum>:BACK <Value1>, <Value2>, <Value3>
```

```
:DISPlay:COLor<Dnum>:BACK?
```

Description

This command sets/gets the background color.

<Dnum> Normal display: 1, Inverted display: 2

Variable

Parameter	Value1
Description	Red
Data Type	Numeric type (Integer)
Range	0 to 5
Preset Value	0

Parameter	Value2
Description	Green
Data Type	Numeric type (Integer)

E4990A Impedance Analyzer Help

Range	0 to 5
Preset Value	0

Parameter	Value3
Description	Blue
Data Type	Numeric type (Integer)
Range	0 to 5
Preset Value	0

Query Response

{numeric 1}, {numeric 2}, {numeric 3} <newline> <^END>

Examples

```
Dim Var as Variant
Ana.WriteString ":DISP:COL:BACK 5,5,5", True
Ana.WriteString ":DISP:COL:BACK?", True
Var=Ana.ReadList
```

Related Commands

[:DISP:COL:RES](#)

Equivalent Softkey

System > **Misc Setup** > **Display Setup** > **Color Setup** > **Normal | Invert** > **Background**

COM Command Syntax (Internal Control Only)

SCPI.DISPLAY.COLOR(Dnum).BACK

:DISP:COL<Dnum>:GRAT<Gnum>

Type

Command/Query

Syntax

```
:DISPlay:COLor<Dnum>:GRATicule<Gnum> <Value1>, <Value2>,
<Value3>
:DISPlay:COLor<Dnum>:GRATicule<Gnum>?
```

Description

This command sets/gets the color of the graticule label.

<Dnum> Normal display: 1, Inverted display: 2

<Gnum> Outer frame line of the graph: 1, Color of the grid line of the graph: 2

Variable

Parameter	Value1
Description	Red
Data Type	Numeric type (Integer)
Range	0 to 5
Preset Value	3

Parameter	Value2
Description	Green
Data Type	Numeric type (Integer)
Range	0 to 5
Preset Value	3

Parameter	Value3
Description	Blue
Data Type	Numeric type (Integer)
Range	0 to 5
Preset Value	3

E4990A Impedance Analyzer Help

Query Response

{numeric 1}, {numeric 2}, {numeric 3} <newline> <^END>

Example

```
Dim Var as Variant
Ana.WriteString ":DISP:COL:GRAT1 5, 5, 5", True
Ana.WriteString ":DISP:COL:GRAT1?", True
Var=Ana.ReadList
```

Related Commands

[:DISP:COL:RES](#)

Equivalent Softkey

System > **Misc Setup** > **Display Setup** > **Color Setup** > **Normal | Invert** > **Graticule Main**

System > **Misc Setup** > **Display Setup** > **Color Setup** > **Normal | Invert** > **Graticule Sub**

COM Command Syntax (Internal Control Only)

SCPI.DISPLAY.COLOR(Dnum).GRATICULE(Gnum)

:DISP:COL<Dnum>:LIM<Lnum>

Type

Command/Query

Syntax

:DISPlay:COLor<Dnum>:LIMit<Lnum> <Value1>, <Value2>, <Value3>

:DISPlay:COLor<Dnum>:LIMit<Lnum>?

Description

This command sets/gets the fail display color used for the limit test result and the color of the limit line.

<Lnum> Fail display color: 1, limit line color: 2

<Dnum> Normal display: 1, Inverted display: 2.

Variable

Parameter	Value1
Description	Red
Data Type	Numeric type (Integer)
Range	0 to 5

Preset Value	5 for Lnum=1, 3 for Lnum=2
---------------------	----------------------------

Parameter	Value2
Description	Green
Data Type	Numeric type (Integer)
Range	0 to 5
Preset Value	0

Parameter	Value3
Description	Blue
Data Type	Numeric type (Integer)
Range	0 to 5
Preset Value	0

Query Response

{numeric 1}, {numeric 2}, {numeric 3} <newline> <^END>

Examples

```
Dim Var as Variant
Ana.WriteString ":DISP:COL:LIM1 0, 1, 3", True
Ana.WriteString ":DISP:COL:LIM1?", True
Var=Ana.ReadList
```

Related Commands**Equivalent Softkey**

System > **Misc Setup** > **Display Setup** > **Color Setup** > **Normal | Invert** > **Limit Fail**

System > **Misc Setup** > **Display Setup** > **Color Setup** > **Normal | Invert** > **Limit Line**

COM Command Syntax (Internal Control Only)

SCPI.DISPLAY.COLOR(Dnum).LIMIT(Lnum)

:DISP:COL<Dnum>:RES

Type

Command

Syntax

:DISPlay:COLor<Dnum>:RESet

Description

This command resets the display color settings for all the items to the factory preset state.

<Dnum> Normal display: 1, Inverted display: 2

Examples

Ana.WriteString ":DISP:COL1:RES", True

Related Commands

Equivalent Softkey

System > Misc Setup > Display Setup > Color Setup > Normal | Invert > Reset Color > OK

COM Command Syntax (Internal Control Only)

SCPI.DISPLAY.COLOR(Dnum).RESET

:DISP:COL<Dnum>:TRAC<Tr>:DATA

Type

Command/Query

Syntax

:DISPlay:COLor<Dnum>:TRACe<Tr>:DATA <Value1>, <Value2>, <Value3>

:DISPlay:COLor<Dnum>:TRACe<Tr>:DATA?

Description

This command sets/gets the color of the data trace.

<Dnum> Normal display: 1, Inverted display: 2.

Variable

Parameter	Value1
Description	Red
Data Type	Numeric type (Integer)
Range	0 to 5

Parameter	Value2
Description	Green
Data Type	Numeric type (Integer)
Range	0 to 5

Parameter	Value3
Description	Blue
Data Type	Numeric type (Integer)
Range	0 to 5

Query Response

```
{ numeric 1 }, { numeric 2 }, { numeric 3 } <newline> < ^END >
```

Examples

```
Dim Var as Variant
Ana.WriteString ":DISP:COL:TRAC1:DATA 5, 5, 0", True
Ana.WriteString ":DISP:COL:TRAC1:DATA?", True
Var=Ana.ReadList
```

Related Commands

[:DISP:COL:RES](#)

Equivalent Softkey

System > **Misc Setup** > **Display Setup** > **Color Setup** > **Normal | Invert** > **Data Trace 1** to **Data Trace 4**

COM Command Syntax (Internal Control Only)

```
SCPI.DISPLAY.COLOR(Dnum).TRACE(Tr).DATA
```

```
:DISP:COL<Dnum>:TRAC<Tr>:MEM
```

Type

Command/Query

Syntax

E4990A Impedance Analyzer Help

:DISPlay:COLor<Dnum>:TRACe<Tr>:MEMory <Value1>, <Value2>, <Value3>

:DISPlay:COLor<Dnum>:TRACe<Tr>:MEMory?

Description

This command sets/gets the color of the memory trace.

<Dnum> Normal display: 1, Inverted display: 2.

Variable

Parameter	Value1
Description	Red
Data Type	Numeric type (Integer)
Range	0 to 5

Parameter	Value2
Description	Green
Data Type	Numeric type (Integer)
Range	0 to 5

Parameter	Value3
Description	Blue
Data Type	Numeric type (Integer)
Range	0 to 5

Query Response

{numeric 1}, {numeric 2}, {numeric 3} <newline> <^END>

Examples

```
Dim Var as Variant
Ana.WriteString ":DISP:COL:TRAC1:MEM 3, 3, 0", True
Ana.WriteString ":DISP:COL:TRAC1:MEM?", True
Var=Ana.ReadList
```

Related Commands

[:DISP:COL:RES](#)

Equivalent Softkey

System > **Misc Setup** > **Display Setup** > **Color Setup** > **Normal | Invert** > **Mem Trace 1** to **Mem Trace 4**

COM Command Syntax (Internal Control Only)

```
SCPI.DISPLAY.COLOR(Dnum).TRACE(Tr).MEMORY
```

:DISP:ECHO

Type

Command

Syntax

```
:DISP:play:ECHO[:DATA] <Value>
```

Description

This command displays a character strings in the echo window. This command is different from ECHO command as it displays a single character string.

Variable

Parameter	Value
Description	String you want to display in the echo window.
Data Type	Character string type (String)
Range	254 characters

Examples

```
Dim Var as String
Ana.WriteString ":DISP:ECHO & Var, True
```

Related Commands

[:DISP:TABL](#)

[:DISP:TABL:TYPE](#)

[:DISP:ECHO:CLE](#)

Equivalent Softkey

No equivalent key is available on the front panel.

COM Command Syntax (Internal Control Only)

E4990A Impedance Analyzer Help

SCPI.DISPLAY.ECHO.DATA

:DISP:ECHO:CLE

Type

Command

Syntax

:DISPlay:ECHO:CLEar

Description

This command clears all character strings displayed in the echo window.

Examples

Ana.WriteString ":DISPlay:ECHO:CLEar", True

Related Commands

[:DISP:ECHO](#)

Equivalent Softkey

Macro Setup > **Clear Echo**

COM Command Syntax (Internal Control Only)

SCPI.DISPLAY.ECHO.CLEAR

:DISP:ENAB

Type

Command/Query

Syntax

:DISPlay:ENABLE {ON|OFF|1|0}

:DISPlay:ENABLE?

Description

This command enable/disable the display update on the measurement screen.

Variable

Parameter	Selection Option
Description	ON/OFF of the display update of the measurement screen
Data Type	Boolean type (Boolean)
Range	ON OFF 1 0
Preset Value	ON

Query Response

{1|0} <newline> < ^END>

Examples

```
Dim Var as Integer
Ana.WriteString ":DISP:ENAB ON", True
Ana.WriteString ":DISP:ENAB?", True
Var=Ana.ReadNumber
```

Equivalent Softkey

Display > Update

COM Command Syntax (Internal Control Only)

SCPI.DISPLAY.ENABLE

:DISP:FSIG

Type

Command/Query

Syntax

:DISPlay:FSIGn {ON|OFF|1|0}

:DISPlay:FSIGn?

Description

This command turns ON/OFF the large "Fail" display on the LCD screen when the limit test fails.

Variable

Parameter	Selection Option
Description	ON/OFF of the "Fail" display when the limit test fails
Data Type	Boolean type (Boolean)
Range	ON OFF 1 0
Preset Value	ON

Query Response

{1|0} <newline> < ^END>

Examples

```
Dim Var as Integer
Ana.WriteString ":DISP:FSIG ON", True
Ana.WriteString ":DISP:FSIG?", True
Var=Ana.ReadNumber
```

Related Commands

[:CALC:LIM](#)

Equivalent Softkey

Analysis > Limit Test > Fail Sign

COM Command Syntax (Internal Control Only)

SCPI.DISPLAY.FSIGN

:DISP:IMAG

Type

Command/Query

Syntax

:DISPlay:IMAGe {NORMal|INVert}

:DISPlay:IMAGe?

Description

This command selects the image type of the LCD display.

Variable

Parameter	Selection Option
Description	Display type of the LCD display
Data Type	Character string type (String)
Range	NORMal: Normal color INVert: Invert color
Preset Value	NORMal

Query Response

{NORM|INV}<newline><^END>

Examples

```
Dim Var as String
Var= "NORMal"
Ana.WriteString ":DISP:IMAG" & Var, True
Ana.WriteString ":DISP:IMAG?", True
Var=Ana.ReadString
```

Equivalent Softkey

Display > Invert Color

COM Command Syntax (Internal Control Only)

SCPI.DISPLAY.IMAGE

:DISP:MAX**Type**

Command/Query

Syntax

:DISPlay:MAXimize {ON|OFF|1|0}

:DISPlay:MAXimize?

Description

This command turns ON/OFF the window maximization of the active channel.

Only the window of the active channel is maximized on the LCD display and the windows of the other channels are not displayed.

Variable

Parameter	Selection Option
Description	ON/OFF of the window maximization
Data Type	Boolean type (Boolean)
Range	ON OFF 1 0
Preset Value	OFF

Query Response

{1|0} <newline> < ^END >

Examples

```
Dim Var as Integer
Ana.WriteString ":DISP:MAX ON", True
Ana.WriteString ":DISP:MAX?", True
Var=Ana.ReadNumber
```

Related Commands

[:DISP:WIND:ACT](#)

Equivalent Softkey

Channel Max

COM Command Syntax (Internal Control Only)

SCPI.DISPLAY.MAXIMIZE

:DISP:SKEY

E4990A Impedance Analyzer Help

Type

Command/Query

Syntax

:DISPlay:SKEY[:STATe] {ON|OFF|1|0}

:DISPlay:SKEY[:STATe]?

Description

This command show/hide the display of the softkey menu bar.

Variable

Parameter	Selection Option
Description	ON/OFF of the softkey menu bar display
Data Type	Boolean type (Boolean)
Range	ON OFF 1 0
Preset Value	ON

Query Response

{1|0} <newline> < ^END>

Examples

```
Dim Var as Integer
Ana.WriteString ":DISP:SKEY ON", True
Ana.WriteString ":DISP:SKEY?", True
Var=Ana.ReadNumber
```

Equivalent Softkey

Entry Off (Softkey On/Off)

COM Command Syntax (Internal Control Only)

SCPI.DISPLAY.SKEY.STATE

:DISP:SPL

Type

Command/Query

Syntax

:DISPlay:SPLit

{D1|D1_2|D12|D1_2_3|D12_34|D1_1_2|D112|D12_33|D13_23|D123|D1
1_23|D12_13|D1234|D1_2_3_4}

:DISPlay:SPLit?

Description

This command split the display layout of the channel windows on the LCD display.

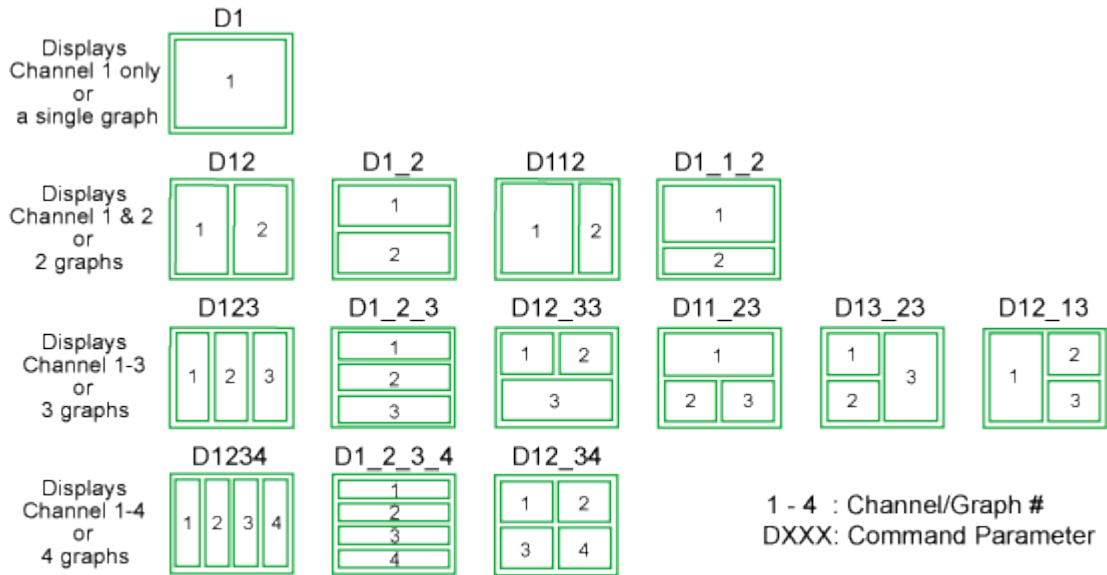

e5061b027

Variable

Parameter	Selection Option
Description	Layout of channel windows
Data Type	Character string type (String)
Range	D1 D1_2 D12 D1_2_3 D12_34 D1_1_2 D112 D12_33 D13_23 D123 D1_1_23 D12_13 D1234 D1_2_3_4
Preset Value	D1

Query Response

```
{D1|D1_2|D12|D1_2_3|D12_34|D1_1_2|D112|D12_33|D13_23|D123|D1_1_23|D12_13|D1234|D1_2_3_4}<newline><^END>
```

Examples

```
Dim Var as String
Var= "D1"
```

E4990A Impedance Analyzer Help

```
Ana.WriteString ":DISP:SPL " & Var, True  
Ana.WriteString ":DISP:SPL?", True  
Var=Ana.ReadString
```

Related Commands

[:DISP:WIND:ACT](#)

[:DISP:WIND:SPL](#)

Equivalent Softkey

Display > **Allocate Channels** > **{Display Layout}**

COM Command Syntax (Internal Control Only)

SCPI.DISPLAY.SPLIT

:DISP:TABL

Type

Command/Query

Syntax

:DISPlay:TABLE[:STATe] {ON|OFF|1|0}

:DISPlay:TABLE[:STATe]?

Description

This command shows/hides the list table of the window that appears in the lower part of the LCD display (specified by [:DISP:TABL:TYPE](#)).

Variable

Parameter	Selection Option
Description	ON/OFF of the list table of the window that appears in the lower part of the LCD display
Data Type	Boolean type (Boolean)
Range	ON OFF 1 0
Preset Value	OFF

Query Response

{1|0} <newline> < ^END >

Examples

```
Dim Var as Integer  
Ana.WriteString ":DISP:TABL ON", True
```

```
Ana.WriteString ":DISP:TABL?", True
Var=Ana.ReadNumber
```

Related Commands

[:DISP:TABL:TYPE](#)

[:DISP:TABL:POS](#)

Equivalent Softkey

Marker Fctn > **Marker Table**

Analysis > **Limit Test** > **Edit Limit Line**

Sweep Setup > **Edit Segment Table**

Macro Setup > **Echo Window**

[:DISP:TABL:TYPE](#) specifies the table type.

COM Command Syntax (Internal Control Only)

SCPI.DISPLAY.TABLE.STATE

:DISP:TABL:POS

Type

Query

Syntax

:DISPlay:TABLE:POSition[:RECTangle]?

Description

This command get/returns the rectangle position of list table.

Variable

Query Response

{numeric 1}, {numeric 2}, {numeric 3}, {numeric 4} <newline> <^END>

- {numeric 1} : coordinates X position of top left of Table Area.
- {numeric 2} : coordinates Y position of top left of Table Area.
- {numeric 3} : coordinates X position of bottom right of Table Area.
- {numeric 4} : coordinates Y position of bottom right of Table Area.

Examples

Dim Var as Variant

```
Ana.WriteString ":DISP:TABL:POS?", True
Var=Ana.ReadNList
```

Related Commands

[:DISP:TABL](#)

[:DISP:TABL:TYPE](#)

E4990A Impedance Analyzer Help

Equivalent Softkey

No equivalent key is available on the front panel.

COM Command Syntax (Internal Control Only)

SCPI.DISPLAY.TABLE.POSITION.RECTANGLE

:DISP:TABL:TYPE

Type

Command/Query

Syntax

:DISPlay:TABLE:TYPE {MARKer|LIMit|SEGMent|ECHO}

:DISPlay:TABLE:TYPE?

Description

This command selects the table type in the window.

Variable

Parameter	Selection Option
Description	Table
Data Type	Character string type (String)
Range	MARKer: Marker list LIMit: Limit table SEGMent: Segment table ECHO: Echo window
Preset Value	MARKer

Query Response

{MARK|LIM|SEGM|ECHO} <newline> < ^END >

Examples

```
Dim Var as String
Var= "MARKer"
Ana.WriteString ":DISP:TABL:TYPE " & Var, True
Ana.WriteString ":DISP:TABL:TYPE?", True
Var=Ana.ReadString
```

Related Commands

[:DISP:TABL](#)

[:DISP:TABL:POS](#)

Equivalent Softkey

Marker Fctn > **Marker Table****Analysis** > **Limit Test** > **Edit Limit Line****Sweep Setup** > **Edit Segment Table****Macro Setup** > **Echo Window**

COM Command Syntax (Internal Control Only)

SCPI.DISPLAY.TABLE.TYPE

:DISP:UPD

Type

Command

Syntax

:DISPlay:UPDate[:IMMediate]

Description

This command executes the display update once when the display update of the LCD screen is set to OFF (specifying False with the [:DISP:ENAB](#)).

Examples

Ana.WriteString ":DISP:UPD", True

Related Commands

[:DISP:ENAB](#)

Equivalent Softkey

No equivalent key is available on the front panel.

COM Command Syntax (Internal Control Only)

SCPI.DISPLAY.UPDATE.IMMEDIATE

:DISP:WIND<Ch>:ACT

Type

Command

Syntax

:DISPlay:WINDow<Ch>:ACTivate

Description

This command specifies the active channel. You can set only a channel displayed to the active channel. If this object is used to set a channel not displayed to the active channel, an error occurs when executed and the object is ignored.

Use [:CALC:PAR:SEL](#) to activate the trace.

Examples

Ana.WriteString ":DISP:WIND:ACT", True

Related Commands

[:DISP:WIND:SPL](#)

[:CALC:PAR:SEL](#)

Equivalent Softkey

Channel Prev, Channel Next

COM Command Syntax (Internal Control Only)

SCPI.DISPLAY.WINDOW(Ch).ACTIVATE

:DISP:WIND<Ch>:ANN:MARK:ALIG

Type

Command/Query

Syntax

:DISPlay:WINDow<Ch>:ANNotation:MARKer:ALIGn[:STATe]
{ON|OFF|1|0}

:DISPlay:WINDow<Ch>:ANNotation:MARKer:ALIGn[:STATe]?

Description

This command turns ON/OFF mode that align the marker display position of each trace based on trace 1.

Variable

Parameter	Selection Option
Description	State of alignment
Data Type	Boolean type (Boolean)
Range	ON OFF 1 0
Preset Value	ON

Query Response

{1|0} <newline> <^END>

Examples

```
Dim Var as Integer
Ana.WriteString ":DISP:WIND1:ANN:MARK:ALIG ON", True
Ana.WriteString ":DISP:WIND1:ANN:MARK:ALIG?", True
Var=Ana.ReadNumber
```

Related Commands

[:DISP:WIND:TRAC:ANN:MARK:POS:X](#)

[:DISP:WIND:TRAC:ANN:MARK:POS:Y](#)

Equivalent Softkey

Marker Fctn > Annotation Options > Align

COM Command Syntax (Internal Control Only)

SCPI.DISPLAY.WINDOW(Ch).ANNOTATION.MARKER.ALIGN.STATE

:DISP:WIND<Ch>:ANN:MARK:SING

Type

Command/Query

Syntax

:DISPlay:WINDow<Ch>:ANNotation:MARKer:SINGle[:STATe]
{ON|OFF|1|0}

:DISPlay:WINDow<Ch>:ANNotation:MARKer:SINGle[:STATe]?

Description

This command turns ON/OFF the display of the marker value of only active traces.

If the function is turned OFF, marker values of all traces (markers) are displayed.

Variable

Parameter	Selection Option
Description	State of marker value display mode
Data Type	Boolean type (Boolean)
Range	ON OFF 1 0
Preset Value	ON

Query Response

{1|0} <newline> <^END>

Examples

```
Dim Var as Integer
Ana.WriteString ":DISP:WIND1:ANN:MARK:SING ON", True
Ana.WriteString ":DISP:WIND1:ANN:MARK:SING?", True
Var=Aa.ReadNumber
```

Related Commands

[:DISP:WIND:ANN:MARK:ALIG](#)

Equivalent Softkey

Marker Fctn > Annotation Options > Active Only

E4990A Impedance Analyzer Help

COM Command Syntax (Internal Control Only)

SCPI.DISPLAY.WINDOW(Ch).ANNOTATION.MARKER.SINGLE.STATE

:DISP:WIND<Ch>:LAB

Type

Command/Query

Syntax

:DISPlay:WINDow<Ch>:LABel {ON|OFF|1|0}

:DISPlay:WINDow<Ch>:LABel?

Description

This command shows/hides the graticule label display of the graph.

Variable

Parameter	Selection Option
Description	ON/OFF of the graticule label display of the graph
Data Type	Boolean type (Boolean)
Range	ON OFF 1 0
Preset Value	ON

Query Response

{1|0} <newline> < ^END>

Examples

```
Dim Var as Integer
Ana.WriteString ":DISP:WIND1:LAB ON", True
Ana.WriteString ":DISP:WIND1:LAB?", True
Var=Ana.ReadNumber
```

Equivalent Softkey

Display > Graticule Label

COM Command Syntax (Internal Control Only)

SCPI.DISPLAY.WINDOW(Ch).LABEL

:DISP:WIND<Ch>:MAX

Type

Command/Query

Syntax

:DISPlay:WINDow<Ch>:MAXimize {ON|OFF|1|0}

:DISPlay:WINDow<Ch>:MAXimize?

Description

This command turns ON/OFF the maximization of the active trace.

Only the maximized active trace is displayed in the window and the other traces are not displayed.

Variable

Parameter	Selection Option
Description	ON/OFF of the maximization of the active trace
Data Type	Boolean type (Boolean)
Range	ON OFF 1 0
Preset Value	OFF

Query Response

{1|0} <newline> <^END>

Examples

```
Dim Var as Integer
Ana.WriteString ":DISP:WIND1:MAX ON", True
Ana.WriteString ":DISP:WIND1:MAX?", True
Var=Ana.ReadNumber
```

Related Commands

[:DISP:MAX](#)

Equivalent Softkey

Trace Max

COM Command Syntax (Internal Control Only)

SCPI.DISPLAY.WINDOW(Ch).MAXIMIZE

:DISP:WIND<Ch>:SPL

Type

Command/Query

Syntax

```
:DISPlay:WINDow<Ch>:SPLit
{D1|D1_2|D12|D1_2_3|D12_34|D1_1_2|D112|D12_33|D13_23|D123|D1
1_23|D12_13|D1234|D1_2_3_4}
```

E4990A Impedance Analyzer Help

:DISPlay:WINDow<Ch>:SPLit?

Description

This command split the traces of the channel display layout on the LCD display.

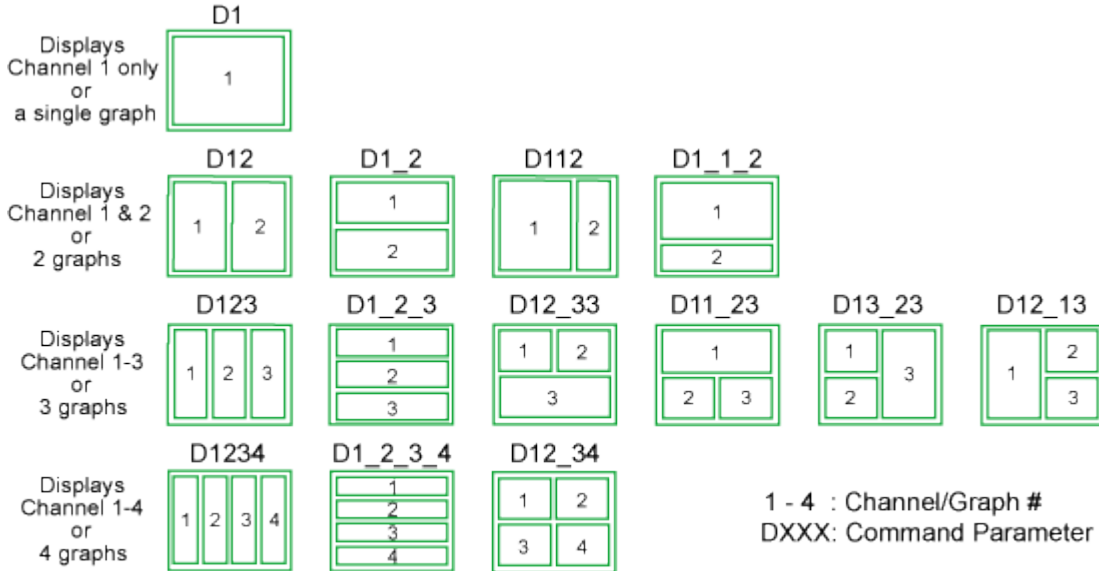

e5061b027

Variable

Parameter	Selection Option
Description	Display layout
Data Type	Character string type (String)
Range	D1 D1_2 D12 D1_2_3 D12_34 D1_1_2 D112 D12_33 D13_23 D123 D1_1_23 D12_13 D1234 D1_2_3_4
Preset Value	D1

Query Response

```
{D1|D1_2|D12|D1_2_3|D12_34|D1_1_2|D112|D12_33|D13_23|D123|D1_1_23|D12_13|D1234|D1_2_3_4}<newline><^END>
```

Examples

```
Dim Var as String
Var= "D1"
Ana.WriteString ":DISP:WIND1:SPL " & Var, True
```

```
Ana.WriteString ":DISP:WIND1:SPL?", True
Var=Ana.ReadString
```

Related Commands

[:DISP:SPL](#)

Equivalent Softkey

Display > **Allocate Traces** > **{Display Layout}**

COM Command Syntax (Internal Control Only)

```
SCPI.DISPLAY.WINDOW(Ch).SPLIT
```

:DISP:WIND<Ch>:TITL

Type

Command/Query

Syntax

```
:DISPlay:WINDow<Ch>:TITLe[:STATe] {ON|OFF|1|0}
```

```
:DISPlay:WINDow<Ch>:TITLe[:STATe]?
```

Description

This command shows/hides the title label display in the title area.

Variable

Parameter	Selection Option
Description	ON/OFF of the title label display
Data Type	Boolean type (Boolean)
Range	ON OFF 1 0
Preset Value	OFF

Query Response

```
{1|0} <newline> < ^END>
```

Examples

```
Dim Var as String
Var = "MyTitle"
Ana.WriteString ":DISP:WIND1:TITL ON", True
Ana.WriteString ":DISP:WIND1:TITL:DATA " & Var, True
Ana.WriteString ":DISP:WIND1:TITL:DATA?", True
Var=Ana.ReadString
```

Related Commands

[:DISP:WIND:TITL:DATA](#)

E4990A Impedance Analyzer Help

Equivalent Softkey

Display > **Title Label**

COM Command Syntax (Internal Control Only)

SCPI.DISPLAY.WINDOW(Ch).TITLE.STATE

:DISP:WIND<Ch>:TITL:DATA

Type

Command/Query

Syntax

:DISPlay:WINDow<Ch>:TITLe:DATA <String>

:DISPlay:WINDow<Ch>:TITLe:DATA?

Description

This command sets/gets the title label displayed in the title area.

Variable

Parameter	String
Description	Title label
Data Type	Character string type (String)
Range	254 chars
Preset Value	""

Query Response

{String} <newline> < ^END>

Examples

See [:DISP:WIND:TITL](#)

Related Commands

[:DISP:WIND:TITL](#)

Equivalent Softkey

Display > **Edit Title Label**

COM Command Syntax (Internal Control Only)

SCPI.DISPLAY.WINDOW(Ch).TITLE.DATA

:DISP:WIND<Ch>:TRAC<Tr>:ACC

Type

Command/Query

Syntax

```
:DISPlay:WINDow<Ch>:TRACe<Tr>:ACCumulate[:STATe] {ON|OFF|1|0}
```

```
:DISPlay:WINDow<Ch>:TRACe<Tr>:ACCumulate[:STATe]?
```

Description

This command turn on/off the trace accumulate mode. The traces are not erased at each sweep and they are overwritten at each sweep.

Variable

Parameter	Selection Option
Description	Status of accumulate mode
Data Type	Boolean type (Boolean)
Range	ON OFF 1 0
Preset Value	OFF

Query Response

```
{1|0}<newline><^END>
```

Examples

```
Dim Var as Integer
Ana.WriteString ":DISP:WIND1:TRAC1:ACC ON", True
Ana.WriteString ":DISP:WIND1:TRAC1:ACC?", True
Var=Ana.ReadNumber
```

Equivalent Softkey

System > **Service Menu** > **Accumulate**

COM Command Syntax (Internal Control Only)

```
SCPI.DISPLAY.WINDOW(Ch).TRACE(Tr).ACCUMULATE.STATE
```

```
:DISP:WIND<Ch>:TRAC<Tr>:ANN:MARK:POS:X
```

Type

Command/Query

Syntax

```
:DISPlay:WINDow<Ch>:TRACe<Tr>:ANNotation:MARKer:POSition:X
<Value>
```

```
:DISPlay:WINDow<Ch>:TRACe<Tr>:ANNotation:MARKer:POSition:X?
```

Description

E4990A Impedance Analyzer Help

This command sets/gets the display position of the marker value on the X-axis by a percentage of a width of the display span.

Variable

Parameter	Value
Description	Display position of the marker value on the X-axis
Data Type	Numeric type (Integer)
Range	-15 to 100
Preset Value	1
Unit	%

Query Response

```
{ numeric } <newline> < ^END >
```

Examples

```
Dim Var as Long
Var= -15
Ana.WriteString ":DISP:WIND1:TRAC1:ANN:MARK:POS:X " & Str(Var), True
Ana.WriteString ":DISP:WIND1:TRAC1:ANN:MARK:POS:X?", True
Var=Ana.ReadNumber
```

Related Commands

[:DISP:WIND:TRAC:ANN:MARK:POS:Y](#)

Equivalent Softkey

Marker Fctn > **Annotation Options** > **Marker Info X Pos**

COM Command Syntax (Internal Control Only)

```
SCPI.DISPLAY.WINDOW(Ch).TRACE(Tr).ANNOTATION.MARKER.POSITION.
X
```

:DISP:WIND<Ch>:TRAC<Tr>:ANN:MARK:POS:Y

Type

Command/Query

Syntax

```
:DISPlay:WINDow<Ch>:TRACe<Tr>:ANNotation:MARKer:POSition:Y
<Value>
```

```
:DISPlay:WINDow<Ch>:TRACe<Tr>:ANNotation:MARKer:POSition:Y?
```

Description

This command sets/gets the display position of the marker value on Y axis by a percentage of a height of the display span.

Variable

Parameter	Value
Description	Display position of the marker value on the Y-axis
Data Type	Numeric type (Integer)
Range	-15 to 100
Preset Value	1
Unit	%

Query Response

```
{ numeric } <newline> < ^END >
```

Examples

```
Dim Var as Long
Var= -15
Ana.WriteString ":DISP:WIND1:TRAC1:ANN:MARK:POS:Y " & Str(Var), True
Ana.WriteString ":DISP:WIND1:TRAC1:ANN:MARK:POS:Y?", True
Var=Ana.ReadNumber
```

Related Commands

[:DISP:WIND:TRAC:ANN:MARK:POS:X](#)

Equivalent Softkey

Marker Fctn > **Annotation Options** > **Marker Info Y Pos**

COM Command Syntax (Internal Control Only)

```
SCPI.DISPLAY.WINDOW(Ch).TRACE(Tr).ANNOTATION.MARKER.POSITION.
Y
```

```
:DISP:WIND<Ch>:TRAC<Tr>:ANN:YAX:MODE
```

Type

Command/Query

Syntax

```
:DISPlay:WINDow<Ch>: TRACe<Tr>: ANNotation: YAXis: MODE
{ AUTO|RELative}
```

```
:DISPlay:WINDow<Ch>: TRACe<Tr>: ANNotation: YAXis: MODE?
```

Description

E4990A Impedance Analyzer Help

This command sets mode for the Y-axis labels.

Variable

Parameter	Selection Option
Description	Y-axis labels mode
Data Type	Character string type (String)
Range	AUTO RELative
Preset Value	AUTO

Query Response

```
{AUTO|REL} <newline> < ^END >
```

Examples

```
Dim Var as String
Var= "AUTO"
Ana.WriteString ":DISP:WIND1:TRAC1:ANN:YAX:MODE " & Var, True
Ana.WriteString ":DISP:WIND1:TRAC1:ANN:YAX:MODE?", True
Var=Ana.ReadString
```

Related Commands

[:DISP:WIND:TRAC:ANN:MARK:POS:Y](#)

Equivalent Softkey

No equivalent key is available on the front panel.

COM Command Syntax (Internal Control Only)

```
SCPI.DISPLAY.WINDOW(Ch).TRACE(Tr).ANNOTATION.YAXIS.MODE
```

:DISP:WIND<Ch>:TRAC<Tr>:MEM

Type

Command/Query

Syntax

```
:DISPlay:WINDow<Ch>:TRACe<Tr>:MEMory[:STATe] {ON|OFF|1|0}
```

```
:DISPlay:WINDow<Ch>:TRACe<Tr>:MEMory[:STATe]?
```

Description

This command shows/hides the memory trace display.

Variable

Parameter	Selection Option
------------------	------------------

Description	ON/OFF of the memory trace display
Data Type	Boolean type (Boolean)
Range	ON OFF 1 0
Preset Value	OFF

Query Response

{1|0} <newline> < ^END>

Examples

```
Dim Var as Integer
Ana.WriteString ":DISP:WIND1:TRAC1:MEM ON", True
Ana.WriteString ":DISP:WIND1:TRAC1:MEM?", True
Var=Ana.ReadNumber
```

Related Commands

[:CALC:MATH:MEM](#)

[:DISP:WIND:TRAC:STAT](#)

Equivalent Softkey

Display > **Display** > **Mem** | **Data & Mem** | **OFF**

COM Command Syntax (Internal Control Only)

SCPI.DISPLAY.WINDOW(Ch).TRACE(Tr).MEMORY.STATE

:DISP:WIND<Ch>:TRAC<Tr>:STAT

Type

Command/Query

Syntax

:DISPlay:WINDow<Ch>:TRACe<Tr>:STATe {ON|OFF|1|0}

:DISPlay:WINDow<Ch>:TRACe<Tr>:STATe?

Description

This command turns ON/OFF the data trace display.

Variable

Parameter	Selection Option
Description	ON/OFF of the data trace display

E4990A Impedance Analyzer Help

Data Type	Boolean type (Boolean)
Range	ON OFF 1 0
Preset Value	ON

Query Response

{1|0} <newline> <^END>

Examples

```
Dim Var as Integer
Ana.WriteString ":DISP:WIND1:TRAC1:STAT ON", True
Ana.WriteString ":DISP:WIND1:TRAC1:STAT?", True
Var=Ana.ReadNumber
```

Related Commands

[:DISP:WIND:TRAC:MEM](#)

Equivalent Softkey

Display > **Display** > **Data** | **Data & Mem** | **OFF**

COM Command Syntax (Internal Control Only)

SCPI.DISPLAY.WINDOW(Ch).TRACE(Tr).STATE

:DISP:WIND<Ch>:TRAC<Tr>:X:RLEV

Type

Command/Query

Syntax

:DISPlay:WINDow<Ch>:TRACe<Tr>:X[:SCALe]:RLEVel <Value>

:DISPlay:WINDow<Ch>:TRACe<Tr>:X[:SCALe]:RLEVel?

Description

This command sets/gets the value of the reference division line for X-axis.

Variable

Parameter	Value
Description	Value of reference division line
Data Type	Numeric type (Real)
Range	-500M to 500M

Preset Value	0
Unit	Depends on measurement format

Query Response

{ numeric } <newline> < ^END >

Examples

```
Dim Var as Double
Var= -10
Ana.WriteString ":DISP:WIND1:TRAC1:X:RLEV " & Str(Var), True
Ana.WriteString ":DISP:WIND1:TRAC1:X:RLEV?", True
Var=Ana.ReadNumber
```

Related Commands

[:FORM:DATA](#)

Equivalent Softkey

Scale > Reference X Value

COM Command Syntax (Internal Control Only)

SCPI.DISPLAY.WINDOW(Ch).TRACE(Tr).X.SCALE.RLEVEL

:DISP:WIND<Ch>:TRAC<Tr>:Y:AUTO

Type

Command

Syntax

:DISPlay:WINDow<Ch>:TRACe<Tr>:Y[:SCALE]:AUTO

Description

This command executes the auto scale function. The Auto Scale function automatically adjusts the value of the reference division line and the scale per division to display the trace appropriately.

Examples

```
Ana.WriteString ":DISP:WIND:TRAC:Y:AUTO", True
```

Related Commands

[:DISP:WIND:TRAC:Y:PDIV](#)

[:DISP:WIND:TRAC:Y:RLEV](#)

Equivalent Softkey

Scale > Auto Scale

COM Command Syntax (Internal Control Only)

SCPI.DISPLAY.WINDOW(Ch).TRACE(Tr).Y.SCALE.AUTO

:DISP:WIND<Ch>:TRAC<Tr>:Y:BOTT

Type

E4990A Impedance Analyzer Help

Command/Query

Syntax

:DISPlay:WINDow<Ch>:TRACe<Tr>:Y[:SCALE]:BOTTom <Value>

:DISPlay:WINDow<Ch>:TRACe<Tr>:Y[:SCALE]:BOTTom?

Description

This command sets the minimum scale value for the Log Y-axis.

Variable

Parameter	Value
Description	Minimum scale value
Data Type	Numeric type (Real)
Range	1a to 500P
Preset Value	1m
Unit	Depends on Measurement Format

Query Response

{ numeric } <newline> < ^END >

Examples

```
Dim Var as Double
Var=10
Ana.WriteString ":DISP:WIND1:TRAC1:Y:BOTT" & Str(Var), True
Ana.WriteString ":DISP:WIND1:TRAC1:Y:BOTT?", True
Var=Ana.ReadNumber
```

Related Commands

[:DISP:WIND:TRAC:Y:TOP](#)

Equivalent Softkey

Scale > **Log Y-Axis Top/Bottom** > **Bottom Value**

COM Command Syntax (Internal Control Only)

SCPI.DISPLAY.WINDOW(Ch).TRACE(Tr).Y.SCALE.BOTTOM

:DISP:WIND<Ch>:TRAC<Tr>:Y:PDIV

Type

Command/Query

Syntax

:DISPlay:WINDow<Ch>:TRACe<Tr>:Y[:SCALe]:PDIVision <Value>

:DISPlay:WINDow<Ch>:TRACe<Tr>:Y[:SCALe]:PDIVision?

Description

This command sets the scale per division for the data format.

Variable

Parameter	Value
Description	Scale value
Data Type	Numeric type (Real)
Range	1a to 100M
Preset Value	10
Unit	Depends on Measurement Format

Query Response

{numeric} <newline> < ^END >

Examples

```
Dim Var as Double
Var= 0.1
Ana.WriteString ":DISP:WIND1:TRAC1:Y:PDIV " & Str(Var), True
Ana.WriteString ":DISP:WIND1:TRAC1:Y:PDIV?", True
Var=Ana.ReadNumber
```

Related Commands

[:FORM:DATA](#)

[:DISP:WIND:TRAC:Y:AUTO](#)

[:DISP:WIND:TRAC:Y:RLEV](#)

[:DISP:WIND:TRAC:Y:RPOS](#)

Equivalent Softkey

Scale > **Scale/Div**

COM Command Syntax (Internal Control Only)

SCPI.DISPLAY.WINDOW(Ch).TRACE(Tr).Y.SCALE.PDIVISION

:DISP:WIND<Ch>:TRAC<Tr>:Y:RLEV

Type

E4990A Impedance Analyzer Help

Command/Query

Syntax

:DISPlay:WINDow<Ch>:TRACe<Tr>:Y[:SCALe]:RLEVel <Value>

:DISPlay:WINDow<Ch>:TRACe<Tr>:Y[:SCALe]:RLEVel?

Description

This command sets/gets the value of the reference division line for y-axis.

Variable

Parameter	Value
Description	Value of reference division line
Data Type	Numeric type (Real)
Range	-500M to 500M
Preset Value	0
Unit	Depends on Measurement Format

Query Response

{ numeric } <newline> < ^END >

Examples

```
Dim Var as Double
Var= -10
Ana.WriteString ":DISP:WIND1:TRAC1:Y:RLEV " & Str(Var), True
Ana.WriteString ":DISP:WIND1:TRAC1:Y:RLEV?", True
Var=Ana.ReadNumber
```

Related Commands

[:FORM:DATA](#)

[:DISP:WIND:TRAC:Y:PDIV](#)

[:DISP:WIND:TRAC:Y:RPOS](#)

Equivalent Softkey

Scale > Reference Y Value

COM Command Syntax (Internal Control Only)

SCPI.DISPLAY.WINDOW(Ch).TRACE(Tr).Y.SCALE.RLEVEL

:DISP:WIND<Ch>:TRAC<Tr>:Y:RPOS

Type

Command/Query

Syntax

```
:DISPlay:WINDow<Ch>:TRACe<Tr>:Y[:SCALe]:RPOSition <Value>
```

```
:DISPlay:WINDow<Ch>:TRACe<Tr>:Y[:SCALe]:RPOSition?
```

Description

This command specifies the position of a reference division line with its number (an integer assigned starting from 0 from the lowest division).

Variable

Parameter	Value
Description	Position of reference division line
Data Type	Numeric type (Integer)
Range	0 to 30
Preset Value	5
Unit	Div
Resolution	1

Query Response

```
{ numeric } <newline> < ^END >
```

Examples

```
Dim Var as Long
Var= 8
Ana.WriteString ":DISP:WIND1:TRAC1:Y:RPOS " & Str(Var), True
Ana.WriteString ":DISP:WIND1:TRAC1:Y:RPOS?", True
Var=Ana.ReadNumber
```

Related Commands

[:DISP:WIND:TRAC:Y:RLEV](#)

[:DISP:WIND:TRAC:Y:PDIV](#)

Equivalent Softkey

Scale > Reference Position

COM Command Syntax (Internal Control Only)

```
SCPI.DISPLAY.WINDOW(Ch).TRACE(Tr).Y.SCALE.RPOSITION
```

:DISP:WIND<Ch>:TRAC<Tr>:Y:TOP

Type

Command/Query

Syntax

:DISPlay:WINDow<Ch>:TRACe<Tr>:Y[:SCALe]:TOP <Value>

:DISPlay:WINDow<Ch>:TRACe<Tr>:Y[:SCALe]:TOP?

Description

This command sets the maximum scale value for the Log Y-axis.

Variable

Parameter	Value
Description	Maximum scale value
Data Type	Numeric type (Real)
Range	2a to 1E
Preset Value	1k
Unit	Depends on Measurement Format

Query Response

{ numeric } <newline> < ^END >

Examples

```
Dim Var as Double
Var= 1000
Ana.WriteString ":DISP:WIND1:TRAC1:Y:TOP" & Str(Var), True
Ana.WriteString ":DISP:WIND1:TRAC1:Y:TOP?", True
Var=Ana.ReadNumber
```

Related Commands

[:DISP:WIND:TRAC:Y:BOTT](#)

Equivalent Softkey

Scale > Log Y-Axis Top/Bottom > Top Value

COM Command Syntax (Internal Control Only)

SCPI.DISPLAY.WINDOW(Ch).TRACE(Tr).Y.SCALE.TOP

:DISP:WIND<Ch>:TRAC<Tr>:Y:SPAC

Type

Command/Query

Syntax

```
:DISPlay:WINDow<Ch>:TRACe<Tr>:Y:SPACing {LINear|LOGarithmic}
:DISPlay:WINDow<Ch>:TRACe<Tr>:Y:SPACing?
```

Description

This command sets the display type of the graph vertical axis (Y-axis).

Variable

Parameter	Selection Option
Description	Vertical axis display type of the graph
Data Type	Character string type (String)
Range	LINear LOGarithmic
Preset Value	LINear

Query Response

```
{LIN|LOG} <newline> < ^END>
```

Examples

```
Dim Var as String
Var= "LIN"
Ana.WriteString ":DISP:WIND1:TRAC1:Y:SPAC" & Var, True
Ana.WriteString ":DISP:WIND1:TRAC1:Y:SPAC?", True
Var=Ana.ReadString
```

Related Commands

[:SENS:SWE:TYPE](#)

Equivalent Softkey

Format > Y-Axis

Instr Setup > Y-Axis

COM Command Syntax (Internal Control Only)

```
SCPI.DISPLAY.WINDOW(Ch).TRACE(Tr).Y.SPACING
```

:DISP:WIND<Ch>:TRAC<Tr>:Y:TRAC:FREQ

Type

Command/Query

Syntax

E4990A Impedance Analyzer Help

:DISPlay:WINDow<Ch>:TRACe<Tr>:Y:TRACk:FREQuency <Value>

:DISPlay:WINDow<Ch>:TRACe<Tr>:Y:TRACk:FREQuency?

Description

This command selects frequency to track with reference tracking.

Variable

Parameter	Value
Description	Frequency reference tracking
Data Type	Numeric type (Real)
Range	-1T to 1T
Preset Value	0
Unit	Hz V A

Query Response

{ numeric } <newline> < ^END >

Examples

Dim Var as Double

Var=1000

Ana.WriteString ":DISP:WIND1:TRAC1:Y:TRAC:FREQ" & Var, True

Ana.WriteString ":DISP:WIND1:TRAC1:Y:TRAC:FREQ?", True

Var=Ana.ReadString

Related Commands

[:DISP:WIND:TRAC:Y:TRAC:MODE](#)

Equivalent Softkey

Scale > Reference Tracking > Tracking Frequency

COM Command Syntax (Internal Control Only)

SCPI.DISPLAY.WINDOW(Ch).TRACE(Tr).Y.TRACK.FREQUENCY

:DISP:WIND<Ch>:TRAC<Tr>:Y:TRAC:MODE

Type

Command/Query

Syntax

:DISPlay:WINDow<Ch>:TRACe<Tr>:Y:TRACk:MODE
{ OFF|PEAK|FREQuency }

:DISPlay:WINDow<Ch>:TRACe<Tr>:Y:TRACk:MODE?

Description

This command selects reference offset tracking method.

Variable

Parameter	Selection Option
Description	Reference offset tracking
Data Type	Character string type (String)
Range	OFF PEAK FREQuency
Preset Value	OFF

Query Response

{ OFF|PEAK|FREQ} <newline> < ^END >

Examples

```
Dim Var as String
Var= "peak"
Ana.WriteString ":DISP:WIND1:TRAC1:Y:TRAC:MODE" & Var, True
Ana.WriteString ":DISP:WIND1:TRAC1:Y:TRAC:MODE?", True
Var=Ana.ReadString
```

Related Commands

[:DISP:WIND:TRAC:Y:TRAC:FREQ](#)

Equivalent Softkey

Scale > **Reference Tracking** > **Tracking** > **OFF|Track Peak|Track Freq**

COM Command Syntax (Internal Control Only)

SCPI.DISPLAY.WINDOW(Ch).TRACE(Tr).Y.TRACK.MODE

:DISP:WIND<Ch>:X:SPAC

Type

Command/Query

Syntax

:DISPlay:WINDow<Ch>:X:SPACing {LINear|OBASe}

:DISPlay:WINDow<Ch>:X:SPACing?

Description

E4990A Impedance Analyzer Help

This command selects the display type of the graph horizontal axis (x-axis) for segment sweep.

Variable

Parameter	Selection Option
Description	Horizontal axis display type of the graph for segment sweep
Data Type	Character string type (String)
Range	LINear: Frequency Base OBASe: Order Base
Preset Value	OBASe

Query Response

```
{LIN|OBAS} <newline> < ^END>
```

Examples

```
Dim Var as String  
Var= "LINear"  
Ana.WriteString ":DISP:WIND1:X:SPAC" & Var, True  
Ana.WriteString ":DISP:WIND1:X:SPAC?", True  
Var=Ana.ReadString
```

Related Commands

[:SENS:SWE:TYPE](#)

Equivalent Softkey

Sweep Setup > **Segment Display**

COM Command Syntax (Internal Control Only)

```
SCPI.DISPLAY.WINDOW(Ch).X.SPACING
```

:DISP:WIND<Ch>:Y:DIV

Type

Command/Query

Syntax

```
:DISPlay:WINDow<Ch>:Y[:SCALE]:DIVisions <Value>
```

```
:DISPlay:WINDow<Ch>:Y[:SCALE]:DIVisions?
```

Description

This command sets/gets the number of divisions in all the graphs.

Variable

Parameter	Value
Description	Number of divisions of graph
Data Type	Numeric type (Integer)
Range	4 to 30
Preset Value	10
Resolution	2

Query Response

```
{ numeric} <newline> < ^END>
```

Examples

```
Dim Var as Long
Var= 20
Ana.WriteString ":DISP:WIND1:Y:DIV " & Str(Var), True
Ana.WriteString ":DISP:WIND1:Y:DIV?", True
Var=Ana.ReadNumber
```

Related Commands

[:DISP:WIND:TRAC:Y:PDIV](#)

[:DISP:WIND:TRAC:Y:RLEV](#)

[:DISP:WIND:TRAC:Y:RPOS](#)

Equivalent Softkey

Scale > Divisions

COM Command Syntax (Internal Control Only)

```
SCPI.DISPLAY.WINDOW(Ch).Y.SCALE.DIVISIONS
```

FORM

:FORM:BORD

Type

Command/Query

Syntax

E4990A Impedance Analyzer Help

:FORMat:BORDER {NORMal|SWAPped}

:FORMat:BORDER?

Description

This command sets/gets the byte order setting for binary transfer.

Variable

Parameter	Selection Option
Description	Byte order setting
Data Type	Character string type (String)
Range	NORMal SWAPped
Preset Value	NORMal

Query Response

{ NORM|SWAP } <newline> < ^END >

Examples

```
Dim Var as String
Var= "NORM"
Ana.WriteString ":FORM:BORD " & Var, True
Ana.WriteString ":FORM:BORD?", True
Var=Ana.ReadString
```

Related Commands

[:FORM:DATA](#)

Equivalent Softkey

No equivalent key is available on the front panel.

COM Command Syntax (Internal Control Only)

SCPI.FORMAT.BORDER

:FORM:DATA

Type

Command/Query

Syntax

:FORMat:DATA {ASCii|REAL|REAL32}

:FORMat:DATA?

Description

This command can be used to set/get the format data using the following SCPI commands:

[:CALC:DATA:FDAT](#)

[:CALC:DATA:FMEM](#)

[:CALC:DATA:RDAT](#)

[:CALC:DATA:RMEM](#)

[:CALC:DATA:XAX](#)

[:CALC:FUNC:DATA](#)

[:CALC:LIM:DATA](#)

[:CALC:LIM:REP](#)

[:CALC:LIM:REP:ALL](#)

[:SENS:FREQ:DATA](#)

[:SENS:SEGM:DATA](#)

Variable

Parameter	Selection Option
Description	Data transfer mode
Data Type	Character string type (String)
Range	ASCII: ASCII transfer format REAL: IEEE 64-bit floating point binary transfer format REAL32: IEEE 32-bit floating point binary transfer format
Preset Value	ASCII

Query Response

{ASC|REAL|REAL32} <newline> < ^END>

Examples

```
Dim Var as String
Var= "ASC"
Ana.WriteString ":FORM:DATA " & Var, True
Ana.WriteString ":FORM:DATA?", True
Var=Ana.ReadString
```

Related Commands

E4990A Impedance Analyzer Help

[:FORM:REAL:ASC:LENG](#)

Equivalent Softkey

No equivalent key is available on the front panel.

COM Command Syntax (Internal Control Only)

SCPI.FORMAT.DATA

:FORM:REAL:ASC:LENG

Type

Command/Query

Syntax

:FORMat:REAL:ASCii:LENGth <Value>

:FORMat:REAL:ASCii:LENGth?

Description

This command sets/gets the number of significant digits of a floating point number value to be returned as ascii bytes in format.

Variable

Parameter	Value
Description	Number of significant digits
Data Type	Numeric type (Integer)
Range	12 14
Preset Value	12

Query Response

{numeric} <newline> < ^END>

Examples

```
Dim Var as Long
Ana.WriteString ":FORM:REAL:ASC:LENG 12", True
Ana.WriteString ":FORM:REAL:ASC:LENG?", True
Var=Ana.ReadNumber
```

Related Commands

[:FORM:DATA](#)

Equivalent Softkey

No equivalent key is available on the front panel.

COM Command Syntax (Internal Control Only)

SCPI.FORMAT.REAL.ASCII.LENGTH

HCOPY**:HCOP**

Type

Command

Syntax

:HCOPY[:IMMEDIATE]

Description

This command is print screen image. This function outputs the display image on the LCD display to the printer with connected to the E4990A.

Examples

```
Ana.WriteString ":HCOP", True
```

Related Commands

[:HCOP:ABOR](#)

[:HCOP:IMAG](#)

Equivalent Softkey

System > Print

COM Command Syntax (Internal Control Only)

```
SCPI.HCOPY.IMMEDIATE
```

:HCOP:ABOR

Type

Command

Syntax

:HCOPY:ABORT

Description

This command aborts the print output.

Examples

```
Ana.WriteString ":HCOP:ABOR", True
```

Related Commands

[:HCOP](#)

Equivalent Softkey

No equivalent key is available on the front panel.

NOTE

Printer output can be aborted from Windows Printer Dialog box.
Windows Start > Device and Printers > {installed Printer}
In menu of the printer dialog box, Documentation > Cancel

COM Command Syntax (Internal Control Only)

```
SCPI.HCOPY.ABORT
```

E4990A Impedance Analyzer Help

:HCOP:IMAG

Type

Command/Query

Syntax

:HCOPY:IMAGe {NORMal|INVert}

:HCOPY:IMAGe?

Description

This command selects the print image color (to the printer).

Variable

Parameter	Selection Option
Description	Print color for output to the printer
Data Type	Character string type (String)
Range	NORMal: Normal color INVert: Invert color
Preset Value	INVert

Query Response

{NORM|INV} <newline> <^END>

Examples

```
Dim Var as String
Var= "NORMal"
Ana.WriteString ":HCOP:IMAG" & Var, True
Ana.WriteString ":HCOP:IMAG?", True
Var=Ana.ReadString
```

Related Commands

[:HCOP](#)

Equivalent Softkey

System > Invert Image

COM Command Syntax (Internal Control Only)

SCPI.HCOPY.IMAGE

:HCOP:SDUM:DATA

Type

Query

Syntax

```
:HCOPYy:SDUMp:DATA[:IMMEDIATE]?
```

Description

This command allows to save the print screen image into an external PC.

Variable**Query Response**

```
{byte} <newline> < ^END>
```

Examples

See [Capturing Screen Into PC](#).

Related Commands

[:HCOP:SDUM:DATA:FORM](#)

Equivalent Softkey

No equivalent key is available on the front panel.

COM Command Syntax (Internal Control Only)

```
SCPI.HCOPY.SDUMP.DATA.IMMEDIATE
```

:HCOP:SDUM:DATA:FORM**Type**

Command/Query

Syntax

```
:HCOPYy:SDUMp:DATA:FORMat {PNG|BMP}
```

```
:HCOPYy:SDUMp:DATA:FORMat?
```

Description

This command selects the image format of screen capture.

Variable

Parameter	Selection Option
Description	Image format
Data Type	Character string type (String)
Range	PNG: Portable network graphics BMP: bitmap image
Preset Value	PNG

Query Response

E4990A Impedance Analyzer Help

{PNG|BMP} <newline> < ^END >

Examples

See [Capturing Screen Into PC](#).

Related Commands

[:HCOP:SDUM:DATA](#)

Equivalent Softkey

No equivalent key is available on the front panel.

COM Command Syntax (Internal Control Only)

SCPI.HCOPY.SDUMP.DATA.FORMAT

IEEE

*CLS

Type

Command

Syntax

*CLS

Description

This command clears the following:

- Error Queue
- Status Byte Register
- Standard Event Status Register
- Operation Status Event Register
- Questionable Status Event Register
- Questionable Limit Status Event Register
- Questionable Limit Channel Status Event Register

Examples

Ana.WriteString "*CLS", True

Related Commands

[*STB](#)

Equivalent Softkey

No equivalent key is available on the front panel.

COM Command Syntax (Internal Control Only)

SCPI.IEEE4882.CLS

*ESE

Type

Command/Query

Syntax

*ESE <Value>

*ESE?

Description

This command sets/gets the value of the Standard Event Status Enable Register.

Variable

Parameter	Value
Description	Value of the Standard Event Status Enable Register
Data Type	Numeric type (Integer)
Preset Value	0

Query Response

{ numeric } <newline> < ^END >

Examples

```
Dim Var as Long
Ana.WriteString "*ESE" & Var, True
Ana.WriteString "*ESE?", True
Var=Ana.ReadString
```

Related Commands

[*SRE](#)

See [Status Register](#)

Equivalent Softkey

No equivalent key is available on the front panel.

COM Command Syntax (Internal Control Only)

SCPI.IEEE4882.ESE

***ESR**

Type

Query

Syntax

*ESR?

Description

E4990A Impedance Analyzer Help

This command reads the value of the Standard Event Status Register. Execution of this command clears the register value.

Variable

Parameter	Value
Description	Value of the Standard Event Status Register
Data Type	Numeric type (Integer)
Preset Value	128

Query Response

```
{ numeric } <newline> < ^END >
```

Examples

```
Dim Var as Long  
Ana.WriteString "*ESR?", True  
Var=Ana.ReadString
```

Related Commands

See [Status Register](#)

Equivalent Softkey

No equivalent key is available on the front panel.

COM Command Syntax (Internal Control Only)

```
SCPI.IEEE4882.ESR
```

*IDN

Type

Query

Syntax

```
*IDN?
```

Description

This command reads the product information (manufacturer, model number, serial number, and firmware revision number) of the E4990A.

Variable

Query Response

```
{ string 1 }, { string 2 }, { string 3 }, { string 4 } <newline> < ^END >
```

- { string 1 }: Manufacturer. "Keysight Technologies" is always read out.

- {string 2}: Model number. "E4990A" is always read out.
- {string 3}: Serial number (example: MY123400101).
- {string 4}: Firmware revision number (example: A.01.00).

Examples

```
Dim Var as String
Ana.WriteString "*IDN?", True
Var=Ana.ReadString
```

Related Commands

[*OPT](#)

Equivalent Softkey**System > Firmware Revision****COM Command Syntax (Internal Control Only)**

```
SCPI.IEEE4882.IDN
```

LRN*Type**

Query

Syntax

```
*LRN?
```

Description

This command gets the device setup query. This command is defined as "Learn Device Setup Query" in IEEE 488.2. The command returns instrument settings by binary block data (same as Save/Recall state file contents) with "SYSTEM:SET " prefix.

The returned data is the same as the contents of state file which can be saved by the [:MMEM:STOR](#). Therefore, the returned data contents is changed according to the setting of [:MMEM:STOR:STYP](#).

Variable**Query Response**

```
{binary} <newline> < ^END>
```

Examples

```
Dim LRNData() As Byte, SETData() As Byte, NoofByte As Double
*** Get the LRN data as Binary data
Ana.WriteString "*LRN?", True
LRNData = Ana.ReadIEEEBlock(BinaryType_UI1, False, True)
```

```
*** Save the LRN data in the file
Open "C:\LRN.dat" For Binary As #1
```

E4990A Impedance Analyzer Help

```
Put #1, , LRNData()
```

```
Close
```

```
MsgBox "Get Data"
```

```
*** Recall the LRN data from the file
```

```
Open "C:\LRN.dat" For Binary As #1
```

```
NoofByte = LOF(1)
```

```
ReDim SETData(NoofByte)
```

```
Get #1, , SETData()
```

```
Close
```

```
*** Send the LRN data to E4990A
```

```
Ana.IO.Write SETData, NoofByte
```

Related Commands

[:MMEM:STOR](#)

[:MMEM:STOR:STYP](#)

[:SYST:SET](#)

Equivalent Softkey

No equivalent key is available on the front panel.

COM Command Syntax (Internal Control Only)

```
SCPI.IEEE4882.LRN
```

*OPC

Type

Command/Query

Syntax

```
*OPC
```

```
*OPC?
```

Description

This command sets/gets the operation complete (OPC) bit (bit 0) of the [Standard Event Status Register](#). When all of pending operations complete,

*OPC returns 1.

Variable

Query Response

```
{1} <newline> < ^END>
```

Examples

```
Dim Var as Integer
Ana.WriteString "**OPC?", True
Var=Ana.ReadNumber
```

Related Commands

[*CLS](#)

[*ESE](#)

Equivalent Softkey

No equivalent key is available on the front panel.

COM Command Syntax (Internal Control Only)

SCPI.IEEE4882.OPC

OPT*Type**

Query

Syntax

*OPT?

Description

This command reads the identification numbers of options installed in the E4990A.

Variable**Query Response**

{String} <newline> < ^END>

Option number with "," separator (Example: "010, 120")

Examples

```
Dim Var as String
Ana.WriteString "**OPT?", True
Var=Ana.ReadNumber
```

Related Commands

[*IDN](#)

Equivalent Softkey

System > **Firmware Revision**

COM Command Syntax (Internal Control Only)

SCPI.IEEE4882.OPT

RST*Type**

Command

Syntax

*RST

Description

E4990A Impedance Analyzer Help

This command presets the E4990A to its default settings and is different from setting state preset with the [:SYST:PRES](#) as the continuous initiation mode (see [:INIT:CONT](#)) of channel 1 is set to OFF.

Examples

```
Ana.WriteString "**RST", True
```

Related Commands

[:SYST:PRES](#)

[:SYST:UPR](#)

Equivalent Softkey

No equivalent key is available on the front panel.

COM Command Syntax (Internal Control Only)

```
SCPI.IEEE4882.RST
```

*SRE

Type

Command/Query

Syntax

```
*SRE <Value>
```

```
*SRE?
```

Description

This command sets/gets the value of Service Request Enable Register. Only bit [0-5,7] are used.

Variable

Parameter	Value
Description	Value of the Service Request Enable Register
Data Type	Numeric type (Integer)

Query Response

```
{ numeric } <newline> < ^END >
```

Examples

```
Dim Var as Long  
Ana.WriteString "**SRE " & Var, True  
Ana.WriteString "**SRE?", True  
Var=Ana.ReadString
```

Related Commands

[*ESE](#)

[:STAT:OPER:ENAB](#)

[:STAT:QUES:ENAB](#)

See [Status Register](#)

Equivalent Softkey

No equivalent key is available on the front panel.

COM Command Syntax (Internal Control Only)

SCPI.IEEE4882.SRE

STB*Type**

Query

Syntax

*STB?

Description

This command reads the value of Status Byte Register.

Variable**Query Response**

{ numeric } <newline> < ^END >

Examples

```
Dim Var as Integer
Ana.WriteString "*STB?", True
Var=Ana.ReadNumber
```

Related Commands

See [Status Register](#)

Equivalent Softkey

No equivalent key is available on the front panel.

COM Command Syntax (Internal Control Only)

SCPI.IEEE4882.STB

TRG*Type**

Command

Syntax

*TRG

Description

This command triggers the E4990A if the trigger source is set to Bus.

Examples

```
Ana.WriteString "*TRG", True
```

Related Commands

[:TRIG:SOUR](#)

E4990A Impedance Analyzer Help

[:TRIG:SING](#)

[:TRIG](#)

Equivalent Softkey

No equivalent key is available on the front panel.

COM Command Syntax (Internal Control Only)

SCPI.IEEE4882.TRG

*TST

Type

Query

Syntax

*TST?

Description

This command is self-test query. The self-test is not executed by this command in the case of the E4990A. Always returns 0 for IEEE compliance.

Variable

Query Response

{0} <newline> <^END>

Examples

```
Dim Var as Integer
Ana.WriteString "*TST?", True
Var=Ana.ReadNumber
```

Equivalent Softkey

No equivalent key is available on the front panel.

COM Command Syntax (Internal Control Only)

SCPI.IEEE4882.TST

*WAI

Type

Command

Syntax

*WAI

Description

This command waits for the execution of all objects sent before this command is completed.

Examples

```
Ana.WriteString "*WAI", True
```

Equivalent Softkey

No equivalent key is available on the front panel.

COM Command Syntax (Internal Control Only)

SCPI.IEEE4882.WAI

INIT**:INIT<Ch>****Type**

Command

Syntax

:INITiate<Ch>[:IMMediate]

Description

This command changes the state of each channel to the initiation state in the [trigger system](#).

When this command is executed for a channel in the idle state in the [trigger system](#), it goes into the initiation state immediately. Then, after measurement is executed once, it goes back to the idle state.

If this command is executed for a channel that is not in the idle state or a channel for which the continuous initiation mode is set to ON (setting by which the trigger system initiates continuously) in the [trigger system](#), an error occurs when executed and the object is ignored.

Examples

Ana.WriteString ":INIT", True

Related Commands[:INIT:CONT](#)**Equivalent Softkey****Trigger** > **Single** (When [:INIT:CONT](#) is OFF.)**COM Command Syntax (Internal Control Only)**

SCPI.INITIATE(ch).IMMEDIATE

:INIT<Ch>:CONT**Type**

Command/Query

Syntax

:INITiate<Ch>:CONTinuous {ON|OFF|1|0}

:INITiate<Ch>:CONTinuous?

Description

This command turns ON/OFF the continuous initiation mode (setting by which the trigger system initiates continuously) in the [trigger system](#).

Variable

Parameter	Selection Option

E4990A Impedance Analyzer Help

Description	ON/OFF of the continuous initiation mode
Data Type	Boolean type (Boolean)
Range	ON OFF 1 0
Preset Value	OFF

Query Response

{1|0} <newline> < ^END >

Examples

```
Dim Var as Long
Ana.WriteString ":INIT1:CONT ON", True
Ana.WriteString ":INIT1:CONT?", True
Var=Ana.ReadNumber
```

Related Commands

[:INIT](#)

Equivalent Softkey

Trigger > **Hold** | **Continuous** | **Hold All Channels** (This is not exact equivalent softkey.)

COM Command Syntax (Internal Control Only)

SCPI.INITIATE(Ch).CONTINUOUS

LXI

:LXI:IDEN

Type

Command/Query

Syntax

:LXI:IDENtify[:STATe] {ON|OFF|1|0}

:LXI:IDENtify[:STATe]?

Description

This command sets or gets the LXI Status Indicator state.

Variable

Parameter	Selection Option
Description	ON/OFF LXI Control Identification

Data Type	Boolean type (Boolean)
Range	ON OFF 1 0
Preset Value	OFF

Query Response

```
{1|0} <newline> < ^END >
```

Examples

```
Dim Var as Long
Ana.WriteString ":LXI:IDEN ON", True
Ana.WriteString ":LXI:IDEN?", True
Var=Ana.ReadNumber
```

Equivalent Softkey

No equivalent key is available on the front panel.

COM Command Syntax (Internal Control Only)

```
SCPI.LXI.IDENTIFY.STATE
```

MMEMORY**:MMEM:CAT****Type**

Query

Syntax

```
:MMEMory:CATalog?
```

Description

This command reads the following information on the built-in storage device of the E4990A:

- Space in use
- Available space
- Name and size of all files (including directories) in the specified directory

NOTE

To read out the information in the root directory (folder), specify "\" (backslash). Separate between directory names (file name) with "\" (back slash), or "/" (slash).

Variable

Parameter	Value1
------------------	--------

E4990A Impedance Analyzer Help

Description	Directory name of which the information you want to read out
Data Type	Character string type (String)
Range	254 chars

Query Response

{ Value 2 } <newline> < ^END >

Parameter	Value2
Description	<p>Directory information (" {A} , {B} , {Name 1} , {Size 1} , {Name 2} , {Size 2} , ... , {Name N} , {Size N} ")</p> <p>Where N is the number of all files in the specified directory and n is an integer between 1 and N.</p> <p>{A}: Space in use of the built-in storage device (byte).</p> <p>{B}: Available space of the built-in storage device (byte).</p> <p>{Name n}: Name of the n-th file (directory).</p> <p>{Size n}: Size (byte) of the n-th file (directory). Always 0 for directories.</p>
Data Type	Character string type (String)
Range	254 chars

Examples

```
Dim Var as Variant
Ana.WriteString ":MMEM:CAT? ""D: """, True
Var=Ana.Readlist
```

Equivalent Softkey

No equivalent key is available on the front panel.

COM Command Syntax (Internal Control Only)

```
SCPI.MMEMORY.CATALOG
```

:MMEM:COPY**Type**

Command

Syntax

:MMEMory:COPY <Value1>, <Value2>

Description

This command copies a file.

NOTE

Specify the file name with the extension. When you use directory names (folder names) and file name, separate them with "\" (back slash), or "/" (slash).

Variable

Parameter	Value1
Description	Source file name
Data Type	Character string type (String)
Range	254 chars

Parameter	Value2
Description	Destination file name
Data Type	Character string type (String)
Range	254 chars

Examples

```
Ana.WriteString ":MMEM:COPY ""D:\temp1.txt"", ""D:\temp2.txt"", True
```

Equivalent Softkey

No equivalent key is available on the front panel.

COM Command Syntax (Internal Control Only)

SCPI.MMEMORY.COPY

:MMEM:DEL**Type**

Command

Syntax

:MMEMory:DELete <Value>

Description

This command deletes an existing file or directory (folder).

NOTE When you delete a directory, all the files and directories in it are deleted.

Specify the file name with the extension.

When you specify a file (directory) under an existing directory, separate them with "\" (back slash), or "/" (slash).

To delete all the files in the directory (folder), specify "\" (backslash).

Variable

Parameter	Value
Description	File name or directory name you want to delete
Data Type	Character string type (String)
Range	254 chars

Examples

```
Dim Var as String
Var = "C:\temp\temp.txt"
Ana.WriteString ":MMEM:DEL" & Var, True
```

Equivalent Softkey

No equivalent key is available on the front panel.

COM Command Syntax (Internal Control Only)

SCPI.MMEMORY.DELETE

:MMEM:LOAD

Type

Command

Syntax

:MMEMory:LOAD[:STATe] <Value>

Description

This command recalls the specified instrument state file (file with a .sta extension saved with [:MMEM:STOR](#))

NOTE Specify the file name with the extension. When you use directory names and file name, separate them with "\" (back slash), or "/" (slash).

Variable

Parameter	Value
Description	File name of instrument state (extension ".sta")
Data Type	Character string type (String)
Range	254 chars

Examples

```
Dim Var as String
Var = "D:\state1.sta"
Ana.WriteString ":MMEM:LOAD " & Var, True
```

Related Commands

[:MMEM:STOR](#)

Equivalent Softkey

Save/Recall > **Recall State** > **State01** to **State08**

Save/Recall > **Recall State** > **Autorec**

Save/Recall > **Recall State** > **UserPres**

Save/Recall > **Recall State** > **File Dialog...**

COM Command Syntax (Internal Control Only)

SCPI.MMEMORY.LOAD.STATE

:MMEM:LOAD:CHAN**Type**

Command

Syntax

:MMEMory:LOAD:CHANnel[:STATe] {A|B|C|D}

Description

This command recalls the instrument state for an individual channel from the specified register as the setting of the active channel.

Variable

Parameter	Selection Option
Description	Register
Data Type	Character string type (String)
Range	A B C D

Examples

E4990A Impedance Analyzer Help

```
Dim Var as String
Var= "A"
Ana.WriteString ":MMEM:LOAD:CHAN " & Var, True
```

Related Commands

[:MMEM:STOR:CHAN](#)

[:DISP:WIND:ACT](#)

Equivalent Softkey

Save/Recall > **Recall Channel** > **Unknown A | Unknown B | Unknown C | Unknown D**

COM Command Syntax (Internal Control Only)

SCPI.MMEMORY.LOAD.CHANNEL.STATE

:MMEM:LOAD:CHAN:COEF

Type

Command

Syntax

:MMEMory:LOAD:CHANnel:COEFFicient {A|B|C|D}

Description

This command recalls the channel coefficient data of the active channel from the specified register.

Variable

Parameter	Selection Option
Description	Register
Data Type	Character string type (String)
Range	A B C D

Examples

```
Dim Var as String
Var= "A"
Ana.WriteString ":MMEM:LOAD:CHAN " & Var, True
```

Related Commands

[:MMEM:STOR:CHAN](#)

[:DISP:WIND:ACT](#)

Equivalent Softkey

Save/Recall > **Recall Channel** > **Cal Only A | Cal Only B | Cal Only C | Cal Only D**

COM Command Syntax (Internal Control Only)

SCPI.MMEMORY.LOAD.CHANNEL.COEFFICIENT

:MMEM:LOAD:LIM**Type**

Command

Syntax

:MMEMory:LOAD:LIMit <Value>

Description

This command load the specified limit table file of active channel from CSV file (file with the .csv extension saved with [:MMEM:STOR:LIM](#)).

NOTE

Specify the file name with the extension. When you use directory names and file name, separate them with "\" (back slash), or "/" (slash).

Variable

Parameter	Value
Description	File name to save the limit table (extension ".csv")
Data Type	Character string type (String)
Range	254 chars

Examples

```
Dim Var as String
Var = "D:\limit.csv"
Ana.WriteString ":MMEM:LOAD:LIM " & Var, True
```

Related Commands[:DISP:WIND:ACT](#)[:CALC:PAR:SEL](#)[:MMEM:STOR:LIM](#)**Equivalent Softkey****Analysis > Limit Test > Edit Limit Line > Import from CSV File...****COM Command Syntax (Internal Control Only)**

SCPI.MMEMORY.LOAD.LIMIT

:MMEM:LOAD:SEGM**Type**

Command

Syntax

:MMEMory:LOAD:SEGMENT <Value>

Description

E4990A Impedance Analyzer Help

This command load the specified segment table file of active channel from CSV file (file with a .csv extension saved with the: [:MMEM:STOR:SEGM](#)).

NOTE

Specify the file name with the extension. When you use directory names and file name, separate them with "\" (back slash), or "/" (slash).

Variable

Parameter	Value
Description	File name (extension ".csv")
Data Type	Character string type (String)
Range	254 chars

Examples

```
Dim Var as String
Var = "D:\segtable1.csv"
Ana.WriteString ":MMEM:LOAD:SEGM " & Var, True
```

Related Commands

[:DISP:WIND:ACT](#)

[:MMEM:STOR:SEGM](#)

Equivalent Softkey

Sweep Setup > Edit Segment Table > Import from CSV File...

COM Command Syntax (Internal Control Only)

```
SCPI.MMEMORY.LOAD.SEGMENT
```

```
:MMEM:MDIR
```

Type

Command

Syntax

```
:MMEMory:MDIRectory <Value>
```

Description

This command creates a new directory (folder).

NOTE

When you create a directory under an existing directory, separate between the directory names with "\" (back slash), or "/" (slash).

Variable

Parameter	Value
Description	Directory name you want to create

Data Type	Character string type (String)
Range	254 chars

Examples

```
Dim Var as String
Var = "mysetup1"
Ana.WriteString ":MMEM:MDIR " & Var, True
```

Equivalent Softkey

No equivalent key is available on the front panel.

COM Command Syntax (Internal Control Only)

```
SCPI.MMEMORY.MDIRECTORY
```

:MMEM:STOR**Type**

Command

Syntax

```
:MMEMory:STORe[:STATe] <Value>
```

Description

This command saves the instrument state (contents to be saved specified with the [:MMEM:STOR:STYP](#)) into a file (file with the .sta extension).

State1 to **State8** are named as "State1.sta" to "State8.sta" and saved into D: directory.

Autorec and **UserPres** are named as "Autorec.sta" and "UserPres.sta" and saved into D: directory.

NOTE

Specify the file name with the extension. When you use directory names and file name, separate them with "\" (back slash), or "/" (slash).

Variable

Parameter	Value
Description	File name to save the instrument state (extension ".sta")
Data Type	Character string type (String)
Range	254 chars

Examples

```
Dim FType as String, Var as String
FType= "STATE"
Var = "mystate1.sta"
```

E4990A Impedance Analyzer Help

```
Ana.WriteString ":MMEM:STOR:STYP " & FType, True  
Ana.WriteString ":MMEM:STOR " & Var, True
```

Related Commands

[:MMEM:STOR:STYP](#)

[:MMEM:LOAD](#)

[:MMEM:STOR:SALL](#)

Equivalent Softkey

Save/Recall > **Save State** > **State01** to **State08**

Save/Recall > **Save State** > **Autorec**

Save/Recall > **Save State** > **UserPres**

Save/Recall > **Save State** > **File Dialog...**

COM Command Syntax (Internal Control Only)

```
SCPI.MMEMORY.STORE.STATE
```

:MMEM:STOR:CHAN

Type

Command

Syntax

```
:MMEMory:STORe:CHANnel[:STATe] {A|B|C|D}
```

Description

This command saves the instrument state of the items set for the active channel specific to that channel only into the specified register (volatile memory).

Variable

Parameter	Selection Option
Description	Register
Data Type	Character string type (String)
Range	A B C D

Examples

```
Dim Var as String  
Var= "A"  
Ana.WriteString ":MMEM:STOR:CHAN " & Var, True
```

Related Commands

[:MMEM:LOAD:CHAN](#)

[:DISP:WIND:ACT](#)

Equivalent Softkey

Save/Recall > **Save Channel** > **State & Cal A | State & Cal B | State & Cal C | State & Cal D**

COM Command Syntax (Internal Control Only)

SCPI.MMEMORY.STORE.CHANNEL.STATE

:MMEM:STOR:CHAN:CLE

Type

Command

Syntax

:MMEMory:STORe:CHANnel:CLEar

Description

This command deletes the instrument state for each channel (saved with the [:MMEM:STOR:CHAN](#)) in all the registers.

Examples

Ana.WriteString ":MMEM:STOR:CHAN:CLE", True

Related Commands

[:MMEM:STOR:CHAN](#)

Equivalent Softkey

Save/Recall > **Save Channel** > **Clear States** > **OK**

COM Command Syntax (Internal Control Only)

SCPI.MMEMORY.STORE.CHANNEL.CLEAR

:MMEM:STOR:CHAN:COEF

Type

Command

Syntax

:MMEMory:STORe:CHANnel:COEFFicient {A|B|C|D}

Description

This command saves the channel coefficient data of the active channel specific to that channel only into the specified register (volatile memory).

Variable

Parameter	Selection Option
Description	Register
Data Type	Character string type (String)
Range	A B C D

Examples

E4990A Impedance Analyzer Help

```
Dim Var as String
Var= "A"
Ana.WriteString ":MMEM:STOR:CHAN:COEF " & Var, True
```

Related Commands

[:MMEM:LOAD:CHAN](#)

[:DISP:WIND:ACT](#)

Equivalent Softkey

Save/Recall > **Save Channel** > **Cal Only A** | **Cal Only B** | **Cal Only C** | **Cal Only D**

COM Command Syntax (Internal Control Only)

```
SCPI.MMEMORY.STORE.CHANNEL.COEFFICIENT
```

:MMEM:STOR:EPAR

Type

Command

Syntax

```
:MMEMory:STORe:EPARameters <Value>
```

Description

This command saves the equivalent circuit parameters of an active channel into a CSV file at defined location.

NOTE

Specify the file name with the extension. When you use directory names and file name, separate them with "\" (back slash), or "/" (slash).

Variable

Parameter	Value
Description	Filename and destination name you want save
Data Type	Character string type (String)
Range	254 chars

Examples

```
Dim Var as String
Var= "C:\sample.csv"
Ana.WriteString ":MMEM:STOR:EPAR " & Var, True
```

Equivalent Softkey

There is no equivalent key available on the front panel. However, similar key which exports to TXT file is shown below:

Analysis > **Equivalent Circuit** > **Export to TXT File...**

COM Command Syntax (Internal Control Only)

```
SCPI.MMEMORY.STORE.EPARAMETERS
```

:MMEM:STOR:FDAT**Type**

Command

Syntax

:MMEMory:STORe:FDATa <Value>

Description

This command saves the formatted data array for the active trace of the active channel into a file in the CSV format (extension ".csv"). If you want to save several traces at one time, use :MMEM:STOR:TRAC.

NOTE

Specify the file name with the extension. When you use directory names and file name, separate them with "\" (back slash), or "/" (slash).

Variable

Parameter	Value
Description	File name in which you want to save the formatted data array (extension ".csv")
Data Type	Character string type (String)
Range	254 chars

Examples

```
Dim Var as String
Var = "D:\data1.csv"
Ana.WriteString ":MMEM:STOR:FDAT" & Var, True
```

Related Commands[:DISP:WIND:ACT](#)[:CALC:PAR:SEL](#)

:MMEM:STOR:TRAC

Equivalent Softkey**Save/Recall > Save Trace Data... > Single****COM Command Syntax (Internal Control Only)**

SCPI.MMEMORY.STORE.FDATA

:MMEM:STOR:IMAG**Type**

Command

Syntax

:MMEMory:STORe:IMAGe <Value>

Description

E4990A Impedance Analyzer Help

This command saves the display image on the LCD display (screen image) at the execution of the object into a file in the bitmap (extension ".bmp") or portable network graphics (extension ".png") format.

NOTE

Specify the file name with the extension. When you use directory names and file name, separate them with "\" (back slash), or "/" (slash).

Variable

Parameter	Value
Description	File name in which you want to save the display image on the LCD display (extension ".bmp" or ".png")
Data Type	Character string type (String)
Range	254 chars

Examples

```
Dim Var as String
Var = "D:\img.png"
Ana.WriteString ":MMEM:STOR:IMAG " & Var, True
```

Equivalent Softkey**System > Dump Screen Image...****COM Command Syntax (Internal Control Only)**

```
SCPI.MMEMORY.STORE.IMAGE
```

:MMEM:STOR:LIM**Type**

Command

Syntax

```
:MMEMory:STORe:LIMit <Value>
```

Description

This command saves the limit table of the active trace of the active channel into a file in the CSV format (extension ".csv").

NOTE

Specify the file name with the extension. When you use directory names and file name, separate them with "\" (back slash), or "/" (slash).

Variable

Parameter	Value
Description	File name to save the limit table (extension ".csv")

Data Type	Character string type (String)
Range	254 chars

Examples

```
Dim Var as String
Var = "D:\limit.csv"
Ana.WriteString ":MMEM:STOR:LIM " & Var, True
```

Related Commands

[:DISP:WIND:ACT](#)

[:CALC:PAR:SEL](#)

[:MMEM:LOAD:LIM](#)

Equivalent Softkey

Analysis > **Limit Test** > **Edit Limit Line** > **Export to CSV File...**

COM Command Syntax (Internal Control Only)

SCPI.MMEMORY.STORE.LIMIT

:MMEM:STOR:S1P

Type

Command

Syntax

:MMEMory:STORe:S1P[:DATA] <Value>

Description

This command saves the measurement data for the active channel into a file in the touchstone format.

NOTE

Specify the file name with the extension. When you use directory names and file name, separate them with "\" (back slash), or "/" (slash).

Variable

Parameter	Value
Description	Touchstone file format
Data Type	Character string type (String)
Range	254 chars

Examples

```
Dim Var as String
Var = "TS1.s1p"
Ana.WriteString ":MMEM:STOR:S1P" & Var, True
```

E4990A Impedance Analyzer Help

Related Commands

[:DISP:WIND:ACT](#)

[:MMEM:STOR:S1P:FORM](#)

Equivalent Softkey

Save/Recall > **Save S1P** > **SaveS1P**

COM Command Syntax (Internal Control Only)

SCPI.MMEMORY.STORE.S1P.DATA

:MMEM:STOR:S1P:FORM

Type

Command/Query

Syntax

:MMEMory:STORe:S1P:FORMat {MA|DB|RI}

:MMEMory:STORe:S1P:FORMat?

Description

This command sets/gets the data format for saving measurement data for the active channel into a file in the touchstone format.

Variable

Parameter	Selection Option
Description	Touchstone file format
Data Type	Character string type (String)
Range	MA : LinMag/Angle DB : LogMag/Angle RI : Real/Imaginary
Preset Value	MA

Query Response

{MA|DB|RI} <newline> < ^END >

Examples

```
Dim Var as String
Var= "DB"
Ana.WriteString ":MMEM:STOR:S1P:FORM " & Var, True
Ana.WriteString ":MMEM:STOR:S1P:FORM?", True
Var=Ana.ReadString
```

Related Commands[:DISP:WIND:ACT](#)[:MMEM:STOR:S1P](#)**Equivalent Softkey****Save/Recall > Save S1P > S1P Format****COM Command Syntax (Internal Control Only)**

SCPI.MMEMORY.STORE.S1P.FORMAT

:MMEM:STOR:SALL**Type**

Command/Query

Syntax

:MMEMory:STORe:SALL {ON|OFF|1|0}

:MMEMory:STORe:SALL?

Description

This command selects whether to save the settings of all channels/traces state or that of the displayed channels/traces state only, as the instrument state to be saved.

Variable

Parameter	Selection Option
Description	Selecting content to be saved as the instrument state setting.
Data Type	Boolean type (Boolean)
Range	ON OFF 1 0
Preset Value	OFF

Query Response

{1|0} <newline> <^END>

Examples

Dim Var as Boolean

Var= 1

Ana.WriteString ":MMEM:STOR:SALL " & Str(Var), True

E4990A Impedance Analyzer Help

```
Ana.WriteString ":MMEM:STOR:SALL?", True  
Var=Ana.ReadNumber
```

Related Commands

[:MMEM:STOR](#)

[:MMEM:STOR:STYP](#)

Equivalent Softkey

Save/Recall > Channel/Trace

COM Command Syntax (Internal Control Only)

```
SCPI.MMEMORY.STORE.SALL
```

:MMEM:STOR:SEGM

Type

Command

Syntax

```
:MMEMory:STORe:SEGMENT <Value>
```

Description

This command saves the segment table of the active channel into a file in the CSV format (extension ".csv").

NOTE

Specify the file name with the extension. When you use directory names and file name, separate them with "\" (back slash), or "/" (slash).

Variable

Parameter	Value
Description	File name (extension ".csv")
Data Type	Character string type (String)
Range	254 chars

Examples

```
Dim Var as String  
Var = "D:\segtable1.csv"  
Ana.WriteString ":MMEM:STOR:SEGM " & Var, True
```

Related Commands

[:DISP:WIND:ACT](#)

[:MMEM:LOAD:SEGM](#)

Equivalent Softkey

Sweep Setup > Edit Segment Table > Export to CSV File...

COM Command Syntax (Internal Control Only)

SCPI.MMEMORY.STORE.SEGMENT

:MMEM:STOR:STYP

Type

Command/Query

Syntax

:MMEMory:STORe:STYPe {STATe|CSTate|DSTate|CDSTate}

:MMEMory:STORe:STYPe?

Description

The command selects the contents saved when saving the instrument state into a file with the [:MMEM:STOR](#).

Variable

Parameter	Selection Option
Description	Data of instrument state
Data Type	Character string type (String)
Range	STATe : Instrument State Only CSTate : Instrument States and Calibration Data DSTate : Instrument States and Trace Data CDSTate : Instrument States, Calibration and Trace Data (All)
Preset Value	CSTate

Query Response

{STAT|CST|DST|CDST}<newline><^END>

Examples

See [:MMEM:STOR](#).

Related Commands

[:MMEM:STOR](#)

Equivalent Softkey

Save/Recall > **Save Type**

COM Command Syntax (Internal Control Only)

SCPI.MMEMORY.STORE.STYPE

:MMEM:TRAN

Type

Command/Query

Syntax

:MMEMory:TRANSfer <Value>

Description

This command transfers data (file) between the built-in storage device of the E4990A and external PC through SCPI command, but not through COM command.

NOTE

When you use directory names and file name, separate them with "/" (slash) or "\" (backslash). If a file with the specified file name already exists for writing or if the specified file does not exist for reading out (Query), an error occurs and the command is ignored.

Variable

Parameter	Value
Description	File name on the built-in storage device
Data Type	Character string type (String)
Range	254 chars

Query Response

{Byte} <newline> < ^END>

Examples

See [Transferring Files](#).

Equivalent Softkey

No equivalent key is available on the front panel.

COM Command Syntax (Internal Control Only)

SCPI.MMEMORY.TRANSFER

SENSE

:SENS:ADAP

Type

Command/Query

Syntax

```
:SENSe:ADAPter[:TYPE] {NONE|E4M1|E4M2|E4A7|E4AE7|E4PR|E4PE}
```

```
:SENSe:ADAPter[:TYPE]?
```

Description

This command sets/gets the adapter type.

Variable

Parameter	Selection Option
Description	Adapter type
Data Type	Character string type (String)
Range	NONE: None E4M1: 4TP 1m E4M2: 4TP 2m E4A7: 7mm 42942A E4AE7: 42942A Extension E4PR: Probe 42941A E4PE: 42941A Extension
Preset Value	NONE

Query Response

```
{NONE|E4M1|E4M2|E4A7|E4AE7|E4PR|E4PE} <newline> < ^END>
```

Examples

```
Dim Var as String
Var= "E4M1"
Ana.WriteString ":SENS:ADAP " & Var, True
Ana.WriteString ":SENS:ADAP?", True
Var=Ana.ReadString
```

Related Commands

[:SENS:FIXT:SEL](#)

Equivalent Softkey

Cal > **Adapter**

Instrument Setup > **Adapter**

COM Command Syntax (Internal Control Only)

```
SCPI.SENSE.ADAPTER.TYPE
```

:SENS<Ch>:ADAP:CORR:COLL

Type

Command

Syntax

```
:SENSe:ADAPter:CORRection:COLLect[:ACQuire]
{OPEN|SHORT|LOAD|PHASe}
```

Description

This command measures the adapter setup standard.

Variable

Parameter	Selection Option
Description	Adapter setup standard
Data Type	Character string type (String)
Range	OPEN: Open SHORT: Short LOAD: Load or E4990-61001 PHASe: Phase

Examples

```
Dim Var as String
Var= "OPEN"
Ana.WriteString ":SENS:ADAP:CORR:COLL " & Var, True
```

Related Commands

[:SENS:ADAP:CORR:COLL:SAVE](#)

Equivalent Softkey

- Cal** > Adapter Setup > Phase
- Cal** > Adapter Setup > Open
- Cal** > Adapter Setup > Short
- Cal** > Adapter Setup > Load
- Cal** > Adapter Setup > E4990-61001
- Instrument Setup** > Adapter Setup > Phase
- Instrument Setup** > Adapter Setup > Open
- Instrument Setup** > Adapter Setup > Short
- Instrument Setup** > Adapter Setup > Load
- Instrument Setup** > Adapter Setup > E4990-61001

COM Command Syntax (Internal Control Only)

SCPI.SENSE.ADAPTER.CORRECTION.COLLECT.ACQUIRE

:SENS:ADAP:CORR:COLL:SAVE

Type

Command

Syntax

:SENSe:ADAPter:CORRection:COLLect:SAVE {IMPedance|PHASe}

Description

This command calculates the adapter setup data.

Variable

Parameter	Selection Option
Description	Adapter setup type
Data Type	Character string type (String)
Range	IMPedance PHASe

Examples

Dim Var as String

Var= "IMP"

Ana.WriteString ":SENS:ADAP:CORR:COLL:SAVE " & Var, True

Related Commands

[:SENS:ADAP:CORR:COLL](#)

Equivalent Softkey

Cal > Adapter Setup > Save Phase

Cal > Adapter Setup > Save Impedance

Instrument Setup > Adapter Setup > Save Phase

Instrument Setup > Adapter Setup > Save Impedance

COM Command Syntax (Internal Control Only)

SCPI.SENSE.ADAPTER.CORRECTION.COLLECT.SAVE

:SENS<Ch>:APER

Type

Command/Query

Syntax

:SENSe<Ch>:APERture[:TIME] <Value>

:SENSe<Ch>:APERture[:TIME]?

Description

This command sets/gets the measurement speed. 1 is the fastest setting.

Variable

E4990A Impedance Analyzer Help

Parameter	Value
Description	Measurement speed
Data Type	Numeric type (Integer)
Range	1 2 3 4 5
Preset Value	1

Query Response

{ numeric } <newline> < ^END >

Examples

```
Dim Var as Long
Var= 5
Ana.WriteString ":SENS1:APER " & Str(Var), True
Ana.WriteString ":SENS1:APER?", True
Var=Ana.ReadNumber
```

Related Commands

[:SENS:SWE:TIME](#)

Equivalent Softkey

Average > **Meas Time**

Instrument Setup > **Meas Time**

COM Command Syntax (Internal Control Only)

SCPI.SENSE(Ch).APERTURE.TIME

:SENS<Ch>:AVER

Type

Command/Query

Syntax

:SENSe<Ch>:AVERage[:STATe] {ON|OFF|1|0}

:SENSe<Ch>:AVERage[:STATe]?

Description

This command sets/gets the point averaging state.

Variable

Parameter	Selection Option
Description	Point averaging On/Off state

Data Type	Boolean type (Boolean)
Range	ON OFF 1 0
Preset Value	OFF

Query Response

```
{1|0} <newline> < ^END>
```

Examples

```
Dim Var as Integer
Ana.WriteString ":SENS1: AVER ON", True
Ana.WriteString ":SENS1: AVER?", True
Var=Ana.ReadNumber
```

Related Commands

[:SENS: AVER: COUN](#)

Equivalent Softkey

Average > Point Avg

COM Command Syntax (Internal Control Only)

```
SCPI.SENSE(Ch).AVERAGE.STATE
```

:SENS<Ch>: AVER: COUN

Type

Command/Query

Syntax

```
:SENSe<Ch>: AVERage: COUNT <Value>
```

```
:SENSe<Ch>: AVERage: COUNT?
```

Description

This command sets/gets the point averaging factor.

Variable

Parameter	Value
Description	Averaging factor
Data Type	Numeric type (Integer)
Range	1 ~ 999
Preset Value	16

E4990A Impedance Analyzer Help

Unit	-
Resolution	1

Query Response

{ numeric } <newline> < ^END >

Examples

```
Dim Var as Long
Var= 10
Ana.WriteString ":SENS1:AVER:COUN " & Str(Var), True
Ana.WriteString ":SENS1:AVER:COUN?", True
Var=Ana.ReadNumber
```

Related Commands

[:SENS:AVER](#)

Equivalent Softkey

Average > **Point Avg Factor**

COM Command Syntax (Internal Control Only)

SCPI.SENSE(Ch).AVERAGE.COUNT

:SENS<Ch>:CORR<Type>:CKIT:LOAD:C

Type

Command/Query

Syntax

:SENSe<Ch>:CORRection<Type>:CKIT:LOAD:C <Value>

:SENSe<Ch>:CORRection<Type>:CKIT:LOAD:C?

Description

This command sets/gets the load capacitance value for the user calibration and fixture compensation.

(<type>: User calibration=1, Fixture Compensation=2)

Variable

Parameter	Value
Description	Load capacitance value
Data Type	Numeric type (Real)
Range	-1M ~ 1M

Preset Value	0
Unit	F
Resolution	-

Query Response

```
{ numeric} <newline> < ^END>
```

Examples

```
Dim Var as Double
Var= -1000000
Ana.WriteString ":SENS1:CORR1:CKIT:LOAD:C " & Str(Var), True
Ana.WriteString ":SENS1:CORR1:CKIT:LOAD:C?", True
Var=Ana.ReadNumber
```

Related Commands

[:SENS:CORR:CKIT:LOAD:MOD](#)

Equivalent Softkey

Cal > **User Cal** > **Define Value** > **Load Cap (C)**

Cal > **Fixture Compens** > **Define Value** > **Load Cap (C)**

COM Command Syntax (Internal Control Only)

```
SCPI.SENSE(Ch).CORRECTION(Type).CKIT.LOAD.C
```

```
:SENS<Ch>:CORR<Type>:CKIT:LOAD:L
```

Type

Command/Query

Syntax

```
:SENSe<Ch>:CORRection<Type>:CKIT:LOAD:L <Value>
```

```
:SENSe<Ch>:CORRection<Type>:CKIT:LOAD:L?
```

Description

This command sets/gets the load inductance value for the user calibration and fixture compensation.

(<type>: User calibration=1, Fixture Compensation=2)

Variable

Parameter	Value
Description	Load inductance value
Data Type	Numeric type (Real)

E4990A Impedance Analyzer Help

Range	-1M ~ 1M
Preset Value	0
Unit	H
Resolution	1p

Query Response

{ numeric } <newline> < ^END>

Examples

```
Dim Var as Double
Var= -1000000
Ana.WriteString ":SENS1:CORR1:CKIT:LOAD:L " & Str(Var), True
Ana.WriteString ":SENS1:CORR1:CKIT:LOAD:L?", True
Var=Ana.ReadNumber
```

Related Commands

[:SENS:CORR:CKIT:LOAD:MOD](#)

Equivalent Softkey

Cal > **User Cal** > **Define Value** > **Load Induct (L)**

Cal > **Fixture Compens** > **Define Value** > **Load Induct (L)**

COM Command Syntax (Internal Control Only)

SCPI.SENSE(Ch).CORRECTION(Type).CKIT.LOAD.L

:SENS<Ch>:CORR<Type>:CKIT:LOAD:MOD

Type

Command/Query

Syntax

:SENSe<Ch>:CORRection<Type>:CKIT:LOAD:MODeI {EQUIv|TABLe}

:SENSe<Ch>:CORRection<Type>:CKIT:LOAD:MODeI?

Description

This command selects the load standard impedance model for the user calibration and fixture compensation.

(<type>: User calibration=1, Fixture Compensation=2)

Variable

Parameter	Selection Option
Description	Load standard impedance model

Data Type	Character string type (String)
Range	EQUiv: Equivalent Circuit TABLE: f-Z Table
Preset Value	EQUiv

Query Response

```
{ EQU|TABL } <newline> < ^END >
```

Examples

```
Dim Var as String
Var= "EQU"
Ana.WriteString ":SENS1:CORR1:CKIT:LOAD:MOD " & Var, True
Ana.WriteString ":SENS1:CORR1:CKIT:LOAD:MOD?", True
Var=Ana.ReadString
```

Related Commands

[:SENS:CORR:CKIT:LOAD:TABL](#)

[:SENS:CORR:CKIT:LOAD:C](#)

[:SENS:CORR:CKIT:LOAD:L](#)

[:SENS:CORR:CKIT:LOAD:R](#)

Equivalent Softkey

Cal > **User Cal** > **Define Value** > **Load Model** > **Equivalent Circuit | f-Z Table**

Cal > **Fixture Compens** > **Define Value** > **Load Model** > **Equivalent Circuit | f-Z Table**

COM Command Syntax (Internal Control Only)

```
SCPI.SENSE(Ch).CORRECTION(Type).CKIT.LOAD.MODEL
```

```
:SENS<Ch>:CORR<Type>:CKIT:LOAD:R
```

Type

Command/Query

Syntax

```
:SENSe<Ch>:CORRection<Type>:CKIT:LOAD:R <Value>
```

```
:SENSe<Ch>:CORRection<Type>:CKIT:LOAD:R?
```

Description

This command sets/gets the load resistance value for the user calibration and fixture compensation.

(<type>: User calibration=1, Fixture Compensation=2)

Variable

E4990A Impedance Analyzer Help

Parameter	Value
Description	Load resistance
Data Type	Numeric type (Real)
Range	-100G ~ 100G
Preset Value	50
Unit	Ω
Resolution	1p

Query Response

{ numeric } <newline> < ^END >

Examples

```
Dim Var as Double
Var= -100000000000
Ana.WriteString ":SENS1:CORR1:CKIT:LOAD:R " & Str(Var), True
Ana.WriteString ":SENS1:CORR1:CKIT:LOAD:R?", True
Var=Ana.ReadNumber
```

Related Commands

[:SENS:CORR:CKIT:LOAD:MOD](#)

Equivalent Softkey

Cal > **User Cal** > **Define Value** > **Load Resist (R)**

Cal > **Fixture Compens** > **Define Value** > **Load Resist (R)**

COM Command Syntax (Internal Control Only)

SCPI.SENSE(Ch).CORRECTION(Type).CKIT.LOAD.R

:SENS<Ch>:CORR<Type>:CKIT:LOAD:TABLE

Type

Command/Query

Syntax

:SENSe<Ch>:CORRection<Type>:CKIT:LOAD:TABLE <Value 1>, ... ,
<Value (n×3+1)>

:SENSe<Ch>:CORRection<Type>:CKIT:LOAD:TABLE?

Description

This command defines the table of load model for the user calibration and fixture compensation.

(<type>: User calibration=1, Fixture Compensation=2)

Variable

Parameter	Value
Description	<p>Load standard definition table:</p> <p>Indicates the array data of $1 + \text{NOP}$ (number of standard data points) $\times 3$. Where n is an integer between 1 and NOP.</p> <p><value 1> : The number of standard data points you want to set. Specify an integer ranging 1 to 1601.</p> <p><Value (n\times3-1)> : Frequency at the n-th of standard data.</p> <p><Value (n\times3)> : Real part of data (complex number) at the n-th standard data point.</p> <p><Value (n\times3+1)> : Imaginary part of data (complex number) at the n-th standard data point.</p>
Data Type	Variant type Array (Range)
Preset Value	0

Query Response

{ numeric 1 }, ... , { numeric (n \times 3+1) } <newline> < ^END >

Examples

```
Dim SetTableAry() as Double
SetTableAry = Array(3, 1000000#, 50.1, 0, 2000000#, 50.05, 0, 3000000#, 51, 0)
Ana.WriteString ":SENS1:CORR1:CKIT:LOAD:TABL " & SetTableAry(), True
Ana.WriteString ":SENS1:CORR1:CKIT:LOAD:TABL?", True
SetTableAry=Ana.ReadList(ASCIIType_R8, ",")
```

Related Commands

[:SENS:CORR:CKIT:LOAD:MOD](#)

[:SENS:CORR:CKIT:OPEN:TABL](#)

[:SENS:CORR:CKIT:SHOR:TABL](#)

Equivalent Softkey

No equivalent key is available on the front panel.

E4990A Impedance Analyzer Help

COM Command Syntax (Internal Control Only)

SCPI.SENSE(Ch).CORRECTION(Type).CKIT.LOAD.TABLE
:SENS<Ch>:CORR<Type>:CKIT:OPEN:C
Type

Command/Query

Syntax

:SENSe<Ch>:CORRection<Type>:CKIT:OPEN:C <Value>
:SENSe<Ch>:CORRection<Type>:CKIT:OPEN:C?

Description

This command sets/gets the open capacitance value for the user calibration and fixture compensation.

(<type>: User calibration=1, Fixture Compensation=2)

Variable

Parameter	Value
Description	Open capacitance value
Data Type	Numeric type (Real)
Range	-1M ~ 1M
Preset Value	0
Unit	F
Resolution	-

Query Response

{ numeric } <newline> < ^END >

Examples

```
Dim Var as Double
Var= -1000000
Ana.WriteString ":SENS1:CORR1:CKIT:OPEN:C " & Str(Var), True
Ana.WriteString ":SENS1:CORR1:CKIT:OPEN:C?", True
Var=Ana.ReadNumber
```

Related Commands

[:SENS:CORR:CKIT:OPEN:MOD](#)

Equivalent Softkey

Cal > User Cal > Define Value > Open Cap (C)

Cal > Fixture Compens > Define Value > Open Cap (C)

COM Command Syntax (Internal Control Only)

SCPI.SENSE(Ch).CORRECTION(Type).CKIT.OPEN.C

:SENS<Ch>:CORR<Type>:CKIT:OPEN:G

Type

Command/Query

Syntax

:SENSe<Ch>:CORRection<Type>:CKIT:OPEN:G <Value>

:SENSe<Ch>:CORRection<Type>:CKIT:OPEN:G?

Description

This command sets/gets the open conductance value for the user calibration and fixture compensation.

(<type>: User calibration=1, Fixture Compensation=2)

Variable

Parameter	Value
Description	Open conductance value
Data Type	Numeric type (Real)
Range	-1M ~ 1M
Preset Value	0
Unit	S
Resolution	1p

Query Response

{ numeric } <newline> < ^END >

Examples

Dim Var as Double

Var= -1000000

Ana.WriteString ":SENS1:CORR1:CKIT:OPEN:G " & Str(Var), True

Ana.WriteString ":SENS1:CORR1:CKIT:OPEN:G?", True

Var=Ana.ReadNumber

Related Commands

[:SENS:CORR:CKIT:OPEN:C](#)

Equivalent Softkey

Cal > User Cal > Define Value > Open Conduct (G)

Cal > Fixture Compens > Define Value > Open Conduct (G)

COM Command Syntax (Internal Control Only)

SCPI.SENSE(Ch).CORRECTION(Type).CKIT.OPEN.G

:SENS<Ch>:CORR<Type>:CKIT:OPEN:MOD

Type

Command/Query

Syntax

:SENSe<Ch>:CORRection<Type>:CKIT:OPEN:MODEl {EQUiv|TABLE}

:SENSe<Ch>:CORRection<Type>:CKIT:OPEN:MODEl?

Description

This command selects the open standard impedance model for the user calibration and fixture compensation.

(<type>: User calibration=1, Fixture Compensation=2)

Variable

Parameter	Selection Option
Description	Open standard impedance model
Data Type	Character string type (String)
Range	EQUiv: Equivalent Circuit TABLE: f-Z Table
Preset Value	EQUiv

Query Response

{EQU|TABL} <newline> < ^END>

Examples

```
Dim Var as String
Var= "EQU"
Ana.WriteString ":SENS1:CORR1:CKIT:OPEN:MOD " & Var, True
Ana.WriteString ":SENS1:CORR1:CKIT:OPEN:MOD?", True
Var=Ana.ReadString
```

Related Commands

[:SENS:CORR:CKIT:OPEN:C](#)

[:SENS:CORR:CKIT:OPEN:G](#)

[:SENS:CORR:CKIT:OPEN:TABL](#)

Equivalent Softkey

Cal > **User Cal** > **Define Value** > **Open Model** > **Equivalent Circuit | f-Z Table**

Cal > **Fixture Compens** > **Define Value** > **Open Model** > **Equivalent Circuit | f-Z Table**

COM Command Syntax (Internal Control Only)

SCPI.SENSE(Ch).CORRECTION(Type).CKIT.OPEN.MODEL

:SENS<Ch>:CORR<Type>:CKIT:OPEN:TABL

Type

Command/Query

Syntax

:SENSe<Ch>:CORREction<Type>:CKIT:OPEN:TABLE <Value 1>, ... ,
<Value (n×3+1)>

:SENSe<Ch>:CORREction<Type>:CKIT:OPEN:TABLE?

Description

This command defines the table of open model for the user calibration and fixture compensation.

(<type>: User calibration=1, Fixture Compensation=2)

Variable

Parameter	Value
Description	<p>Open standard definition table:</p> <p>Indicates the array data of 1 + NOP (number of standard data points) × 3. Where n is an integer between 1 and NOP.</p> <p><value 1> :The number of standard data points you want to set. Specify an integer ranging 1 to 1601.</p> <p><Value (n×3-1)> :Frequency at the n-th of standard data.</p> <p><Value (n×3)> :Real part of data (complex number) at the n-th standard data point.</p> <p><Value (n×3+1)> :Imaginary part of data (complex number) at the n-th standard data point.</p>
Data Type	Variant type Array (Range)
Preset	0

Value	
--------------	--

Query Response

{ numeric 1 }, ... , { numeric (n×3+1) } <newline> < ^END >

Examples

```
Dim SetTableAry() as Double
SetTableAry = Array(3, 1000000#, 50.1, 0, 2000000#, 50.05, 0, 3000000#, 51, 0)
Ana.WriteString ":SENS1:CORR1:CKIT:OPEN:TABL " & SetTableAry(), True
Ana.WriteString ":SENS1:CORR1:CKIT:OPEN:TABL?", True
SetTableAry=Ana.ReadList(ASCIIType_R8, ",")
```

Related Commands

- [:SENS:CORR:CKIT:OPEN:MOD](#)
- [:SENS:CORR:CKIT:SHOR:TABL](#)
- [:SENS:CORR:CKIT:LOAD:TABL](#)

Equivalent Softkey

No equivalent key is available on the front panel.

COM Command Syntax (Internal Control Only)

SCPI.SENSE(Ch).CORRECTION(Type).CKIT.OPEN.TABLE

:SENS<Ch>:CORR<Type>:CKIT:SHOR:L

Type

Command/Query

Syntax

:SENSe<Ch>:CORRection<Type>:CKIT:SHORT:L <Value>

:SENSe<Ch>:CORRection<Type>:CKIT:SHORT:L?

Description

This command sets/gets the short inductance value for the user calibration and fixture compensation.

(<type>: User calibration=1, Fixture Compensation=2)

Variable

Parameter	Value
Description	Short inductance value
Data Type	Numeric type (Real)
Range	-1M ~ 1M

Preset Value	0
Unit	H
Resolution	1p

Query Response

```
{ numeric} <newline> < ^END>
```

Examples

```
Dim Var as Double
Var= -1000000
Ana.WriteString ":SENS1:CORR1:CKIT:SHOR:L " & Str(Var), True
Ana.WriteString ":SENS1:CORR1:CKIT:SHOR:L?", True
Var=Ana.ReadNumber
```

Related Commands

[:SENS:CORR:CKIT:SHOR:MOD](#)

Equivalent Softkey

Cal > **User Cal** > **Define Value** > **Short Induct (L)**

Cal > **Fixture Compens** > **Define Value** > **Short Induct (L)**

COM Command Syntax (Internal Control Only)

```
SCPI.SENSE(Ch).CORRECTION(Type).CKIT.SHORT.L
```

```
:SENS<Ch>:CORR<Type>:CKIT:SHOR:MOD
```

Type

Command/Query

Syntax

```
:SENSe<Ch>:CORRection<Type>:CKIT:SHORT:MODEl {EQUIv|TABLE}
```

```
:SENSe<Ch>:CORRection<Type>:CKIT:SHORT:MODEl?
```

Description

This command selects the short standard impedance model for the user calibration and fixture compensation.

(<type>: User calibration=1, Fixture Compensation=2)

Variable

Parameter	Selection Option
Description	Short standard impedance model
Data Type	Character string type (String)

E4990A Impedance Analyzer Help

Range	EQUiv: Equivalent Circuit TABLE: f-Z Table
Preset Value	EQUiv

Query Response

{ EQU|TABL } <newline> < ^END >

Examples

```
Dim Var as String
Var= "EQU"
Ana.WriteString ":SENS1:CORR1:CKIT:SHOR:MOD " & Var, True
Ana.WriteString ":SENS1:CORR1:CKIT:SHOR:MOD?", True
Var=Ana.ReadString
```

Related Commands

[:SENS:CORR:CKIT:SHOR:L](#)

[:SENS:CORR:CKIT:SHOR:R](#)

[:SENS:CORR:CKIT:SHOR:TABL](#)

Equivalent Softkey

Cal > **User Cal** > **Define Value** > **Short Model** > **Equivalent Circuit | f-Z Table**

Cal > **Fixture Compens** > **Define Value** > **Short Model** > **Equivalent Circuit | f-Z Table**

COM Command Syntax (Internal Control Only)

SCPI.SENSE(Ch).CORRECTION(Type).CKIT.SHORT.MODEL

:SENS<Ch>:CORR<Type>:CKIT:SHOR:R

Type

Command/Query

Syntax

:SENSe<Ch>:CORRection<Type>:CKIT:SHORt:R <Value>

:SENSe<Ch>:CORRection<Type>:CKIT:SHORt:R?

Description

This command sets/gets the short resistance value for the user calibration and fixture compensation.

(<type>: User calibration=1, Fixture Compensation=2)

Variable

Parameter	Value
-----------	-------

Description	Short resistance value
Data Type	Numeric type (Real)
Range	-1M ~ 1M
Preset Value	0
Unit	Ω
Resolution	1p

Query Response

```
{ numeric} <newline> < ^END>
```

Examples

```
Dim Var as Double
Var= -1000000
Ana.WriteString ":SENS1:CORR1:CKIT:SHOR:R " & Str(Var), True
Ana.WriteString ":SENS1:CORR1:CKIT:SHOR:R?", True
Var=Ana.ReadNumber
```

Related Commands

[:SENS:CORR:CKIT:SHOR:MOD](#)

Equivalent Softkey

Cal > **User Cal** > **Define Value** > **Short Resist (R)**

Cal > **Fixture Compen** > **Define Value** > **Short Resist (R)**

COM Command Syntax (Internal Control Only)

```
SCPI.SENSE(Ch).CORRECTION(Type).CKIT.SHORT.R
```

```
:SENS<Ch>:CORR<Type>:CKIT:SHOR:TABL
```

Type

Command/Query

Syntax

```
:SENSe<Ch>:CORRection<Type>:CKIT:SHORT:TABLE <Value 1>, ... ,
<Value (n×3+1)>
```

```
:SENSe<Ch>:CORRection<Type>:CKIT:SHORT:TABLE?
```

Description

This command defines the table of short model for the user calibration and fixture compensation.

(<type>: User calibration=1, Fixture Compensation=2)

Variable

Parameter	Value
Description	<p>Short standard definition table:</p> <p>Indicates the array data of $1 + \text{NOP}$ (number of standard data points) $\times 3$. Where n is an integer between 1 and NOP.</p> <p><value 1> : The number of standard data points you want to set. Specify an integer ranging 1 to 1601.</p> <p><Value ($n \times 3 - 1$)> : Frequency at the n-th of standard data.</p> <p><Value ($n \times 3$)> : Real part of data (complex number) at the n-th standard data point.</p> <p><Value ($n \times 3 + 1$)> : Imaginary part of data (complex number) at the n-th standard data point.</p>
Data Type	Variant type Array (Range)
Preset Value	0

Query Response

```
{ numeric 1 }, ... , { numeric ( $n \times 3 + 1$ ) } <newline> < ^END >
```

Examples

```
Dim SetTableAry() as Double
SetTableAry = Array(3, 1000000#, 0.1, 0, 2000000#, 0.05, 0, 3000000#, 0.5, 0)
Ana.WriteString ":SENS1:CORR1:CKIT:SHOR:TABL " & SetTableAry(), True
Ana.WriteString ":SENS1:CORR1:CKIT:SHOR:TABL?", True
SetTableAry=Ana.ReadList(ASCIIType_R8, ",")
```

Related Commands

[:SENS:CORR:CKIT:SHOR:MOD](#)

[:SENS:CORR:CKIT:OPEN:TABL](#)

[:SENS:CORR:CKIT:LOAD:TABL](#)

Equivalent Softkey

No equivalent key is available on the front panel.

COM Command Syntax (Internal Control Only)

```
SCPI.SENSE(Ch).CORRECTION(Type).CKIT.SHORT.TABLE
```

```
:SENS<Ch>:CORR<Type>:CLE
```

Type

Command

Syntax

```
:SENSe<Ch>:CORRection<Type>:CLEAr
```

Description

This command clears the calibration parameters.

<type>: User calibration=1, Fixture Compensation=2

Examples

```
Ana.WriteString ":SENS1:CORR1:CLE", True
```

Related Commands

[:SENS:CORR:STAT](#)

Equivalent Softkey

No equivalent key is available on the front panel.

COM Command Syntax (Internal Control Only)

```
SCPI.SENSE(Ch).CORRECTION(Type).CLEAR
```

:SENS<Ch>:CORR<Type>:COLL:ACQ:LOAD

Type

Command

Syntax

```
:SENSe<Ch>:CORRection<Type>:COLLect:ACQuire:LOAD
```

Description

This command measures the load data for the user calibration and the fixture compensation.

<type>: User calibration=1, Fixture Compensation=2

In the user calibration, the [:SENS:CORR:COLL:SAVE](#) should be executed after open/short/load calibrations.

Examples

```
Ana.WriteString ":SENS1:CORR1:COLL:ACQ:LOAD", True
```

Related Commands

[:SENS:CORR:COLL:ACQ:OPEN](#)

[:SENS:CORR:COLL:ACQ:SHOR](#)

[:SENS:CORR:COLL:SAVE](#)

Equivalent Softkey

Cal > User Cal > Execute Cal > Load

Cal > Fixture Compen > Load (Optional)

COM Command Syntax (Internal Control Only)

```
SCPI.SENSE(Ch).CORRECTION(Type).COLLECT.ACQUIRE.LOAD
```

:SENS<Ch>:CORR<Type>:COLL:ACQ:OPEN

Type

E4990A Impedance Analyzer Help

Command

Syntax

:SENSe<Ch>:CORRection<Type>:COLLect:ACQuire:OPEN

Description

This command measures the open data for the user calibration and the fixture compensation.

<type>: User calibration=1, Fixture Compensation=2

In the user calibration, the [:SENS:CORR:COLL:SAVE](#) should be executed after open/short/load calibrations.

Examples

Ana.WriteString ":SENS1:CORR1:COLL:ACQ:OPEN", True

Related Commands

[:SENS:CORR:COLL:ACQ:LOAD](#)

[:SENS:CORR:COLL:ACQ:SHOR](#)

[:SENS:CORR:COLL:SAVE](#)

Equivalent Softkey

Cal > **User Cal** > **Execute Cal** > **Open**

Cal > **Fixture Compen** > **Open (x S x F)**

COM Command Syntax (Internal Control Only)

SCPI.SENSE(Ch).CORRECTION(Type).COLLECT.ACQUIRE.OPEN

:SENS<Ch>:CORR<Type>:COLL:ACQ:SHOR

Type

Command

Syntax

:SENSe<Ch>:CORRection<Type>:COLLect:ACQuire:SHORT

Description

This command measures the short data for the user calibration and the fixture compensation.

<type>: User calibration=1, Fixture Compensation=2

In the user calibration, the [:SENS:CORR:COLL:SAVE](#) should be executed after open/short/load calibrations.

Examples

Ana.WriteString ":SENS1:CORR1:COLL:ACQ:SHOR", True

Related Commands

[:SENS:CORR:COLL:ACQ:LOAD](#)

[:SENS:CORR:COLL:ACQ:OPEN](#)

[:SENS:CORR:COLL:SAVE](#)

Equivalent Softkey

Cal > User Cal > Execute Cal > Short

Cal > Fixture Compen > Short (x Ω x H)

COM Command Syntax (Internal Control Only)

SCPI.SENSE(Ch).CORRECTION(Type).COLLECT.ACQUIRE.SHORT

:SENS<Ch>:CORR<Type>:COLL:CLE

Type

Command

Syntax

:SENSe<Ch>:CORRection<Type>:COLLect:CLEar

Description

This command clears the measured data.

Examples

Ana.WriteString ":SENS1:CORR1:COLL:CLE", True

Related Commands

[:SENS:CORR:COLL:ACQ:LOAD](#)

[:SENS:CORR:COLL:ACQ:OPEN](#)

[:SENS:CORR:COLL:ACQ:SHOR](#)

Equivalent Softkey

Cal > User Cal > Execute Cal > Cancel > OK

COM Command Syntax (Internal Control Only)

SCPI.SENSE(Ch).CORRECTION(Type).COLLECT.CLEAR

:SENS<Ch>:CORR:COLL:FPO

Type

Command/Query

Syntax

:SENSe<Ch>:CORRection:COLLect:FPOints {FIXed|USER}

:SENSe<Ch>:CORRection:COLLect:FPOints?

Description

This command selects the frequency point type for both user calibration and fixture compensation. The same type is applied to both user calibration and fixture compensation.

Variable

Parameter	Selection Option
Description	Frequency point type
Data Type	Character string type (String)

E4990A Impedance Analyzer Help

Range	FIXed USER
Preset Value	FIXed

Query Response

{FIX|USER}<newline>< ^END>

Examples

```
Dim Var as String
Var= "FIX"
Ana.WriteString ":SENS1:CORR:COLL:FPO " & Var, True
Ana.WriteString ":SENS1:CORR:COLL:FPO?", True
Var=Ana.ReadString
```

Related Commands

[:SENS:CORR:COLL:SAVE](#)
[:SENS:CORR:COLL:ACQ:LOAD](#)
[:SENS:CORR:COLL:ACQ:OPEN](#)
[:SENS:CORR:COLL:ACQ:SHOR](#)

Equivalent Softkey

Cal > Compen Point

Instr Setup > Fixture Compen > Compen Point

COM Command Syntax (Internal Control Only)

SCPI.SENSE(Ch).CORRECTION.COLLECT.FPOINTS

:SENS<Ch>:CORR1:COLL:SAVE

Type

Command

Syntax

:SENSe<Ch>:CORRection1:COLLect:SAVE

Description

This command calculates the user calibration data after open/short/load measurements.

SENS:CORR2:COLL:SAVE causes an undefined header error.

Examples

```
Ana.WriteString ":SENS1:CORR1:COLL:SAVE", True
```

Related Commands

[:SENS:CORR:COLL1:ACQ:LOAD](#)
[:SENS:CORR:COLL1:ACQ:OPEN](#)
[:SENS:CORR:COLL1:ACQ:SHOR](#)

Equivalent Softkey

Cal > User Cal > Execute Cal > Done**COM Command Syntax (Internal Control Only)**

SCPI.SENSE(Ch).CORRECTION(1).COLLECT.SAVE

:SENS<Ch>:CORR2:EDEL:LENG**Type**

Command/Query

Syntax

:SENSe<Ch>:CORRection2:EDELay:LENGth <Value>

:SENSe<Ch>:CORRection2:EDELay:LENGth?

Description

This command sets/gets the extension value in meter.

SENS:CORR1:EDEL:LENG causes an undefined header error.

Variable

Parameter	Value
Description	Extension
Data Type	Numeric type (Real)
Range	-
Preset Value	0
Unit	meter
Resolution	-

Query Response

{numeric} <newline> < ^END>

Examples

```
Dim Var as Double
Ana.WriteString ":SENS1:CORR2:EDEL:LENG " & Var, True
Ana.WriteString ":SENS1:CORR2:EDEL:LENG?", True
Var=Ana.ReadString
```

Related Commands

[:SENS:CORR:EDEL:STAT](#)

[:SENS:CORR:EDEL:TIME](#)

Equivalent Softkey

Cal > Port Extension > Extension (Length)

COM Command Syntax (Internal Control Only)

SCPI.SENSE(Ch).CORRECTION(2).EDELAY.LENGTH

:SENS<Ch>:CORR2:EDEL:STAT

Type

Command/Query

Syntax

:SENSe<Ch>:CORRection2:EDELay:STATe {ON|OFF|1|0}

:SENSe<Ch>:CORRection2:EDELay:STATe?

Description

This command sets/gets the port extension state.

SENS:CORR1:EDEL:STAT causes an undefined header error.

Variable

Parameter	Selection Option
Description	Port extension On/Off status
Data Type	Boolean type (Boolean)
Range	ON OFF 1 0
Preset Value	OFF

Query Response

{1|0} <newline> < ^END>

Examples

```
Dim Var as Integer
Ana.WriteString ":SENS1:CORR2:EDEL:STAT ON", True
Ana.WriteString ":SENS1:CORR2:EDEL:STAT?", True
Var=Ana.ReadNumber
```

Related Commands

[:SENS:CORR:EDEL:LENG](#)

[:SENS:CORR:EDEL:TIME](#)

Equivalent Softkey

Cal > Port Extension > Extension

COM Command Syntax (Internal Control Only)

SCPI.SENSE(Ch).CORRECTION(2).EDELAY.STATE

:SENS<Ch>:CORR2:EDEL:TIME**Type**

Command/Query

Syntax

:SENSe<Ch>:CORRection2:EDELay:TIME <Value>

:SENSe<Ch>:CORRection2:EDELay:TIME?

Description

This command sets/gets the port extension value in time.

SENS:CORR1:EDEL:TIME causes an undefined header error.

Variable

Parameter	Value
Description	Port extension value
Data Type	Numeric type (Real)
Range	-
Preset Value	0
Unit	sec
Resolution	-

Query Response

{ numeric } <newline> < ^END >

Examples

```
Dim Var as Double
Ana.WriteString ":SENS1:CORR1:EDEL:TIME ON", True
Ana.WriteString ":SENS1:CORR1:EDEL:TIME?", True
Var=Ana.ReadNumber
```

Related Commands[:SENS:CORR:EDEL:STAT](#)[:SENS:CORR:EDEL:LENG](#)**Equivalent Softkey****Cal > Port Extension > Extension (Time)****COM Command Syntax (Internal Control Only)**

SCPI.SENSE(Ch).CORRECTION(Type).EDELAY.TIME

:SENS<Ch>:CORR2:LOAD

Type

Command/Query

Syntax

:SENSe<Ch>:CORRection2:LOAD[:STATe] {ON|OFF|1|0}

:SENSe<Ch>:CORRection2:LOAD[:STATe]?

Description

This command sets/gets the Load fixture compensation On/Off status. SENS:CORR1:LOAD causes an undefined header error.

Variable

Parameter	Selection Option
Description	Load fixture compensation On/Off status
Data Type	Boolean type (Boolean)
Range	ON OFF 1 0
Preset Value	OFF

Query Response

{1|0} <newline> < ^END >

Examples

```
Dim Var as Integer
Ana.WriteString ":SENS1:CORR2:LOAD ON", True
Ana.WriteString ":SENS1:CORR2:LOAD?", True
Var=Ana.ReadNumber
```

Related Commands

[:SENS:CORR:COLL:ACQ:LOAD](#)

[:SENS:CORR:OPEN](#)

[:SENS:CORR:SHOR](#)

[:SENS:CORR:STAT](#)

Equivalent Softkey

Cal > Fixture Compen > Load

COM Command Syntax (Internal Control Only)

SCPI.SENSE(Ch).CORRECTION(2).LOAD.STATE

:SENS<Ch>:CORR2:OPEN

Type

Command/Query

Syntax

```
:SENSe<Ch>:CORRection2:OPEN[:STATe] {ON|OFF|1|0}
```

```
:SENSe<Ch>:CORRection2:OPEN[:STATe]?
```

Description

This command sets/gets the open fixture compensation On/Off status.

SENS:CORR1:OPEN causes an undefined header error.

Variable

Parameter	Selection Option
Description	Open fixture compensation On/Off status
Data Type	Boolean type (Boolean)
Range	ON OFF 1 0
Preset Value	OFF

Query Response

```
{1|0}<newline><^END>
```

Examples

```
Dim Var as Integer
Ana.WriteString ":SENS1:CORR2:OPEN ON", True
Ana.WriteString ":SENS1:CORR2:OPEN?", True
Var=Ana.ReadNumber
```

Related Commands

[:SENS:CORR:COLL:ACQ:OPEN](#)

[:SENS:CORR:LOAD](#)

[:SENS:CORR:SHOR](#)

[:SENS:CORR:STAT](#)

Equivalent Softkey

Cal > Fixture Compen > Open

COM Command Syntax (Internal Control Only)

```
SCPI.SENSE(Ch).CORRECTION(2).OPEN.STATE
```

:SENS<Ch>:CORR2:SHOR

Type

Command/Query

E4990A Impedance Analyzer Help

Syntax

:SENSe<Ch>:CORRection2:SHORt[:STATe] {ON|OFF|1|0}

:SENSe<Ch>:CORRection2:SHORt[:STATe]?

Description

This command sets/gets the short fixture compensation On/Off status.

SENS:CORR1:SHOR causes an undefined header error.

Variable

Parameter	Selection Option
Description	Short fixture compensation On/Off status
Data Type	Boolean type (Boolean)
Range	ON OFF 1 0
Preset Value	OFF

Query Response

{1|0} <newline> <^END>

Examples

```
Dim Var as Integer
Ana.WriteString ":SENS1:CORR2:SHOR ON", True
Ana.WriteString ":SENS1:CORR2:SHOR?", True
Var=Ana.ReadNumber
```

Related Commands

[:SENS:CORR:COLL:ACO:SHOR](#)

[:SENS:CORR:OPEN](#)

[:SENS:CORR:LOAD](#)

[:SENS:CORR:STAT](#)

Equivalent Softkey

Cal > Fixture Compen > Short

COM Command Syntax (Internal Control Only)

SCPI.SENSE(Ch).CORRECTION(2).SHORT.STATE

:SENS<Ch>:CORR1:STAT

Type

Command/Query

Syntax

:SENSe<Ch>:CORRection1:STATe {ON|OFF|1|0}

:SENSe<Ch>:CORRection1:STATe?

Description

This command sets/gets the user calibration On/Off status.

SENS:CORR2:STATE causes an undefined header error.

Variable

Parameter	Selection Option
Description	User calibration On/Off status
Data Type	Boolean type (Boolean)
Range	ON OFF 1 0
Preset Value	OFF

Query Response

{1|0}<newline><^END>

Examples

```
Dim Var as Integer
Ana.WriteString ":SENS1:CORR1:STAT ON", True
Ana.WriteString ":SENS1:CORR1:STAT?", True
Var=Ana.ReadNumber
```

Related Commands

[:SENS:CORR:OPEN](#)

[:SENS:CORR:SHOR](#)

[:SENS:CORR:LOAD](#)

Equivalent Softkey

Cal > **User Cal** > **Correction**

COM Command Syntax (Internal Control Only)

SCPI.SENSE(Ch).CORRECTION(1).STATE

:SENS<Ch>:CORR1:ZME:FREQ

Type

Query

Syntax

:SENSe<Ch>:CORRection1:ZMEas:FREQuency?

Description

E4990A Impedance Analyzer Help

This command gets the frequency stimulus array for the user calibration. The array size (number of point) is returned by [:SENS:CORR:ZME:POIN](#).

Query Response

{numeric}, ... , {numeric} <newline> <^END>

Examples

```
Dim Var as Variant
Ana.WriteString ":SENS1:CORR1:ZME:FREQ?", True
Var=Ana.ReadList(ASCIIType_R8, ",")
```

Related Commands

[:SENS:CORR:ZME:POIN](#)

Equivalent Softkey

No equivalent key is available on the front panel.

COM Command Syntax (Internal Control Only)

SCPI.SENSE(Ch).CORRECTION(1).ZMEAS.FREQUENCY

:SENS<Ch>:CORR<Type>:ZME:LOAD

Type

Command/Query

Syntax

:SENSe<Ch>:CORRection<Type>:ZMEas:LOAD[: DATA] <Value>

:SENSe<Ch>:CORRection<Type>:ZMEas:LOAD[: DATA]?

Description

This command sets/gets the actual impedance array of Load standard for the user calibration and the fixture compensation.

<type>: User calibration=1, Fixture Compensation=2

The array size (number of point):

- User calibration: 2 × (value returned by [:SENS:CORR:ZME:POIN](#))
- Fixture compensation: 2 × (value returned by [:SENS:CORR:ZME:LOAD:POIN](#))

Variable

Parameter	Value
Description	Load standard impedance array
Data Type	Variant type Array (Range)

Query Response

{numeric}, ... , {numeric} <newline> < ^END>

Examples

```
Dim Var as Variant
Ana.WriteString ":SENS1:CORR1:ZME:LOAD " & Var(), True
Ana.WriteString ":SENS1:CORR1:ZME:LOAD?", True
Var=Ana.ReadList(ASCIIType_R8, ",")
```

Related Commands

[:SENS:CORR:ZME:OPEN](#)

[:SENS:CORR:ZME:SHOR](#)

[:SENS:CORR:ZME:LOAD:POIN](#)

[:SENS:CORR:ZME:POIN](#)

Equivalent Softkey

No equivalent key is available on the front panel.

COM Command Syntax (Internal Control Only)

SCPI.SENSE(Ch).CORRECTION(Type).ZMEAS.LOAD.DATA

:SENS<Ch>:CORR2:ZME:LOAD:FREQ

Type

Query

Syntax

:SENSe<Ch>:CORRection2:ZMEas:LOAD:FREQuency?

Description

This command gets the frequency stimulus array of Load standard for fixture compensation. The array size (number of point) is returned by [:SENS:CORR:ZME:LOAD:POIN](#). SENS:CORR1:ZME:LOAD:FREQ causes an undefined header error.

Query Response

{numeric}, ... , {numeric} <newline> < ^END>

Examples

```
Dim Var as Variant
Ana.WriteString ":SENS1:CORR2:ZME:LOAD:FREQ?", True
Var=Ana.ReadList(ASCIIType_R8, ",")
```

Related Commands

[:SENS:CORR:ZME:LOAD:POIN](#)

Equivalent Softkey

No equivalent key is available on the front panel.

COM Command Syntax (Internal Control Only)

SCPI.SENSE(Ch).CORRECTION(2).ZMEAS.LOAD.FREQUENCY

:SENS<Ch>:CORR2:ZME:LOAD:POIN

Type

Query

Syntax

:SENSe<Ch>:CORRection2:ZMEas:LOAD:POINTs?

Description

This command returns the number of points of frequency stimulus array of Load for the fixture compensation. SENS:CORR1:ZME:LOAD:POIN causes an undefined header error.

Query Response

{ numeric } <newline> < ^END >

Examples

```
Dim Var as Long
Ana.WriteString ":SENS1:CORR2:ZME:LOAD:POIN?", True
Var=Ana.ReadNumber
```

Related Commands

[:SENS:CORR:ZME:LOAD:FREQ](#)

Equivalent Softkey

No equivalent key is available on the front panel.

COM Command Syntax (Internal Control Only)

SCPI.SENSE(Ch).CORRECTION(2).ZMEAS.LOAD.POINTS

:SENS<Ch>:CORR<Type>:ZME:OPEN

Type

Command/Query

Syntax

:SENSe<Ch>:CORRection<Type>:ZMEas:OPEN[: DATA] <Value>

:SENSe<Ch>:CORRection<Type>:ZMEas:OPEN[: DATA]?

Description

This command gets the actual impedance array of the open standard for the fixture compensation. <type>: User calibration=1, Fixture Compensation=2

The array size (number of point):

- User calibration: 2 × (value returned by [:SENS:CORR:ZME:POIN](#))
- Fixture compensation: 2 × (value returned by [:SENS:CORR:ZME:OPEN:POIN](#))

Variable

Parameter	Value
Description	Open standard impedance array
Data Type	Variant type Array (Range)

Query Response

{numeric}, ... , {numeric} <newline> < ^END>

Examples

See [:SENS:CORR:ZME:LOAD](#)

Related Commands

[:SENS:CORR:ZME:SHOR](#)

[:SENS:CORR:ZME:LOAD](#)

[:SENS:CORR:ZME:OPEN:POIN](#)

[:SENS:CORR:ZME:POIN](#)

Equivalent Softkey

No equivalent key is available on the front panel.

COM Command Syntax (Internal Control Only)

SCPI.SENSE(Ch).CORRECTION(2).ZMEAS.OPEN.DATA

:SENS<Ch>:CORR2:ZME:OPEN:FREQ

Type

Query

Syntax

:SENSe<Ch>:CORRection2:ZMEas:OPEN:FREQuency?

Description

This command returns the frequency stimulus array of the open standard for the fixture compensation. The array size (number of point) is returned by: [:SENS:CORR:ZME:OPEN:POIN](#). SENS:CORR1:ZME:OPEN:FREQ causes an undefined header error.

Variable**Query Response**

{numeric}, ... , {numeric} <newline> < ^END>

Examples

```
Dim Var as Variant
Ana.WriteString ":SENS1:CORR2:ZME:OPEN:FREQ?", True
Var=Ana.ReadList(ASCIIType_R8, ",")
```

E4990A Impedance Analyzer Help

Related Commands

[:SENS:CORR:ZME:OPEN:POIN](#)

Equivalent Softkey

No equivalent key is available on the front panel.

COM Command Syntax (Internal Control Only)

SCPI.SENSE(Ch).CORRECTION(2).ZMEAS.OPEN.FREQUENCY

:SENS<Ch>:CORR2:ZME:OPEN:POIN

Type

Query

Syntax

:SENSe<Ch>:CORRection2:ZMEas:OPEN:POINTs?

Description

This command returns the number of points of frequency stimulus array of open for the fixture compensation. SENS:CORR1:ZME:OPEN:POIN causes an undefined header error.

Query Response

{numeric} <newline> < ^END >

Examples

```
Dim Var as Long
Ana.WriteString ":SENS1:CORR2:ZME:OPEN:POIN?", True
Var=Ana.ReadNumber
```

Related Commands

[:SENS:CORR:ZME:OPEN:FREQ](#)

Equivalent Softkey

No equivalent key is available on the front panel.

COM Command Syntax (Internal Control Only)

SCPI.SENSE(Ch).CORRECTION(2).ZMEAS.OPEN.POINTS

:SENS<Ch>:CORR1:ZME:POIN

Type

Query

Syntax

:SENSe<Ch>:CORRection1:ZMEas:POINTs?

Description

This command returns the number of points of the frequency stimulus array for the user calibration. SENS:CORR2:ZME:POIN causes an undefined header error.

Query Response

{numeric} <newline> < ^END >

Examples

```
Dim Var as Long
Ana.WriteString ":SENS1:CORR1:ZME:POIN?", True
Var=Ana.ReadNumber
```

Related Commands

[:SENS:CORR:ZME:FREQ](#)

[:SENS:CORR:ZME:LOAD](#)

[:SENS:CORR:ZME:OPEN](#)

[:SENS:CORR:ZME:SHOR](#)

Equivalent Softkey

No equivalent key is available on the front panel.

COM Command Syntax (Internal Control Only)

SCPI.SENSE(Ch).CORRECTION(1).ZMEAS.POINTS

:SENS<Ch>:CORR<Type>:ZME:SHOR

Type

Command/Query

Syntax

:SENSe<Ch>:CORRection<Type>:ZMEas:SHORT[:DATA] <Value>

:SENSe<Ch>:CORRection<Type>:ZMEas:SHORT[:DATA]?

Description

This command sets/gets the actual impedance array of the short standard for the user calibration and the fixture compensation.

<type>: User calibration=1, Fixture Compensation=2

The array size (number of point):

- User calibration: 2 × (value returned by [:SENS:CORR:ZME:POIN](#))
- Fixture compensation: 2 × (value returned by [:SENS:CORR:ZME:SHOR:POIN](#))

Variable

Parameter	Value
Description	Short standard impedance array
Data Type	Variant type Array (Range)

Query Response

{numeric}, ... , {numeric} <newline> <^END>

E4990A Impedance Analyzer Help

Examples

See [:SENS:CORR:ZME:LOAD](#)

Related Commands

[:SENS:CORR:ZME:OPEN](#)

[:SENS:CORR:ZME:LOAD](#)

[:SENS:CORR:ZME:SHOR:POIN](#)

[:SENS:CORR:ZME:POIN](#)

Equivalent Softkey

No equivalent key is available on the front panel.

COM Command Syntax (Internal Control Only)

SCPI.SENSE(Ch).CORRECTION(Type).ZMEAS.SHORT.DATA

:SENS<Ch>:CORR2:ZME:SHOR:FREQ

Type

Query

Syntax

:SENSe<Ch>:CORRection2:ZMEas:SHORt:FREQuency?

Description

This command returns the frequency stimulus array of the short standard for the fixture compensation. The array size (number of point) is returned by [:SENS:CORR:ZME:SHOR:POIN](#). SENS:CORR1:ZME:SHOR:FREQ causes an undefined header error.

Query Response

{numeric}, ... , {numeric} <newline> <^END>

Examples

```
Dim Var as Variant
Ana.WriteString ":SENS1:CORR2:ZME:SHOR:FREQ?", True
Var=Ana.ReadList(ASCIIType_R8, ",")
```

Related Commands

[:SENS:CORR:ZME:SHOR:POIN](#)

Equivalent Softkey

No equivalent key is available on the front panel.

COM Command Syntax (Internal Control Only)

SCPI.SENSE(Ch).CORRECTION(2).ZMEAS.SHORT.FREQUENCY

:SENS<Ch>:CORR2:ZME:SHOR:POIN

Type

Query

Syntax

:SENSe<Ch>:CORRection2:ZMEas:SHORt:POINts?

Description

This command returns the number of points of frequency stimulus array of short for the fixture compensation. SENS:CORR1:ZME:SHOR:POIN causes an undefined header error.

Query Response

```
{ numeric } <newline> < ^END >
```

Examples

```
Dim Var as Long
Ana.WriteString ":SENS1:CORR2:ZME:SHOR:POIN?", True
Var=Ana.ReadNumber
```

Related Commands

[:SENS:CORR:ZME:SHOR:FREQ](#)

Equivalent Softkey

No equivalent key is available on the front panel.

COM Command Syntax (Internal Control Only)

```
SCPI.SENSE(Ch).CORRECTION(2).ZMEAS.SHORT.POINTS
```

```
:SENS<Ch>:DC:MEAS:CLE
```

Type

Command

Syntax

```
:SENSe<Ch>:DC:MEASure:CLEar
```

Description

This command clears DC Monitor measurement data.

Examples

```
Ana.WriteString ":SENS1:DC:MEAS:CLE", True
```

Related Commands

[:SENS:DC:MEAS:ENAB](#)

Equivalent Softkey

Meas > **DC Monitor Setup** > **Clear**

COM Command Syntax (Internal Control Only)

```
SCPI.SENSE(Ch).DC.MEASURE.CLEAR
```

```
:SENS<Ch>:DC:MEAS:DATA:DCI
```

Type

Query

Syntax

```
:SENSe<Ch>:DC:MEASure:DATA:DCI?
```

Description

This command returns the DC Monitor current measurement data at the sweep start.

E4990A Impedance Analyzer Help

Query Response

{ numeric } <newline> < ^END >

Examples

```
Dim Var as Double
Ana.WriteString ":SENS1:DC:MEAS:DATA:DCI?", True
Var=Ana.ReadNumber
```

Related Commands

[:SENS:DC:MEAS:ENAB](#)

Equivalent Softkey

No equivalent key is available on the front panel.
(DC monitor result at right-upper corner on screen)

COM Command Syntax (Internal Control Only)

SCPI.SENSE(Ch).DC.MEASURE.DATA.DCI

:SENS<Ch>:DC:MEAS:DATA:DCV

Type

Query

Syntax

:SENSe<Ch>:DC:MEASure:DATA:DCV?

Description

This command returns the DC Monitor voltage measurement data at the sweep start.

Query Response

{ numeric } <newline> < ^END >

Examples

```
Dim Var as Double
Ana.WriteString ":SENS1:DC:MEAS:DATA:DCV?", True
Var=Ana.ReadNumber
```

Related Commands

[:SENS:DC:MEAS:ENAB](#)

Equivalent Softkey

No equivalent key is available on the front panel.
(DC monitor display at right-upper corner)

COM Command Syntax (Internal Control Only)

SCPI.SENSE(Ch).DC.MEASURE.DATA.DCV

:SENS<Ch>:DC:MEAS:ENAB

Type

Command/Query

Syntax

:SENSe<Ch>:DC:MEASure:ENABLE {ON|OFF|1|0}

:SENSe<Ch>:DC:MEASure:ENABLE?

Description

This command enable/disable DC Monitor measurement at the sweep start.

Variable

Parameter	Selection Option
Description	DC Monitor measurement On/Off status
Data Type	Boolean type (Boolean)
Range	ON OFF 1 0
Preset Value	OFF

Query Response

{1|0} <newline> < ^END >

Examples

```
Dim Var as Integer
Ana.WriteString ":SENS1:DC:MEAS:ENAB ON", True
Ana.WriteString ":SENS1:DC:MEAS:ENAB?", True
Var=Ana.ReadNumber
```

Related Commands

[:SENS:DC:MEAS:DATA:DCI](#)

[:SENS:DC:MEAS:DATA:DCV](#)

Equivalent Softkey

Measurement > **DC Monitor Setup** > **DC Monitor**

COM Command Syntax (Internal Control Only)

SCPI.SENSE(Ch).DC.MEASURE.ENABLE

:SENS:FIXT:SEL

Type

Command/Query

Syntax

```
:SENSe: FIXTure: SElect
{ FIXT16034E|FIXT16044A|FIXT16047A|FIXT16047D|FIXT16047E|FIXT160
65A|FIXT16089|FIXT16034G|FIXT16034H|FIXT16334A|FIXT16092A|FIXT1
6192A|FIXT16194A|FIXT16196|FIXT16197A|FIXT42941A|ARBitrary}
```

:SENSe<Ch>:FREQUENCY[:CW] <Value>

:SENSe<Ch>:FREQUENCY[:CW]?

Description

This command sets/gets the continuous wave frequency.

Variable

Parameter	Value
Description	Continuous wave frequency
Data Type	Numeric type (Real)
Range	20 ~ 120M
Preset Value	1M
Unit	Hz
Resolution	1m

Query Response

{ numeric } <newline> < ^END >

Examples

```
Dim Var as Double
Var= 100000
Ana.WriteString ":SENS1:FREQ " & Str(Var), True
Ana.WriteString ":SENS1:FREQ?", True
Var=Ana.ReadNumber
```

Related Commands

[:SENS:SWE:TYPE](#)

Equivalent Softkey

Sweep Setup > **CW Freq**

COM Command Syntax (Internal Control Only)

SCPI.SENSE(Ch).FREQUENCY.CW

:SENS<Ch>:FREQ:CENT

Type

Command/Query

Syntax

E4990A Impedance Analyzer Help

:SENSe<Ch>:FREQUENCY:CENTer <Value>

:SENSe<Ch>:FREQUENCY:CENTer?

Description

This command sets/gets the center frequency in frequency sweep.

Variable

Parameter	Value
Description	Center frequency
Data Type	Numeric type (Real)
Range	20 to Maximum Frequency
Preset Value	60.00001M
Unit	Hz
Resolution	500 μ

Query Response

{ numeric } <newline> < ^END >

Examples

```
Dim Var as Double
Var= 1E6
Ana.WriteString ":SENS1:FREQ:CENT " & Str(Var), True
Ana.WriteString ":SENS1:FREQ:CENT?", True
Var=Ana.ReadNumber
```

Related Commands

[:SENS:FREQ:SPAN](#)

Equivalent Softkey

Center (in frequency sweep)

COM Command Syntax (Internal Control Only)

SCPI.SENSE(Ch).FREQUENCY.CENTER

:SENS<Ch>:FREQ:DATA

Type

Query

Syntax

:SENSe<Ch>:FREQUENCY:DATA?

Description

This command returns the frequency stimulus data.

Variable

Parameter	Value
Description	<p>Indicates the array data (frequency) of NOP (number of measurement points). Where n is an integer between 1 and NOP.</p> <p>Data(n-1): Frequency at the n-th measurement point</p> <p>The index of the array starts from 0.</p>
Data Type	Variant type Array (Range)

Query Response

```
{numeric 1}, ..., {numeric NOP} <newline> < ^END>
```

Examples

```
Dim Var as Variant
Ana.WriteString ":SENS1:FREQ:DATA?", True
Var=Ana.ReadList(ASCIIType_R8, ",")
```

Related Commands

[:SENS:FREQ](#)

Equivalent Softkey

No equivalent key is available on the front panel.

COM Command Syntax (Internal Control Only)

```
SCPI.SENSE(Ch).FREQUENCY.DATA
```

:SENS<Ch>:FREQ:SPAN

Type

Command/Query

Syntax

```
:SENSe<Ch>:FREQUENCY:SPAN <Value>
```

```
:SENSe<Ch>:FREQUENCY:SPAN?
```

Description

This command sets/gets the frequency span in frequency sweep.

Variable

Parameter	Value
Description	Frequency span

E4990A Impedance Analyzer Help

Data Type	Numeric type (Real)
Range	0 ~ 119.99998M
Preset Value	119.99998M
Unit	Hz
Resolution	1m

Query Response

{ numeric } <newline> < ^END >

Examples

```
Dim Var as Double
Var= 100000
Ana.WriteString ":SENS1:FREQ:SPAN " & Str(Var), True
Ana.WriteString ":SENS1:FREQ:SPAN?", True
Var=Ana.ReadNumber
```

Related Commands

[:SENS:FREQ:CENT](#)

Equivalent Softkey

Span (in frequency sweep)

COM Command Syntax (Internal Control Only)

SCPI.SENSE(Ch).FREQUENCY.SPAN

:SENS<Ch>:FREQ:STAR

Type

Command/Query

Syntax

:SENSe<Ch>:FREQuency:STARt <Value>

:SENSe<Ch>:FREQuency:STARt?

Description

This command sets/gets the start frequency in frequency sweep.

Variable

Parameter	Value
Description	Start frequency

Data Type	Numeric type (Real)
Range	20 to Maximum Frequency
Preset Value	20
Unit	Hz
Resolution	1m

Query Response

```
{ numeric } <newline> < ^END >
```

Examples

```
Dim Var as Double
Var= 1000
Ana.WriteString ":SENS1:FREQ:STAR " & Str(Var), True
Ana.WriteString ":SENS1:FREQ:STAR?", True
Var=Ana.ReadNumber
```

Related Commands

[:SENS:FREQ:STOP](#)

Equivalent Softkey

Start (in frequency sweep)

COM Command Syntax (Internal Control Only)

```
SCPI.SENSE(Ch).FREQUENCY.START
```

```
:SENS<Ch>:FREQ:STOP
```

Type

Command/Query

Syntax

```
:SENSe<Ch>:FREQuency:STOP <Value>
```

```
:SENSe<Ch>:FREQuency:STOP?
```

Description

This command sets/gets the stop frequency in frequency sweep.

Variable

Parameter	Value
Description	Stop frequency

E4990A Impedance Analyzer Help

Data Type	Numeric type (Real)
Range	20 to Maximum Frequency
Preset Value	120M
Unit	Hz
Resolution	1m

Query Response

{ numeric } <newline> < ^END >

Examples

```
Dim Var as Double
Var= 100E6
Ana.WriteString ":SENS1:FREQ:STOP " & Str(Var), True
Ana.WriteString ":SENS1:FREQ:STOP?", True
Var=Ana.ReadNumber
```

Related Commands

[:SENS:FREQ:STAR](#)

Equivalent Softkey

Stop (in frequency sweep)

COM Command Syntax (Internal Control Only)

SCPI.SENSE(Ch).FREQUENCY.STOP

:SENS:ROSC:SOUR

Type

Query

Syntax

:SENSe:ROSCillator:SOURce?

Description

This command returns whether the external reference signal is inputted to the Ref In connector on the rear panel.

Query Response

{ INT|EXT } <newline> < ^END >

INT: Internal

EXT: External reference signal is inputted

Examples

```
Dim Var as String
Ana.WriteString ":SENS:ROSC:SOUR?", True
Var=Ana.ReadString
```

Equivalent Softkey

Displayed on the [instrument status bar](#) (at the bottom of the LCD display).

COM Command Syntax (Internal Control Only)

```
SCPI.SENSE(Ch).ROSCILLATOR.SOURCE
```

:SENS<Ch>:SEGM:DATA

Type

Command/Query

Syntax

```
:SENSe<Ch>:SEGMent:DATA <Value>
```

```
:SENSe<Ch>:SEGMent:DATA?
```

Description

This command sets/gets the list for segment sweep.

Variable

Parameter	Value
Description	<p>Segment Table Setup</p> <p>Indicates the array data arranged in the following order (for the segment sweep table); where N is the number of segments (specified with <segm>) and n is an integer between 1 and N.</p> <p>Data = { <buf>, <stim mode>, <list OSC level on/off>, <list bias on/off>, <list meas time o/off>, <list average on/off>, <list segment time on/off>, <list delay time on/off>, <segm>, <star 1>, <stop 1>, <poin>, [OSC Level type 1],[OSC Level 1],[Bias type 1],[Bias Level 1],[meas time 1],[averaging factor 1],[segment time 1],[delay time 1], ... , [OSC Level type N],[OSC Level N],[Bias type N],[Bias Level N],[meas time N],[averaging factor N],[segment time N],[delay time N] }</p> <p>Each parameter in the above array data is detailed below:</p> <p><buf>: Always specify 7.</p> <p><stim mode>: Stimulus setting mode</p> <p>0: Specifies with start/stop values</p> <p>1: Specifies with center/span values</p>

<list OSC level on/off>: ON/OFF of the list OSC level for each segment

0: OFF, 1: ON

<list bias on/off>: ON/OFF of the list bias for each segment

0: OFF, 1: ON

<list meas time on/off>: ON/OFF of the meas time setting for each segment

0: OFF, 1: ON

<list average on/off>: ON/OFF of the average for each segment

0: OFF, 1: ON

<segment time on/off>: ON/OFF of the segment time setting for each segment

0: OFF, 1: ON

<delay time on/off>: ON/OFF of the delay time setting for each segment

0: OFF, 1: ON

<segm>: Number of segments. Specify an integer ranging 1 to 201.

<star n>: Start value/center value of the n-th segment

<stop n>: Stop value/span value of the n-th segment

<poin n>: number of measurement point of the n-th segment.

[OSC Level type n]: OSC level type: Voltage=0, Current=1. This is not necessary when <list OSC level on/off>=0.

[OSC Level n]: OSC level of the n-th segment. This is not necessary when <list OSC level on/off>=0.

[Bias type n]: DC Bias type: Voltage=0, Current=1. This is not necessary when <list Bias on/off>=0.

[Bias Level n]: DC Bias level of the n-th segment. This is not necessary when <list Bias on/off>=0.

[meas time n]: measurement time (1 to 5) of the n-th

	<p>segment. This is not necessary when <meas time on/off>=0.</p> <p>[averaging factor n]: averaging factor of the n-th segment. This is not necessary when <list average on/off>=0.</p> <p>[segment time n]: segment time of the n-th segment. This is not necessary when <segment time on/off>=0.</p> <p>[delay time n]: delay time of the n-th segment. This is not necessary when <delay time on/off>=0.</p> <p>If the necessary amount of array data for the specified number of segments is not available while setting the segment sweep table, an error occurs when its executed and the object is ignored.</p>
Data Type	Variant type Array (Range)
Preset Value	7,0,0,0,0,0,0,0,0,1,20,20,2

Query Response

{numeric}, ... , {numeric} <newline> <^END>

Examples

```
Dim Var as String
VariantAna.WriteString ":SENS1:SEGM:DATA 7, 0, 1, 0, 1, 1, 0, 0, 2, 1E6, 2E6, 10, 0, 5E-3, 1, 1, 3E6, 5E6, 20, 1, 2E-3, 5, 10", True
Ana.WriteString ":SENS1:SEGM:DATA?", True
Var=Ana.ReadString
```

	Start	Stop	Points	OSC Mode	OSC Level	Meas Time	Point Avg
1	1 MHz	2 MHz	10	Volt	5 mV	1	1
2	3 MHz	5 MHz	20	Curr	2 mA	5	10

Related Commands

[:SENS:SWE:TYPE](#)

[:SENS:SEGM:SWE:POIN](#)

Equivalent Softkey

Sweep Setup > **Edit Segment Table**

COM Command Syntax (Internal Control Only)

SCPI.SENSE(Ch).SEGMENT.DATA

:SENS<Ch>:SEGM:SWE:POIN

Type

Query

Syntax

:SENSe<Ch>:SEGMENT:SWEep:POINTs?

Description

This command returns the total number of points of segment sweep.

Query Response

{numeric} <newline> < ^END >

Examples

```
Dim Var as Long
Ana.WriteString ":SENS1:SEGM:SWE:POIN?", True
Var=Ana.ReadNumber
```

Related Commands

[:SENS:SEGM:DATA](#)

[:SENS:SWE:POIN](#)

Equivalent Softkey

No equivalent key is available on the front panel.

COM Command Syntax (Internal Control Only)

SCPI.SENSE(Ch).SEGMENT.SWEEP.POINTS

:SENS<Ch>:SWE:DEL

Type

Command/Query

Syntax

:SENSe<Ch>:SWEep:DELAy <Value>

:SENSe<Ch>:SWEep:DELAy?

Description

This command sets/gets the sweep delay time.

Variable

Parameter	Value
-----------	-------

Description	Sweep delay time
Data Type	Numeric type (Real)
Range	0 ~ 30
Preset Value	0
Unit	s
Resolution	1m

Query Response

```
{ numeric } <newline> < ^END >
```

Examples

```
Dim Var as Double
Var= 0.1
Ana.WriteString ":SENS1:SWE:DEL " & Str(Var), True
Ana.WriteString ":SENS1:SWE:DEL?", True
Var=Ana.ReadNumber
```

Related Commands

[:SENS:SWE:PDEL](#)

Equivalent Softkey

Sweep Setup > **Sweep Delay**

COM Command Syntax (Internal Control Only)

```
SCPI.SENSE(Ch).SWEEP.DELAY
```

```
:SENS<Ch>:SWE:DIR
```

Type

Command/Query

Syntax

```
:SENSe<Ch>:SWEep:DIRection { UP|DOWN}
```

```
:SENSe<Ch>:SWEep:DIRection?
```

Description

This command sets/gets the Sweep direction.

Variable

Parameter	Selection Option
------------------	------------------

E4990A Impedance Analyzer Help

Description	Sweep direction
Data Type	Character string type (String)
Range	UP DOWN
Preset Value	UP

Query Response

{UP|DOWN} <newline> < ^END>

Examples

```
Dim Var as String
Var= "UP"
Ana.WriteString ":SENS1:SWE:DIR " & Var, True
Ana.WriteString ":SENS1:SWE:DIR?", True
Var=Ana.ReadString
```

Related Commands

[:SENS:SWE:TYPE](#)

Equivalent Softkey

Sweep Setup > **Direction**

COM Command Syntax (Internal Control Only)

SCPI.SENSE(Ch).SWEEP.DIRECTION

:SENS<Ch>:SWE:PDEL

Type

Command/Query

Syntax

:SENSe<Ch>:SWEep:PDELay <Value>

:SENSe<Ch>:SWEep:PDELay?

Description

This command sets/gets the point delay time.

Variable

Parameter	Value
Description	Point Delay time
Data Type	Numeric type (Real)

Range	0 ~ 30
Preset Value	0
Unit	s
Resolution	1m

Query Response

{ numeric } <newline> < ^END >

Examples

```
Dim Var as Double
Var= 0.1
Ana.WriteString ":SENS1:SWE:PDEL " & Str(Var), True
Ana.WriteString ":SENS1:SWE:PDEL?", True
Var=Ana.ReadNumber
```

Related Commands

[:SENS:SWE:DEL](#)

Equivalent Softkey

Sweep Setup > **Point Delay**

COM Command Syntax (Internal Control Only)

SCPI.SENSE(Ch).SWEEP.PDELAY

:SENS<Ch>:SWE:POIN

Type

Command/Query

Syntax

:SENSe<Ch>:SWEep:POINts <Value>

:SENSe<Ch>:SWEep:POINts?

Description

This command sets/gets the number of points for stimulus.

Variable

Parameter	Value
Description	Number of point
Data Type	Numeric type (Integer)

E4990A Impedance Analyzer Help

Range	2 ~ 1601
Preset Value	201
Unit	-
Resolution	-

Query Response

{numeric} <newline> < ^END>

Examples

```
Dim Var as Long
Var= 2
Ana.WriteString ":SENS1:SWE:POIN " & Str(Var), True
Ana.WriteString ":SENS1:SWE:POIN?", True
Var=Ana.ReadNumber
```

Related Commands

[:SENS:SEGM:SWE:POIN](#)

Equivalent Softkey

Sweep Setup > **Points**

Instrument Setup > **Points**

COM Command Syntax (Internal Control Only)

SCPI.SENSE(Ch).SWEEP.POINTS

:SENS<Ch>:SWE:TIME

Type

Command/Query

Syntax

:SENSe<Ch>:SWEep:TIME <Value>

:SENSe<Ch>:SWEep:TIME?

Description

This command sets/gets the additional sweep time.

Variable

Parameter	Value
Description	Additional sweep time
Data Type	Numeric type (Real)

Range	0 ~ 2M
Preset Value	0
Unit	sec
Resolution	1m

Query Response

{numeric} <newline> < ^END>

Examples

```
Dim Var as Double
Var =0.1
Ana.WriteString ":SENS1:SWE:TIME " & Str(Var), True
Ana.WriteString ":SENS1:SWE:TIME?", True
Var=Ana.ReadNumber
```

Related Commands

[:SENS:SWE:PDEL](#)

[:SENS:SWE:DEL](#)

Equivalent Softkey

Sweep Setup > **Sweep Time**

COM Command Syntax (Internal Control Only)

SCPI.SENSE(Ch).SWEEP.TIME

:SENS<Ch>:SWE:TYPE

Type

Command/Query

Syntax

:SENSe<Ch>:SWEep:TYPE
{LINear|LOGarithmic|SEGment|POWER|BIAS|LBias}

:SENSe<Ch>:SWEep:TYPE?

Description

This command sets/gets the sweep type.

Variable

Parameter	Selection Option
Description	Sweep Type

Data Type	Character string type (String)
Range	LINear: Linear LOGarithmic: Logarithmic SEGMENT: Segment POWer: Power BIAS: DC Bias (Linear) LBIas: DC Bias (Log)
Preset Value	LINear

Query Response

{LIN|LOG|SEGM|POW|BIAS|LBI} <newline> < ^END>

Examples

```
Dim Var as String
Var= "LIN"
Ana.WriteString ":SENS1:SWE:TYPE " & Var, True
Ana.WriteString ":SENS1:SWE:TYPE?", True
Var=Ana.ReadString
```

Related Commands

[:SENS:SEGM:DATA](#)

Equivalent Softkey

Sweep Setup > **Sweep Type**

COM Command Syntax (Internal Control Only)

SCPI.SENSE(Ch).SWEEP.TYPE

SERVICE

:SERV:ACH:ACT

Type

Command/Query

Syntax

```
:SERVice:ACHannel:ACTive <Value>
:SERVice:ACHannel:ACTive?
```

Description

This command set/get active channel number.

Variable

Parameter	Value
-----------	-------

Description	Active channel number
Data Type	Long integer type (Long)
Range	1 to 4
Preset Value	1

Query Response

{ numeric } <newline> < ^END >

Examples

```
Dim Var as Long
Ana.WriteString ":SERV:ACH:ACT"& Str(Var), True
Ana.WriteString ":SERV:ACH:ACT?", True
Var=Ana.ReadString
```

Equivalent Softkey

No equivalent key is available on the front panel.

COM Command Syntax (Internal Control Only)

SCPI.SERVICE.ACHANNEL.ACTIVE

:SERV:ACH:COUN**Type**

Query

Syntax

:SERVice:ACHannel:COUNT?

Description

This command returns the number of channels.

Query Response

{ numeric } <newline> < ^END >

Examples

```
Dim Var as Long
Ana.WriteString ":SERV:ACH:COUN?", True
Var=Ana.ReadString
```

Equivalent Softkey

No equivalent key is available on the front panel.

COM Command Syntax (Internal Control Only)

SCPI.SERVICE.ACHANNEL.COUNT

E4990A Impedance Analyzer Help

:SERV:CHAN<Ch>:ATR:ACT

Type

Command/Query

Syntax

:SERVice:CHANnel<Ch>:ATRace:ACTive <Value>

:SERVice:CHANnel<Ch>:ATRace:ACTive?

Description

This command sets/gets active trace number.

Variable

Parameter	Value
Description	Active trace number
Data Type	Long integer type (Long)
Range	1 to 4
Preset Value	1

Query Response

{ numeric } <newline> < ^END >

Examples

```
Dim Var as Long
Ana.WriteString ":SERV:CHAN1:ATR:ACT"& Str(Var), True
Ana.WriteString ":SERV:CHAN1:ATR:ACT?", True
Var=Ana.ReadNumber
```

Equivalent Softkey

No equivalent key is available on the front panel.

COM Command Syntax (Internal Control Only)

SCPI.SERVICE.CHANNEL(Ch).ATRACE.ACTIVE

:SERV:CHAN<Ch>:ATR:COUN

Type

Query

Syntax

:SERVice:CHANnel<Ch>:ATRace:COUNT?

Description

This command returns the number of traces (one per channel).

Query Response

```
{ numeric } <newline> < ^END>
```

Examples

```
Dim Var as Long
Ana.WriteString ":SERV:CHAN1:ATR:COUN?", True
Var=Ana.ReadNumber
```

Equivalent Softkey

No equivalent key is available on the front panel.

COM Command Syntax (Internal Control Only)

```
SCPI.SERVICE.CHANNEL(Ch).ATRACE.COUNT
```

:SERV:CHAN<Ch>:CAL<Type>:LOAD**Type**

Query

Syntax

```
:SERVice:CHANnel<Ch>:CAL<Type>:LOAD?
```

Description

This command returns the number of data for correction table.
(<type>: User calibration=1, Fixture Compensation=2)

Query Response

```
{ numeric 1 }, ... , { numeric NOP×2 } <newline> < ^END>
{ numeric (n×2)-1 }: Value at N-th point (Primary)
{ numeric (n×2) }: Value at N-th point (Secondary)
```

Examples

```
Dim Var as Variant
Ana.WriteString ":SERV:CHAN1:CAL1:LOAD?", True
Var=Ana.ReadList
```

Equivalent Softkey

No equivalent key is available on the front panel.

COM Command Syntax (Internal Control Only)

```
SCPI.SERVICE.CHANNEL(Ch).CAL(Type).LOAD
```

:SERV:CHAN(Ch):CAL<Type>:OPEN**Type**

Query

Syntax

E4990A Impedance Analyzer Help

:SERVICE:CHANNEL<Ch>:CAL<Type>:OPEN?

Description

This command returns the number of data for correction table.
(<type>: User calibration=1, Fixture Compensation=2)

Query Response

```
{ numeric 1 }, ... , { numeric NOP×2 } <newline> < ^END>  
{ numeric (n×2)-1 }: Value at N-th point (Primary)  
{ numeric (n×2) }: Value at N-th point (Secondary)
```

Examples

```
Dim Var as Variant  
Ana.WriteString ":SERV:CHAN1:CAL1:OPEN?", True  
Var=Ana.ReadList
```

Equivalent Softkey

No equivalent key is available on the front panel.

COM Command Syntax (Internal Control Only)

```
SCPI.SERVICE.CHANNEL(Ch).CAL(Type).OPEN
```

:SERV:CHAN<Ch>:CAL<Type>:SHORT

Type

Query

Syntax

:SERVICE:CHANNEL<Ch>:CAL<Type>:SHORT?

Description

This command returns the number of data for correction table.
(<type>: User calibration=1, Fixture Compensation=2)

Query Response

```
{ numeric 1 }, ... , { numeric NOP×2 } <newline> < ^END>  
{ numeric (n×2)-1 }: Value at N-th point (Primary)  
{ numeric (n×2) }: Value at N-th point (Secondary)
```

Examples

```
Dim Var as Variant  
Ana.WriteString ":SERV:CHAN1:CAL1:SHORT?", True  
Var=Ana.ReadList
```

Equivalent Softkey

No equivalent key is available on the front panel.

COM Command Syntax (Internal Control Only)

SCPI.SERVICE.CHANNEL(Ch).CAL(Type).SHORT

:SERV:CHAN:DISP:ANN:XAX:MODE:BIAS

Type

Command/Query

Syntax

```
:SERVice:CHANnel<Ch>:DISPlay:ANNotation:XAXis:MODE:BIAS
{SSTop|CSPan}
```

```
:SERVice:CHANnel<Ch>:DISPlay:ANNotation:XAXis:MODE:BIAS?
```

Description

This command sets/gets x-axis annotation mode (Start/Stop or Center/Span).

Variable

Parameter	Selection Option
Description	X-axis annotation mode
Data Type	Character string type (String)
Range	SSTop: Start/Stop CSPan: Center/Span
Preset Value	SSTop

Query Response

```
{SST|CSP}<newline><^END>
```

Examples

```
Dim Var as String
Var= "SSTop"
Ana.WriteString ":SERV:CHAN1:DISP:ANN:XAX:MODE:BIAS " & Var, True
Ana.WriteString ":SERV:CHAN1:DISP:ANN:XAX:MODE:BIAS?", True
Var=Ana.ReadString
```

Equivalent Softkey

No equivalent key is available on the front panel.

COM Command Syntax (Internal Control Only)

```
SCPI.SERVICE.CHANNEL(Ch).DISPLAY.ANNOTATION.XAXIS.MODE.BIAS
```

:SERV:CHAN<Ch>:DISP:ANN:XAX:MODE:FREQ

E4990A Impedance Analyzer Help

Type

Command/Query

Syntax

:SERVice:CHANnel<Ch>:DISPlay:ANNotation:XAxis:MODE:FREQuency
{SSTop|CSPan}

:SERVice:CHANnel<Ch>:DISPlay:ANNotation:XAxis:MODE:FREQuency?

Description

This command sets/gets x-axis annotation mode (Start/Stop or Center/Span).

Variable

Parameter	Selection Option
Description	X-axis annotation mode
Data Type	Character string type (String)
Range	SSTop: Start/Stop CSPan: Center/Span
Preset Value	SSTop

Query Response

{SST|CSP}<newline><^END>

Examples

```
Dim Var as String
Var= "SSTop"
Ana.WriteString ":SERV:CHAN1:DISP:ANN:XAAX:MODE:FREQ " & Var, True
Ana.WriteString ":SERV:CHAN1:DISP:ANN:XAAX:MODE:FREQ?", True
Var=Ana.ReadString
```

Equivalent Softkey

No equivalent key is available on the front panel.

COM Command Syntax (Internal Control Only)

SCPI.SERVICE.CHANNEL(Ch).DISPLAY.ANNOTATION.XAXIS.MODE.FREQUENCY

:SERV:CHAN:DISP:ANN:XAAX:MODE:POW

Type

Command/Query

Syntax

```
:SERVICE:CHANNEL<Ch>:DISPLAY:ANNOTATION:XAXIS:MODE:POWER
{SSTop|CSPan}
```

```
:SERVICE:CHANNEL<Ch>:DISPLAY:ANNOTATION:XAXIS:MODE:POWER?
```

Description

This command sets/gets x-axis annotation mode (Start/Stop or Center/Span).

Variable

Parameter	Selection Option
Description	X-axis annotation mode
Data Type	Character string type (String)
Range	SSTop: Start/Stop CSPan: Center/Span
Preset Value	SSTop

Query Response

```
{SST|CSP}<newline>< ^END>
```

Examples

```
Dim Var as String
Var= "SSTop"
Ana.WriteString ":SERV:CHAN1:DISP:ANN:XAX:MODE:POW " & Var, True
Ana.WriteString ":SERV:CHAN1:DISP:ANN:XAX:MODE:POW?", True
Var=Ana.ReadString
```

Equivalent Softkey

No equivalent key is available on the front panel.

COM Command Syntax (Internal Control Only)

```
SCPI.SERVICE.CHANNEL(Ch).DISPLAY.ANNOTATION.XAXIS.MODE.POWER
```

:SERV:CHAN<Ch>:SEGM:DATA**Type**

Query

Syntax

```
:SERVICE:CHANNEL<Ch>:SEGMENT:DATA?
```

Description

E4990A Impedance Analyzer Help

This command returns the number of data for the segment table.

Query Response

{numeric} <newline> < ^END>

Examples

```
Dim Var as Long
Ana.WriteString ":SERV:CHAN1:SEGM:DATA?", True
Var=Ana.ReadNumber
```

Equivalent Softkey

No equivalent key is available on the front panel.

COM Command Syntax (Internal Control Only)

SCPI.SERVICE.CHANNEL(Ch).SEGMENT.DATA

:SERV:CHAN:SWE:ALC:AC:STAT

Type

Query

Syntax

:SERVice:CHANnel<Ch>:SWEep:ALC:AC:STATe?

Description

This command returns the current ALC status for each point.

Query Response

{numeric 1}, ... , {numeric (3×NOP)} <newline> < ^END>

{numeric (n×3)-2}: Status [-1=No ALC performed, 0=Leveled, 1=Resolution Limit, 2=Vs Limit, 3=Iteration Limit]

{numeric (n×3)-1}: Number of iteration

{numeric (n×3)}: Actual voltage

Examples

```
Dim Var as Variant
Ana.WriteString ":SERV:CHAN1:SWE:ALC:AC:STAT?", True
Var=Ana.ReadList
```

Equivalent Softkey

No equivalent key is available on the front panel.

COM Command Syntax (Internal Control Only)

SCPI.SERVICE.CHANNEL(Ch).SWEEP.ALC.AC.STATE

:SERV:CHAN<Ch>:SWE:POIN

Type

Query

Syntax

```
:SERVICE:CHANNEL<Ch>:SWEEP:POINTS?
```

Description

This command gets current number of point for active sweep type (SENS:SWE:POIN? or SENS:SEG:SWE:POIN?).

Query Response

```
{numeric} <newline> <^END>
```

Examples

```
Dim Var as Long
Ana.WriteString ":SERV:CHAN1:SWE:POIN?", True
Var=Ana.ReadNumber
```

Equivalent Softkey

No equivalent key is available on the front panel.

COM Command Syntax (Internal Control Only)

```
SCPI.SERVICE.CHANNEL(Ch).SWEEP.POINTS
```

:SERV:CHAN<Ch>:TRAC<Tr>:AMRK:ACT

Type

Command/Query

Syntax

```
:SERVICE:CHANNEL<Ch>:TRACE<Tr>:AMRKer:ACTIVE <Value>
```

```
:SERVICE:CHANNEL<Ch>:TRACE<Tr>:AMRKer:ACTIVE?
```

Description

This command sets/gets active marker number (one per trace). 0 is returned if no marker is activated.

Variable

Parameter	Long
Description	Active marker number of selected trace in selected channel
Data Type	Long integer type (Long)
Range	0 to 10
Preset	0

Value	
--------------	--

Query Response

{ numeric } <newline> < ^END>

0: No marker

1-10: Active marker number

Examples

Dim Var as Long

Var= 1

Ana.WriteString ":SERV:CHAN1:TRAC1:AmRK:ACT " & Str(Var), True

Ana.WriteString ":SERV:CHAN1:TRAC1:AMRK:ACT?", True

Var=Ana.ReadNumber

Related Commands

[:CALC:MARK:ACT](#)

Equivalent Softkey

Marker > {Marker n}

Marker > Ref Maker

COM Command Syntax (Internal Control Only)

SCPI.SERVICE.CHANNEL(Ch).TRACE(Tr).AMRKER.ACTIVE

:SERV:CHAN<Ch>:TRAC<Tr>:LIM:DATA

Type

Query

Syntax

:SERVice:CHANnel<Ch>:TRACe<Tr>:LIMit:DATA?

Description

This command gets the number of limit data.

Variable

Parameter	Long
Description	Number of array elements
Data Type	Long integer type (Long)
Range	1 to 501

Preset Value	1
---------------------	---

Query Response

{ numeric} <newline> < ^END>

Examples

```
Dim Var as Long
Var= 1
Ana.WriteString ":SERV:CHAN1:TRAC1:LIM:DATA?", True
Var=Ana.ReadNumber
```

Equivalent Softkey

No equivalent key is available on the front panel.

COM Command Syntax (Internal Control Only)

SCPI.SERVICE.CHANNEL(Ch).TRACE(Tr).LIMIT.DATA

:SERV:CHAN<Ch>:TRAC<Tr>:MEMV**Type**

Command/Query

Syntax

:SERVice:CHANnel<Ch>:TRACe<Tr>:MEMValid {ON|OFF|1|0}

:SERVice:CHANnel<Ch>:TRACe<Tr>:MEMValid?

Description

This command sets/gets the memory trace data valid flag. Always set to 0 after preset.

Variable

Parameter	Selection Option
Description	Memory trace data
Data Type	Boolean type (Boolean)
Range	ON OFF 1 0
Preset Value	OFF

Query Response

E4990A Impedance Analyzer Help

{1|0} <newline> < ^END>

Examples

```
Dim Var as Integer
Ana.WriteString ":SERV:CHAN1:TRAC1:MEMV OFF", True
Ana.WriteString ":SERV:CHAN1:TRAC1:MEMV?", True
Var=Ana.ReadNumber
```

Equivalent Softkey

No equivalent key is available on the front panel.

COM Command Syntax (Internal Control Only)

```
SCPI.SERVICE.CHANNEL(Ch).TRACE(Tr).MEMVALID
```

:SERV:LOGG:CLE

Type

Command

Syntax

```
:SERVice:LOGGing:CLEar
```

Description

This command clear all [log files](#) about Event, Power on test, Mech sw, Overload, FW close, Recovery. (no action if simulator mode)

Examples

```
Ana.WriteString ":SERV:LOGG:CLE", True
```

Equivalent Softkey

No equivalent key is available on the front panel.

COM Command Syntax (Internal Control Only)

```
SCPI.SERVICE.LOGGING.CLEAR
```

:SERV:SREV

Type

Query

Syntax

```
:SERVice:SREVision?
```

Description

This command gets system/spec revision.

Variable

Parameter	Long
Description	0: applying current system specifications
Data Type	Long integer type (Long)

Query Response

```
{ numeric} <newline> < ^END>
```

Examples

```
Dim Var as Long
Ana.WriteString ":SERV:SREV?", True
Var=Ana.ReadNumber
```

Equivalent Softkey

No equivalent key is available on the front panel.

COM Command Syntax (Internal Control Only)

```
SCPI.SERVICE.SREVISION
```

:SERV:SWE:FREQ:EXP

Type

Command

Syntax

```
:SERVICE:SWEep:FREQuency:EXPand
```

Description

This command expands the frequency range for adjustment. The expand mode will automatically be disabled on the next restart.

Examples

```
Ana.WriteString ":SERV:SWE:FREQ:EXP", True
```

Equivalent Softkey

No equivalent key is available on the front panel.

COM Command Syntax (Internal Control Only)

```
SCPI.SERVICE.SWEEP.FREQUENCY.EXPAND
```

:SERV:SWE:FREQ:MAX

Type

Query

Syntax

```
:SERVICE:SWEep:FREQuency:MAXimum?
```

Description

This command gets the maximum frequency.

Variable

Parameter	Double
Description	Upper limit of measurement frequency
Data Type	Double precision floating point type

E4990A Impedance Analyzer Help

Query Response

{numeric} <newline>< ^END>

Examples

```
Dim Var as Double
Ana.WriteString ":SERV:SWE:FREQ:MAX?", True
Var=Ana.ReadNumber
```

Equivalent Softkey

No equivalent key is available on the front panel.

COM Command Syntax (Internal Control Only)

SCPI.SERVICE.SWEEP.FREQUENCY.MAXIMUM

:SERV:SWE:FREQ:MIN

Type

Query

Syntax

:SERVice: SWEep: FREQuency: MINimum?

Description

This command gets the minimum frequency.

Variable

Parameter	Double
Description	Lower limit of measurement frequency
Data Type	Double precision floating point type

Query Response

{numeric} <newline>< ^END>

Examples

```
Dim Var as Double
Ana.WriteString ":SERV:SWE:FREQ:MIN?", True
Var=Ana.ReadNumber
```

Equivalent Softkey

No equivalent key is available on the front panel.

COM Command Syntax (Internal Control Only)

SCPI.SERVICE.SWEEP.FREQUENCY.MINIMUM

:SERV:SWE:POIN**Type**

Query

Syntax

:SERVice: SWEep: POINTs?

Description

This command gets the number of points.

Variable

Parameter	Long
Description	Number of points
Data Type	Long integer type (Long)

Query Response

{ numeric } <newline> < ^END >

Examples

```
Dim Var as Long
Ana.WriteString ":SERV:SWE:POIN?", True
Var=Ana.ReadNumber
```

Equivalent Softkey

No equivalent key is available on the front panel.

COM Command Syntax (Internal Control Only)

SCPI.SERVICE.SWEEP.POINTS

:SERV:SYST:STOR:REV**Type**

Query

Syntax

:SERVice: SYSTem: STORage: REVision?

Description

This command storage image revision. Return 'RYxxx' for RY100, RY110 etc. Return 'UNKNOWN' if os image not identified.

Variable

Parameter	Value
------------------	-------

E4990A Impedance Analyzer Help

Description	Revision of image stored
Data Type	Character string type (String)
Range	254 Chars

Query Response

{ 254 chars } <newline> < ^END >

Examples

```
Dim Var as String
Ana.WriteString ":SERV:SYST:STOR:REV?", True
Var=Ana.ReadString
```

Equivalent Softkey

No equivalent key is available on the front panel.

COM Command Syntax (Internal Control Only)

SCPI.SERVICE.SYSTEM.STORAGE.REVISION

SOURCE

:SOUR<Ch>:ALC

Type

Command/Query

Syntax

:SOURce<Ch>:ALC[:STATe] {ON|OFF|1|0}

:SOURce<Ch>:ALC[:STATe]?

Description

This command turn on/off the ALC function.

Variable

Parameter	Selection Option
Description	ALC On/Off status
Data Type	Boolean type (Boolean)
Range	ON OFF 1 0
Preset Value	OFF

Query Response

```
{1|0}<newline><^END>
```

Examples

```
Dim Var as Integer
Ana.WriteString ":SOUR1:ALC ON", True
Ana.WriteString ":SOUR1:ALC?", True
Var=Ana.ReadNumber
```

Related Commands

[:SOUR:ALC:COUN](#)

[:SOUR:ALC:TOL](#)

Equivalent Softkey

Sweep Setup > **OSC Level** > **ALC** > **ALC**

COM Command Syntax (Internal Control Only)

```
SCPI.SOURCE(Ch).ALC.STATE
```

```
:SOUR<Ch>:ALC:COUN
```

Type

Command/Query

Syntax

```
:SOURce<Ch>:ALC:COUNT <Value>
```

```
:SOURce<Ch>:ALC:COUNT?
```

Description

This command sets/gets the AC ALC maximum iteration count.

Variable

Parameter	Value
Description	Maximum iteration count
Data Type	Numeric type (Integer)
Range	2 ~ 10
Preset Value	10
Unit	-
Resolution	-

Query Response

E4990A Impedance Analyzer Help

{ numeric } <newline> < ^END>

Examples

```
Dim Var as Long
Var= 4
Ana.WriteString ":SOUR1:ALC:COUN " & Str(Var), True
Ana.WriteString ":SOUR1:ALC:COUN?", True
Var=Ana.ReadNumber
```

Related Commands

[:SOUR:ALC](#)

Equivalent Softkey

Sweep Setup > **OSC Level** > **ALC** > **Max Iteration**

COM Command Syntax (Internal Control Only)

SCPI.SOURCE(Ch).ALC.COUNT

:SOUR<Ch>:ALC:TOL

Type

Command/Query

Syntax

:SOURce<Ch>:ALC:TOLerance <Value>

:SOURce<Ch>:ALC:TOLerance?

Description

This command sets/gets the ALC target %.

Variable

Parameter	Value
Description	Tolerance value
Data Type	Numeric type (Real)
Range	0.05 ~ 10
Preset Value	5
Unit	%
Resolution	-

Query Response

{ numeric } <newline> < ^END>

Examples

```
Dim Var as Double
Var= 0.1
Ana.WriteString ":SOUR1:ALC:TOL " & Str(Var), True
Ana.WriteString ":SOUR1:ALC:TOL?", True
Var=Ana.ReadNumber
```

Related Commands

[:SOUR:ALC](#)

[:SOUR:ALC:COUN](#)

Equivalent Softkey

Sweep Setup > **OSC Level** > **ALC** > **Target %**

COM Command Syntax (Internal Control Only)

SCPI.SOURCE(Ch).ALC.TOLERANCE

:SOUR<Ch>:BIAS:ALC

Type

Command/Query

Syntax

:SOURce<Ch>:BIAS:ALC[:STATe] {ON|OFF|1|0}

:SOURce<Ch>:BIAS:ALC[:STATe]?

Description

This command turn on/off the DC bias constant mode.

Variable

Parameter	Selection Option
Description	DC bias constant mode On/Off status
Data Type	Boolean type (Boolean)
Range	ON OFF 1 0
Preset Value	OFF

Query Response

{1|0} <newline> < ^END>

Examples

```
Dim Var as Integer
Ana.WriteString ":SOUR1:BIAS:ALC ON", True
Ana.WriteString ":SOUR1:BIAS:ALC?", True
Var=Ana.ReadNumber
```

E4990A Impedance Analyzer Help

Related Commands

[:SOUR:BIAS:MODE](#)

[:SOUR:BIAS:STAT](#)

Equivalent Softkey

Sweep Setup > DC Bias > Constant Mode

COM Command Syntax (Internal Control Only)

SCPI.SOURCE(Ch).BIAS.ALC.STATE

:SOUR:BIAS:CURR:AMPL

Type

Command/Query

Syntax

:SOURce<Ch>:BIAS:CURRent[:LEVel][:IMMEDIATE]:AMPLitude <Value>

:SOURce<Ch>:BIAS:CURRent[:LEVel][:IMMEDIATE]:AMPLitude?

Description

This command sets/gets the current level of DC Bias output.

Variable

Parameter	Value
Description	Current level
Data Type	Numeric type (Real)
Range	-100m ~ 100m
Preset Value	0
Unit	A
Resolution	40 μ

Query Response

{numeric} <newline> < ^END>

Examples

Dim Var as Double

Var= 0.01

Ana.WriteString ":SOUR1:BIAS:CURR:AMPL " & Str(Var), True

Ana.WriteString ":SOUR1:BIAS:CURR:AMPL?", True

Var=Ana.ReadNumber

Related Commands[:SOUR:BIAS:MODE](#)**Equivalent Softkey****Sweep Setup > DC Bias > Current Level****COM Command Syntax (Internal Control Only)**

SCPI.SOURCE(Ch).BIAS.CURRENT.LEVEL.IMMEDIATE.AMPLITUDE

:SOUR<Ch>:BIAS:CURR:CENT**Type**

Command/Query

Syntax

:SOURce<Ch>:BIAS:CURRent:CENTer <Value>

:SOURce<Ch>:BIAS:CURRent:CENTer?

Description

This command sets/gets the center of bias current value in DC bias sweep.

Variable

Parameter	Value
Description	Center value
Data Type	Numeric type (Real)
Range	-100m ~ 100m
Preset Value	0
Unit	A
Resolution	20 μ

Query Response

{ numeric } <newline> < ^END >

Examples

```
Dim Var as Double
Var= 0.3
Ana.WriteString ":SOUR1:BIAS:CURR:CENT " & Str(Var), True
Ana.WriteString ":SOUR1:BIAS:CURR:CENT?", True
Var=Ana.ReadNumber
```

Related Commands

E4990A Impedance Analyzer Help

[:SOUR:BIAS:CURR:SPAN](#)

[:SOUR:BIAS:MODE](#)

Equivalent Softkey

Center (in DC Bias current sweep)

COM Command Syntax (Internal Control Only)

SCPI.SOURCE(Ch).BIAS.CURRENT.CENTER

:SOUR<Ch>:BIAS:CURR:SPAN

Type

Command/Query

Syntax

:SOURce<Ch>:BIAS:CURRent:SPAN <Value>

:SOURce<Ch>:BIAS:CURRent:SPAN?

Description

This command sets/gets the span of bias current value in DC bias sweep.

Variable

Parameter	Value
Description	Span value
Data Type	Numeric type (Real)
Range	0 ~ 200m
Preset Value	0
Unit	A
Resolution	40 μ

Query Response

{ numeric } <newline> < ^END >

Examples

```
Dim Var as Double
Var= 0.1
Ana.WriteString ":SOUR1:BIAS:CURR:SPAN " & Str(Var), True
Ana.WriteString ":SOUR1:BIAS:CURR:SPAN?", True
Var=Ana.ReadNumber
```

Related Commands

[:SOUR:BIAS:CURR:CENT](#)

[:SOUR:BIAS:MODE](#)

Equivalent Softkey

Span (in DC Bias current sweep)

COM Command Syntax (Internal Control Only)

SCPI.SOURCE(Ch).BIAS.CURRENT.SPAN

:SOUR<Ch>:BIAS:CURR:STAR

Type

Command/Query

Syntax

:SOURce<Ch>:BIAS:CURRent:STARt <Value>

:SOURce<Ch>:BIAS:CURRent:STARt?

Description

This command sets/gets the start of bias current value in DC bias sweep.

Variable

Parameter	Value
Description	start value
Data Type	Numeric type (Real)
Range	-100m ~ 100m
Preset Value	0
Unit	A
Resolution	40μ

Query Response

{ numeric } <newline> < ^END >

Examples

Dim Var as Double

Var= -0.1

Ana.WriteString ":SOUR1:BIAS:CURR:STAR " & Str(Var), True

Ana.WriteString ":SOUR1:BIAS:CURR:STAR?", True

Var=Ana.ReadNumber

Related Commands

E4990A Impedance Analyzer Help

[:SOUR:BIAS:CURR:STOP](#)

[:SOUR:BIAS:CURR:STAR](#)

Equivalent Softkey

Start (in DC Bias current sweep)

COM Command Syntax (Internal Control Only)

SCPI.SOURCE(Ch).BIAS.CURRENT.START

:SOUR<Ch>:BIAS:CURR:STOP

Type

Command/Query

Syntax

:SOURce<Ch>:BIAS:CURRent:STOP <Value>

:SOURce<Ch>:BIAS:CURRent:STOP?

Description

This command sets/gets the stop of bias current value in DC bias sweep.

Variable

Parameter	Value
Description	Stop value
Data Type	Numeric type (Real)
Range	-100m ~ 100m
Preset Value	0
Unit	A
Resolution	40μ

Query Response

{ numeric } <newline> < ^END >

Examples

```
Dim Var as Double
Var= 0.1
Ana.WriteString ":SOUR1:BIAS:CURR:STOP " & Str(Var), True
Ana.WriteString ":SOUR1:BIAS:CURR:STOP?", True
Var=Ana.ReadNumber
```

Related Commands

[:SOUR:BIAS:CURR:STAR](#)

[:SOUR:BIAS:MODE](#)

Equivalent Softkey

Stop (in DC Bias current sweep)

COM Command Syntax (Internal Control Only)

SCPI.SOURCE(Ch).BIAS.CURRENT.STOP

:SOUR<Ch>:BIAS:DEL

Type

Command/Query

Syntax

:SOURce<Ch>:BIAS:DELay <Value>

:SOURce<Ch>:BIAS:DELay?

Description

This command sets/gets wait time after DC bias setup

Variable

Parameter	Value
Description	Delay
Data Type	Numeric type (Real)
Range	0 ~ 30
Preset Value	0
Unit	s
Resolution	1m

Query Response

{ numeric } <newline> < ^END >

Examples

Dim Var as Double

Var= 0.01

Ana.WriteString ":SOUR1:BIAS:DEL " & Str(Var), True

Ana.WriteString ":SOUR1:BIAS:DEL?", True

Var=Ana.ReadNumber

Related Commands

[:SOUR:BIAS:STAT](#)

Equivalent Softkey

Sweep Setup > **DC Bias** > **DC Bias Delay**

COM Command Syntax (Internal Control Only)

SCPI.SOURCE(Ch).BIAS.DELAY

:SOUR<Ch>:BIAS:HOLD

Type

Command/Query

Syntax

:SOURce<Ch>:BIAS:HOLD[:OUTPut] {ON|OFF|1|0}

:SOURce<Ch>:BIAS:HOLD[:OUTPut]?

Description

This command sets/gets bias output when sweep is held. (one per instrument)

Variable

Parameter	Selection Option
Description	bias output hold on/off status
Data Type	Boolean type (Boolean)
Range	ON OFF 1 0
Preset Value	ON

Query Response

{1|0}<newline><^END>

Examples

```
Dim Var as Integer
Ana.WriteString ":SOUR1:BIAS:HOLD ON", True
Ana.WriteString ":SOUR1:BIAS:HOLD?", True
Var=Ana.ReadNumber
```

Related Commands

[:SOUR:BIAS:STAT](#)

Equivalent Softkey

System > **Meas Setup** > **DC Output@Hold**

COM Command Syntax (Internal Control Only)

SCPI.SOURCE(Ch).BIAS.HOLD.OUTPUT

:SOUR<Ch>:BIAS:MODE**Type**

Command/Query

Syntax

:SOURce<Ch>:BIAS:MODE {VOLTage|CURRent}

:SOURce<Ch>:BIAS:MODE?

Description

This command sets/gets the DC bias mode.

Variable

Parameter	Selection Option
Description	DC Bias Output Mode
Data Type	Character string type (String)
Range	VOLTage CURRent
Preset Value	VOLTage

Query Response

{VOLT|CURR}<newline><^END>

Examples

```
Dim Var as String
Var= "VOLT"
Ana.WriteString ":SOUR1:BIAS:MODE " & Var, True
Ana.WriteString ":SOUR1:BIAS:MODE?", True
Var=Ana.ReadString
```

Related Commands[:SOUR:BIAS:CURR:AMPL](#)[:SOUR:BIAS:VOLT](#)**Equivalent Softkey****Sweep Setup > DC Bias > DC Bias Mode****COM Command Syntax (Internal Control Only)**

SCPI.SOURCE(Ch).BIAS.MODE

:SOUR<Ch>:BIAS:RANG**Type**

Command/Query

Syntax

E4990A Impedance Analyzer Help

:SOURce<Ch>:BIAS:RANGe {M1|M10|M100}

:SOURce<Ch>:BIAS:RANGe?

Description

This command sets/gets the DC Bias range.

Variable

Parameter	Selection Option
Description	DC Bias range
Data Type	Character string type (String)
Range	M1: 1mA M10: 10mA M100: 100mA
Preset Value	M1

Query Response

{M1|M10|M100} <newline> < ^END >

Examples

```
Dim Var as String
Var= "M10"
Ana.WriteString ":SOUR1:BIAS:RANG " & Var, True
Ana.WriteString ":SOUR1:BIAS:RANG?", True
Var=Ana.ReadString
```

Related Commands

[:SOUR:BIAS:STAT](#)

Equivalent Softkey

Sweep Setup > **DC Bias** > **Meas Range**

COM Command Syntax (Internal Control Only)

SCPI.SOURCE(Ch).BIAS.RANGE

:SOUR:BIAS:STAT

Type

Command/Query

Syntax

:SOURce:BIAS:STATe {ON|OFF|1|0}

:SOURce:BIAS:STATe?

Description

This command sets/gets the DC Bias Output State. This setting is applied for all channels and traces. The DC bias is automatically turned off after recall the status file.

Variable

Parameter	Selection Option
Description	DC bias output On/off state
Data Type	Boolean type (Boolean)
Range	ON OFF 1 0
Preset Value	OFF

Query Response

```
{1|0}<newline><^END>
```

Examples

```
Dim Var as Integer
Ana.WriteString ":SOUR:BIAS:STAT ON", True
Ana.WriteString ":SOUR:BIAS:STAT?", True
Var=Ana.ReadNumber
```

Related Commands

[:SOUR:BIAS:MODE](#)

Equivalent Softkey

Sweep Setup > DC Bias > DC Bias State

Sweep Setup > DC Bias State

COM Command Syntax (Internal Control Only)

```
SCPI.SOURCE.BIAS.STATE
```

```
:SOUR:BIAS:VOLT
```

Type

Command/Query

Syntax

```
:SOURce<Ch>:BIAS:VOLTage[:LEVel][:IMMEDIATE][:AMPLitude] <Value>
```

```
:SOURce<Ch>:BIAS:VOLTage[:LEVel][:IMMEDIATE][:AMPLitude]?
```

Description

This command sets/gets the voltage level of DC Bias output.

Variable

E4990A Impedance Analyzer Help

Parameter	Value
Description	Voltage level
Data Type	Numeric type (Real)
Range	-40 ~ 40
Preset Value	0
Unit	V
Resolution	1m

Query Response

{ numeric } <newline> < ^END >

Examples

```
Dim Var as Double
Var = 0.5
Ana.WriteString ":SOUR1:BIAS:VOLT " & Str(Var), True
Ana.WriteString ":SOUR1:BIAS:VOLT?", True
Var = Ana.ReadNumber
```

Related Commands

[:SOUR:BIAS:MODE](#)

Equivalent Softkey

Sweep Setup > DC Bias > Voltage Level

COM Command Syntax (Internal Control Only)

SCPI.SOURCE(Ch).BIAS.VOLTAGE.LEVEL.IMMEDIATE.AMPLITUDE

:SOUR<Ch>:BIAS:VOLT:CENT

Type

Command/Query

Syntax

:SOURce<Ch>:BIAS:VOLTage:CENTer <Value>

:SOURce<Ch>:BIAS:VOLTage:CENTer?

Description

This command sets/gets the center of bias voltage value in DC bias sweep.

Variable

Parameter	Value
Description	Center value
Data Type	Numeric type (Real)
Range	-40 ~ 40
Preset Value	0
Unit	V
Resolution	500 μ

Query Response

{ numeric } <newline> < ^END >

Examples

```
Dim Var as Double
Var= 10
Ana.WriteString ":SOUR1:BIAS:VOLT:CENT " & Str(Var), True
Ana.WriteString ":SOUR1:BIAS:VOLT:CENT?", True
Var=Ana.ReadNumber
```

Related Commands

[:SOUR:BIAS:VOLT:SPAN](#)

[:SOUR:BIAS:MODE](#)

Equivalent Softkey

Center (in DC Bias voltage sweep)

COM Command Syntax (Internal Control Only)

SCPI.SOURCE(Ch).BIAS.VOLTAGE.CENTER

:SOUR:BIAS:VOLT:LIM:MAX

Type

Command/Query

Syntax

:SOURce:BIAS:VOLTage:LIMit:MAXimum <Value>

:SOURce:BIAS:VOLTage:LIMit:MAXimum?

Description

This command sets/gets the bias limit maximum. This setting is applied for all channels and traces.

E4990A Impedance Analyzer Help

Variable

Parameter	Value
Description	Maximum limit
Data Type	Numeric type (Real)
Range	-40 ~ 40
Preset Value	40
Unit	V
Resolution	1m

Query Response

{ numeric } <newline> < ^END >

Examples

```
Dim Var as Double
Var= 30
Ana.WriteString ":SOUR:BIAS:VOLT:LIM:MAX " & Str(Var), True
Ana.WriteString ":SOUR:BIAS:VOLT:LIM:MAX?", True
Var=Ana.ReadNumber
```

Related Commands

[:SOUR:BIAS:VOLT:LIM:MIN](#)

Equivalent Softkey

Sweep Setup > **DC Bias** > **Max Limit Voltage**

COM Command Syntax (Internal Control Only)

SCPI.SOURCE.BIAS.VOLTAGE.LIMIT.MAXIMUM

:SOUR<Ch>:BIAS:VOLT:LIM:MIN

Type

Command/Query

Syntax

:SOURce<Ch>:BIAS:VOLTage:LIMit:MINimum <Value>

:SOURce<Ch>:BIAS:VOLTage:LIMit:MINimum?

Description

This command sets/gets the bias limit minimum. This setting is applied for all channels and traces.

Variable

Parameter	Value
Description	Minimum limit
Data Type	Numeric type (Real)
Range	-40 ~ 40
Preset Value	-40
Unit	V
Resolution	1m

Query Response

```
{ numeric } <newline> < ^END >
```

Examples

```
Dim Var as Double
Var= -20
Ana.WriteString ":SOUR:BIAS:VOLT:LIM:MIN " & Str(Var), True
Ana.WriteString ":SOUR:BIAS:VOLT:LIM:MIN?", True
Var=Ana.ReadNumber
```

Related Commands

[:SOUR:BIAS:VOLT:LIM:MAX](#)

Equivalent Softkey

Sweep Setup > DC Bias > Min Limit Voltage

COM Command Syntax (Internal Control Only)

```
SCPI.SOURCE.BIAS.VOLTAGE.LIMIT.MINIMUM
```

```
:SOUR<Ch>:BIAS:VOLT:SPAN
```

Type

Command/Query

Syntax

```
:SOURce<Ch>:BIAS:VOLTage:SPAN <Value>
```

```
:SOURce<Ch>:BIAS:VOLTage:SPAN?
```

Description

This command sets/gets the span of bias voltage value in DC bias sweep.

Variable

E4990A Impedance Analyzer Help

Parameter	Value
Description	Span value
Data Type	Numeric type (Real)
Range	0 ~ 80
Preset Value	0
Unit	V
Resolution	1m

Query Response

{ numeric } <newline> < ^END >

Examples

```
Dim Var as Double
Var= 20
Ana.WriteString ":SOUR1:BIAS:VOLT:SPAN " & Str(Var), True
Ana.WriteString ":SOUR1:BIAS:VOLT:SPAN?", True
Var=Ana.ReadNumber
```

Related Commands

[:SOUR:BIAS:VOLT:CENT](#)

[:SOUR:BIAS:MODE](#)

Equivalent Softkey

Span (in DC Bias voltage sweep)

COM Command Syntax (Internal Control Only)

SCPI.SOURCE(Ch).BIAS.VOLTAGE.SPAN

:SOUR<Ch>:BIAS:VOLT:STAR

Type

Command/Query

Syntax

:SOURce<Ch>:BIAS:VOLTage:STARt <Value>

:SOURce<Ch>:BIAS:VOLTage:STARt?

Description

This command sets/gets the start of bias voltage value in DC bias sweep.

Variable

Parameter	Value
Description	Start value
Data Type	Numeric type (Real)
Range	-40 ~ 40
Preset Value	0
Unit	V
Resolution	1m

Query Response

```
{ numeric } <newline> < ^END >
```

Examples

```
Dim Var as Double
Var= 0
Ana.WriteString ":SOUR1:BIAS:VOLT:STAR " & Str(Var), True
Ana.WriteString ":SOUR1:BIAS:VOLT:STAR?", True
Var=Ana.ReadNumber
```

Related Commands

[:SOUR:BIAS:VOLT:STOP](#)

[:SOUR:BIAS:MODE](#)

Equivalent Softkey

Start (in DC Bias voltage sweep)

COM Command Syntax (Internal Control Only)

```
SCPI.SOURCE(Ch).BIAS.VOLTAGE.START
```

```
:SOUR<Ch>:BIAS:VOLT:STOP
```

Type

Command/Query

Syntax

```
:SOURce<Ch>:BIAS:VOLTage:STOP <Value>
```

```
:SOURce<Ch>:BIAS:VOLTage:STOP?
```

Description

This command sets/gets the stop of bias voltage value in DC bias sweep.

Variable

E4990A Impedance Analyzer Help

Parameter	Value
Description	Stop value
Data Type	Numeric type (Real)
Range	-40 ~ 40
Preset Value	0
Unit	V
Resolution	1m

Query Response

{ numeric } <newline> < ^END >

Examples

```
Dim Var as Double
Var= 10
Ana.WriteString ":SOUR1:BIAS:VOLT:STOP " & Str(Var), True
Ana.WriteString ":SOUR1:BIAS:VOLT:STOP?", True
Var=Ana.ReadNumber
```

Related Commands

[:SOUR:BIAS:VOLT:STAR](#)

[:SOUR:BIAS:MODE](#)

Equivalent Softkey

Stop (in DC Bias voltage sweep)

COM Command Syntax (Internal Control Only)

SCPI.SOURCE(Ch).BIAS.VOLTAGE.STOP

:SOUR<Ch>:CURR

Type

Command/Query

Syntax

:SOURce<Ch>:CURRent[:LEVel][:IMMediate][:AMPLitude] <Value>

:SOURce<Ch>:CURRent[:LEVel][:IMMediate][:AMPLitude]?

Description

This command sets/gets the source current level.

Variable

Parameter	Value
Description	Current level
Data Type	Numeric type (Real)
Range	200 μ ~ 20m
Preset Value	20m
Unit	A
Resolution	20 μ

Query Response

{ numeric } < newline > < ^END >

Examples

```
Dim Var as Double
Var= 0.01
Ana.WriteString ":SOUR1:CURR " & Str(Var), True
Ana.WriteString ":SOUR1:CURR?", True
Var=Ana.ReadNumber
```

Related Commands

[:SOUR:MODE](#)

Equivalent Softkey

Sweep Setup > OSC Level > Current Level

COM Command Syntax (Internal Control Only)

SCPI.SOURCE(Ch).CURRENT.LEVEL.IMMEDIATE.AMPLITUDE

:SOUR<Ch>:CURR:CENT

Type

Command/Query

Syntax

:SOURce<Ch>:CURRent:CENTer <Value>

:SOURce<Ch>:CURRent:CENTer?

Description

This command sets/gets the center of current value in OSC level sweep.

Variable

E4990A Impedance Analyzer Help

Parameter	Value
Description	Center value
Data Type	Numeric type (Real)
Range	200 μ ~ 20m
Preset Value	10.1m
Unit	A
Resolution	10 μ

Query Response

{ numeric } <newline> < ^END >

Examples

```
Dim Var as Double
Var= 0.001
Ana.WriteString ":SOUR1:CURR:CENT " & Str(Var), True
Ana.WriteString ":SOUR1:CURR:CENT?", True
Var=Ana.ReadNumber
```

Related Commands

[:SOUR:CURR:SPAN](#)

[:SOUR:MODE](#)

Equivalent Softkey

Center (in OSC level sweep)

COM Command Syntax (Internal Control Only)

SCPI.SOURCE(Ch).CURRENT.CENTER

:SOUR<Ch>:CURR:SPAN

Type

Command/Query

Syntax

:SOURce<Ch>:CURRent:SPAN <Value>

:SOURce<Ch>:CURRent:SPAN?

Description

This command sets/gets the span of current value in OSC level sweep.

Variable

Parameter	Value
Description	Span value
Data Type	Numeric type (Real)
Range	0 ~ 19.8m
Preset Value	19.8m
Unit	A
Resolution	20 μ

Query Response

{ numeric } < newline > < ^END >

Examples

```
Dim Var as Double
Var= 0.01
Ana.WriteString ":SOUR1:CURR:SPAN " & Str(Var), True
Ana.WriteString ":SOUR1:CURR:SPAN?", True
Var=Ana.ReadNumber
```

Related Commands

[:SOUR:CURR:CENT](#)

[:SOUR:MODE](#)

Equivalent Softkey

Span (in OSC level sweep)

COM Command Syntax (Internal Control Only)

SCPI.SOURCE(Ch).CURRENT.SPAN

:SOUR<Ch>:CURR:STAR

Type

Command/Query

Syntax

:SOURce<Ch>:CURRent:STARt <Value>

:SOURce<Ch>:CURRent:STARt?

Description

This command sets/gets the start of current value in OSC level sweep.

Variable

E4990A Impedance Analyzer Help

Parameter	Value
Description	Start value
Data Type	Numeric type (Real)
Range	200 μ ~ 20m
Preset Value	200 μ
Unit	A
Resolution	20 μ

Query Response

{ numeric } <newline> < ^END >

Examples

```
Dim Var as Double
Var= 0.001
Ana.WriteString ":SOUR1:CURR:STAR " & Str(Var), True
Ana.WriteString ":SOUR1:CURR:STAR?", True
Var=Ana.ReadNumber
```

Related Commands

[:SOUR:CURR:STOP](#)

[:SOUR:MODE](#)

Equivalent Softkey

Start (in OSC level sweep)

COM Command Syntax (Internal Control Only)

SCPI.SOURCE(Ch).CURRENT.START

:SOUR<Ch>:CURR:STOP

Type

Command/Query

Syntax

:SOURce<Ch>:CURRent:STOP <Value>

:SOURce<Ch>:CURRent:STOP?

Description

This command sets/gets the stop of current value in OSC level sweep.

Variable

Parameter	Value
Description	Stop value
Data Type	Numeric type (Real)
Range	200 μ ~ 20m
Preset Value	20m
Unit	A
Resolution	20 μ

Query Response

{ numeric } <newline> < ^END >

Examples

```
Dim Var as Double
Var= 0.01
Ana.WriteString ":SOUR1:CURR:STOP " & Str(Var), True
Ana.WriteString ":SOUR1:CURR:STOP?", True
Var=Ana.ReadNumber
```

Related Commands

[:SOUR:CURR:STAR](#)

[:SOUR:MODE](#)

Equivalent Softkey

Stop (in OSC level sweep)

COM Command Syntax (Internal Control Only)

SCPI.SOURCE(Ch).CURRENT.STOP

:SOUR<Ch>:MODE

Type

Command/Query

Syntax

:SOURce<Ch>:MODE {VOLTage|CURRent}

:SOURce<Ch>:MODE?

Description

This command sets/gets the unit for OSC level.

Variable

E4990A Impedance Analyzer Help

Parameter	Selection Option
Description	OSC unit
Data Type	Character string type (String)
Range	VOLTage CURRent
Preset Value	VOLTage

Query Response

{VOLT|CURR}<newline><^END>

Examples

```
Dim Var as String
Var= "VOLT"
Ana.WriteString ":SOUR1:MODE " & Var, True
Ana.WriteString ":SOUR1:MODE?", True
Var=Ana.ReadString
```

Related Commands

[:SOUR:VOLT](#)

[:SOUR:CURR](#)

Equivalent Softkey

Sweep Setup > **OSC Level** > **OSC Unit**

COM Command Syntax (Internal Control Only)

SCPI.SOURCE(Ch).MODE

:SOUR<Ch>:VOLT

Type

Command/Query

Syntax

:SOURce<Ch>:VOLTage[:LEVel][:IMMediate][:AMPLitude] <Value>

:SOURce<Ch>:VOLTage[:LEVel][:IMMediate][:AMPLitude]?

Description

This command sets/gets the source voltage level.

Variable

Parameter	Value
Description	Voltage level

Data Type	Numeric type (Real)
Range	5m ~ 1
Preset Value	500m
Unit	V
Resolution	1m

Query Response

```
{ numeric } <newline> < ^END >
```

Examples

```
Dim Var as Double
Var= 0.005
Ana.WriteString ":SOUR1:VOLT " & Str(Var), True
Ana.WriteString ":SOUR1:VOLT?", True
Var=Ana.ReadNumber
```

Related Commands

[:SOUR:MODE](#)

Equivalent Softkey

Sweep Setup > **OSC Level** > **Voltage Level**

COM Command Syntax (Internal Control Only)

```
SCPI.SOURCE(Ch).VOLTAGE.LEVEL.IMMEDIATE.AMPLITUDE
```

```
:SOUR<Ch>:VOLT:CENT
```

Type

Command/Query

Syntax

```
:SOURce<Ch>:VOLTage:CENTer <Value>
```

```
:SOURce<Ch>:VOLTage:CENTer?
```

Description

This command sets/gets the center of voltage value in OSC level sweep.

Variable

Parameter	Value
Description	Center value

E4990A Impedance Analyzer Help

Data Type	Numeric type (Real)
Range	5m ~ 1
Preset Value	502.5m
Unit	V
Resolution	500μ

Query Response

{ numeric } <newline> < ^END >

Examples

```
Dim Var as Double
Var= 0.01
Ana.WriteString ":SOUR1:VOLT:CENT " & Str(Var), True
Ana.WriteString ":SOUR1:VOLT:CENT?", True
Var=Ana.ReadNumber
```

Related Commands

[:SOUR:VOLT:SPAN](#)

[:SOUR:MODE](#)

Equivalent Softkey

Center (in OSC level voltage sweep)

COM Command Syntax (Internal Control Only)

SCPI.SOURCE(Ch).VOLTAGE.CENTER

:SOUR<Ch>:VOLT:SPAN

Type

Command/Query

Syntax

:SOURce<Ch>:VOLTage:SPAN <Value>

:SOURce<Ch>:VOLTage:SPAN?

Description

This command sets/gets the span of voltage value in OSC level sweep.

Variable

Parameter	Value
Description	Span value

Data Type	Numeric type (Real)
Range	0 ~ 995m
Preset Value	995m
Unit	V
Resolution	1m

Query Response

```
{ numeric } <newline> < ^END >
```

Examples

```
Dim Var as Double
Var= 0.1
Ana.WriteString ":SOUR1:VOLT:SPAN " & Str(Var), True
Ana.WriteString ":SOUR1:VOLT:SPAN?", True
Var=Ana.ReadNumber
```

Related Commands

[:SOUR:VOLT:CENT](#)

[:SOUR:MODE](#)

Equivalent Softkey

Span (in OSC level voltage sweep)

COM Command Syntax (Internal Control Only)

```
SCPI.SOURCE(Ch).VOLTAGE.SPAN
```

:SOUR<Ch>:VOLT:STAR

Type

Command/Query

Syntax

```
:SOURce<Ch>:VOLTage:STARt <Value>
```

```
:SOURce<Ch>:VOLTage:STARt?
```

Description

This command sets/gets the start of voltage value in OSC level sweep.

Variable

Parameter	Value
Description	Start value

E4990A Impedance Analyzer Help

Data Type	Numeric type (Real)
Range	5m ~ 1
Preset Value	5m
Unit	V
Resolution	1m

Query Response

{ numeric } <newline> < ^END >

Examples

```
Dim Var as Double
Var= 0.005
Ana.WriteString ":SOUR1:VOLT:STAR " & Str(Var), True
Ana.WriteString ":SOUR1:VOLT:STAR?", True
Var=Ana.ReadNumber
```

Related Commands

[:SOUR:VOLT:STOP](#)

[:SOUR:MODE](#)

Equivalent Softkey

Start (in OSC level voltage sweep)

COM Command Syntax (Internal Control Only)

SCPI.SOURCE(Ch).VOLTAGE.START

:SOUR<Ch>:VOLT:STOP

Type

Command/Query

Syntax

:SOURce<Ch>:VOLTage:STOP <Value>

:SOURce<Ch>:VOLTage:STOP?

Description

This command sets/gets the stop of voltage value in OSC level sweep.

Variable

Parameter	Value
Description	Stop value

Data Type	Numeric type (Real)
Range	5m ~ 1
Preset Value	1
Unit	V
Resolution	1m

Query Response

```
{ numeric } <newline> < ^END >
```

Examples

```
Dim Var as Double
Var= 1
Ana.WriteString ":SOUR1:VOLT:STOP " & Str(Var), True
Ana.WriteString ":SOUR1:VOLT:STOP?", True
Var=Ana.ReadNumber
```

Related Commands

[:SOUR:VOLT:STAR](#)

[:SOUR:MODE](#)

Equivalent Softkey

Stop (in OSC level voltage sweep)

COM Command Syntax (Internal Control Only)

```
SCPI.SOURCE(Ch).VOLTAGE.STOP
```

STATUS

:STAT:OPER

Type

Query

Syntax

```
:STATus:OPERation[:EVENT]?
```

Description

This command gets operation status event register.

Query Response

```
{ Numeric } <newline> < ^END >
```

Examples

E4990A Impedance Analyzer Help

```
Dim Var as Long
Ana.WriteString ":STAT:OPER?", True
Var=Ana.ReadNumber
```

Related Commands

[*CLS](#)

[:STAT:OPER:NTR](#)

[:STAT:OPER:PTR](#)

See [Status Register](#)

Equivalent Softkey

No equivalent key is available on the front panel.

COM Command Syntax (Internal Control Only)

SCPI.STATUS.OPERATION.EVENT

:STAT:OPER:COND

Type

Query

Syntax

:STATus:OPERation:CONDition?

Description

This command reads the value of the [Operation Status Condition Register](#).

Variable

Parameter	Value
Description	Value of the Operation Status Condition Register
Data Type	Long integer type (Long)

Query Response

{ numeric } < newline > < ^END >

Examples

```
Dim Var as Long
Ana.WriteString ":STAT:OPER:COND?", True
Var=Ana.ReadNumber
```

Related Commands

[:STAT:OPER:NTR](#)

[:STAT:OPER:PTR](#)

See [Status Register](#)

Equivalent Softkey

No equivalent key is available on the front panel.

COM Command Syntax (Internal Control Only)

SCPI.STATUS.OPERATION.CONDITION

:STAT:OPER:ENAB

Type

Command/Query

Syntax

:STATus:OPERation:ENABle <Value>

:STATus:OPERation:ENABle?

Description

This command sets/gets the value of Operation Status Enable Register.

NOTE

1.

The bit 0 to 3, and bit 6 to 15 cannot be set to

Variable

Parameter	Value
Description	Value of the Operation Status Enable Register
Data Type	Numeric type (Integer)
Range	0 to 65535
Preset Value	0

Query Response

{numeric} <newline> < ^END>

Examples

```
Dim Var as Long
Var= 1
Ana.WriteString ":STAT:OPER:ENAB " & Str(Var), True
Ana.WriteString ":STAT:OPER:ENAB?", True
Var=Ana.ReadNumber
```

Related Commands

[*SRE](#)

[:STAT:OPER:NTR](#)

[:STAT:OPER:PTR](#)

E4990A Impedance Analyzer Help

See [Status Register](#)

Equivalent Softkey

No equivalent key is available on the front panel.

COM Command Syntax (Internal Control Only)

SCPI.STATUS.OPERATION.ENABLE

:STAT:OPER:NTR

Type

Command/Query

Syntax

:STATus:OPERation:NTRansition <Value>

:STATus:OPERation:NTRansition?

Description

This command sets/gets the value of negative transition filter of the [Operation Status Register](#).

NOTE

The bit 0 to 3, and bit 6 to 15 cannot be set to 1.

Variable

Parameter	Value
Description	Value of the negative transition filter
Data Type	Numeric type (Integer)
Range	0 to 65535
Preset Value	0

Query Response

{numeric} <newline> < ^END>

Examples

```
Dim Var as Long
Var= 0
Ana.WriteString ":STAT:OPER:NTR " & Str(Var), True
Ana.WriteString ":STAT:OPER:NTR?", True
Var=Ana.ReadNumber
```

Related Commands

[:STAT:OPER](#)

[:STAT:OPER:PTR](#)See [Status Register](#)**Equivalent Softkey**

No equivalent key is available on the front panel.

COM Command Syntax (Internal Control Only)

SCPI.STATUS.OPERATION.NTRANSITION

:STAT:OPER:PTR**Type**

Command/Query

Syntax

:STATus:OPERation:PTRansition <Value>

:STATus:OPERation:PTRansition?

Description

This command sets/gets the value of positive transition filter of the [Operation Status Register](#).

NOTE

The bit 0 to 3, and bit 6 to 15 cannot be set to 1.

Variable

Parameter	Value
Description	Value of the positive transition filter
Data Type	Numeric type (Integer)
Range	0 to 65535
Preset Value	48

Query Response

{ numeric } <newline> < ^END >

Examples

```
Dim Var as Long
Var= 0
Ana.WriteString ":STAT:OPER:PTR" & Str(Var), True
Ana.WriteString ":STAT:OPER:PTR?", True
Var=Ana.ReadNumber
```

Related Commands

[:STAT:OPER](#)

[:STAT:OPER:NTR](#)

See [Status Register](#)

Equivalent Softkey

No equivalent key is available on the front panel.

COM Command Syntax (Internal Control Only)

SCPI.STATUS.OPERATION.PTRANSITION

:STAT:PRES

Type

Command

Syntax

:STATus:PRESet

Description

This command initializes all the status registers.

Examples

Ana.WriteString ":STAT:PRE", True

Equivalent Softkey

No equivalent key is available on the front panel.

COM Command Syntax (Internal Control Only)

SCPI.STATUS.PRESET

:STAT:QUES

Type

Query

Syntax

:STATus:QUESTionable[:EVENT]?

Description

This command reads the value of the Questionable Status Event Register.

Variable

Parameter	Value
Description	Value of the Questionable Status Event Register
Data Type	Long integer type (Long)

Query Response

{ numeric } <newline> < ^END >

Examples

```
Dim Var as Long
Ana.WriteString ":STAT:QUES?", True
Var=Ana.ReadNumber
```

Related Commands

[*CLS](#)

[:STAT:OPER:NTR](#)

[:STAT:OPER:PTR](#)

See [Status Register](#)

Equivalent Softkey

No equivalent key is available on the front panel.

COM Command Syntax (Internal Control Only)

SCPI.STATUS.QUESTIONABLE.EVENT

:STAT:QUES:COND**Type**

Query

Syntax

:STATus:QUEStionable:CONDition?

Description

This command reads the value of the Questionable Status Condition Register.

Variable

Parameter	Value
Description	Value of the Questionable Status Condition Register
Data Type	Long integer type (Long)

Query Response

{numeric} <newline> < ^END >

Examples

```
Dim Var as Long
Ana.WriteString ":STAT:QUES:COND?", True
Var=Ana.ReadNumber
```

Related Commands

[:STAT:QUES:NTR](#)

[:STAT:QUES:PTR](#)

See [Status Register](#)

Equivalent Softkey

No equivalent key is available on the front panel.

COM Command Syntax (Internal Control Only)

SCPI.STATUS.QUESTIONABLE.CONDITION

:STAT:QUES:ENAB

Type

Command/Query

Syntax

:STATus:QUESTionable:ENABLE <Value>

:STATus:QUESTionable:ENABLE?

Description

This command sets/gets the value of the Questionable Status Enable Register.

NOTE

The bit 0 to 9 and bit 11 to 15 cannot be set to 1.

Variable

Parameter	Value
Description	Value of the Questionable Status Enable Register
Data Type	Numeric type (Integer)
Range	0 to 65535
Preset Value	0

Query Response

{ numeric } <newline> < ^END >

Examples

```
Dim Var as Long
Var= 0
Ana.WriteString ":STAT:QUES:ENAB" & Str(Var), True
Ana.WriteString ":STAT:QUES:ENAB?", True
Var=Ana.ReadNumber
```

Related Commands

[*SRE](#)

See [Status Register](#)

Equivalent Softkey

No equivalent key is available on the front panel.

COM Command Syntax (Internal Control Only)

SCPI.STATUS.QUESTIONABLE.ENABLE

:STAT:QUES:LIM**Type**

Query

Syntax

:STATus:QUEStionable:LIMit[:EVENT]?

Description

This command reads the value of the Questionable Limit Status Event Register.

Variable

Parameter	Value
Description	Value of the Questionable Limit Status Event Register
Data Type	Long integer type (Long)

Query Response

{numeric} <newline> < ^END >

Examples

```
Dim Var as Long
Ana.WriteString ":STAT:QUES:LIM?", True
Var=Ana.ReadNumber
```

Related Commands

[*CLS](#)

Equivalent Softkey

No equivalent key is available on the front panel.

COM Command Syntax (Internal Control Only)

SCPI.STATUS.QUESTIONABLE.LIMIT.EVENT

:STAT:QUES:LIM:CHAN<Ch>**Type**

Query

Syntax

:STATus:QUEStionable:LIMit:CHANnel<Ch>[:EVENT]?

E4990A Impedance Analyzer Help

Description

This command reads the value of the Questionable Limit Channel Status Event Register.

Variable

Parameter	Value
Description	Value of the Questionable Limit Channel Status Event Register
Data Type	Long integer type (Long)

Query Response

```
{numerc} <newline> < ^END>
```

Examples

```
Dim Var as Long  
Ana.WriteString ":STAT:QUES:LIM:CHAN1?", True  
Var=Ana.ReadNumber
```

Related Commands

[*CLS](#)

Equivalent Softkey

No equivalent key is available on the front panel.

COM Command Syntax (Internal Control Only)

```
SCPI.STATUS.QUESTIONABLE.LIMIT.CHANNEL(Ch).EVENT
```

```
:STAT:QUES:LIM:CHAN<Ch>:COND
```

Type

Query

Syntax

```
:STATus:QUESTionable:LIMit:CHANnel<Ch>:CONDition?
```

Description

This command reads the value of the Questionable Limit Channel Status Condition Register.

Variable

Parameter	Value
Description	Value of the Questionable Limit Channel Status Condition Register

Data Type	Long integer type (Long)
------------------	--------------------------

Query Response

{ numeric} <newline> < ^END>

Examples

```
Dim Var as Long
Ana.WriteString ":STAT:QUES:LIM:CHAN1:COND?", True
Var=Ana.ReadNumber
```

Related Commands

[:STAT:QUES:LIM:CHAN:NTR](#)

[:STAT:QUES:LIM:CHAN:PTR](#)

Equivalent Softkey

No equivalent key is available on the front panel.

COM Command Syntax (Internal Control Only)

SCPI.STATUS.QUESTIONABLE.LIMIT.CHANNEL(Ch).CONDITION

:STAT:QUES:LIM:CHAN<Ch>:ENAB

Type

Command/Query

Syntax

:STATus:QUESTionable:LIMit:CHANnel<Ch>:ENABLE <Value>

:STATus:QUESTionable:LIMit:CHANnel<Ch>:ENABLE?

Description

This command sets/gets the value of the Questionable Limit Channel Status Enable Register.

NOTE

The bit 0, and bit 5 to 15 cannot be set to 1.

Variable

Parameter	Value
Description	Value of the Questionable Limit Channel Status Enable Register
Data Type	Numeric type (Integer)
Range	0 to 65535

Preset Value	0
---------------------	---

Query Response

{numeric} <newline> < ^END>

Examples

```
Dim Var as Long
Var= 0
Ana.WriteString ":STAT:QUES:LIM:CHAN1:ENAB " & Str(Var), True
Ana.WriteString ":STAT:QUES:LIM:CHAN1:ENAB?", True
Var=Ana.ReadNumber
```

Related Commands

[:STAT:QUES:LIM:ENAB](#)

Equivalent Softkey

No equivalent key is available on the front panel.

COM Command Syntax (Internal Control Only)

SCPI.STATUS.QUESTIONABLE.LIMIT.CHANNEL(Ch).ENABLE

:STAT:QUES:LIM:CHAN<Ch>:NTR

Type

Command/Query

Syntax

:STATus:QUESTionable:LIMit:CHANnel<Ch>:NTRansition <Value>

:STATus:QUESTionable:LIMit:CHANnel<Ch>:NTRansition?

Description

This command sets/gets the value of the negative transition filter of the Questionable Limit Channel Status Register.

NOTE The bit 0, and bit 5 to 15 cannot be set to 1.

Variable

Parameter	Value
Description	Value of the negative transition filter
Data Type	Numeric type (Integer)
Range	0 to 65535

Preset Value	0
---------------------	---

Query Response

{ numeric} <newline> < ^END>

Examples

```
Dim Var as Long
Var= 0
Ana.WriteString ":STAT:QUES:LIM:CHAN1:NTR " & Str(Var), True
Ana.WriteString ":STAT:QUES:LIM:CHAN1:NTR?", True
Var=Ana.ReadNumber
```

Related Commands

[:STAT:QUES:LIM:CHAN](#)

[:STAT:QUES:LIM:CHAN:PTR](#)

Equivalent Softkey

No equivalent key is available on the front panel.

COM Command Syntax (Internal Control Only)

SCPI.STATUS.QUESTIONABLE.LIMIT.CHANNEL(Ch).NTRANSITION

:STAT:QUES:LIM:CHAN<Ch>:PTR

Type

Command/Query

Syntax

:STATus:QUESTionable:LIMit:CHANnel<Ch>:PTRansition <Value>

:STATus:QUESTionable:LIMit:CHANnel<Ch>:PTRansition?

Description

This command sets/gets the value of the positive transition filter of the Questionable Limit Channel Status Register .

NOTE

The bit 0, and bit 5 to 15 cannot be set to 1.

Variable

Parameter	Value
Description	Value of the positive transition filter
Data Type	Numeric type (Integer)
Range	0 to 65535

E4990A Impedance Analyzer Help

Preset Value	30
---------------------	----

Query Response

{numeric} <newline> < ^END>

Examples

```
Dim Var as Long
Var= 0
Ana.WriteString ":STAT:QUES:LIM:CHAN1:PTR " & Str(Var), True
Ana.WriteString ":STAT:QUES:LIM:CHAN1:PTR?", True
Var=Ana.ReadNumber
```

Related Commands

[:STAT:QUES:LIM:CHAN](#)

[:STAT:QUES:LIM:CHAN:NTR](#)

Equivalent Softkey

No equivalent key is available on the front panel.

COM Command Syntax (Internal Control Only)

SCPI.STATUS.QUESTIONABLE.LIMIT.CHANNEL(Ch).PTRANSITION

:STAT:QUES:LIM:COND

Type

Query

Syntax

:STATus:QUESTIONable:LIMit:CONDition?

Description

This command reads the value of the Questionable Limit Status Condition Register.

Variable

Parameter	Value
Description	Value of the Questionable Limit Status Condition Register
Data Type	Long integer type (Long)

Query Response

{numeric} <newline> < ^END>

Examples

```
Dim Var as Long
Ana.WriteString ":STAT:QUES:LIM:COND?", True
Var=Ana.ReadNumber
```

Related Commands

[:STAT:QUES:LIM:CHAN:NTR](#)

[:STAT:QUES:LIM:CHAN:PTR](#)

Equivalent Softkey

No equivalent key is available on the front panel.

COM Command Syntax (Internal Control Only)

SCPI.STATUS.QUESTIONABLE.LIMIT.CONDITION

:STAT:QUES:LIM:ENAB

Type

Command/Query

Syntax

:STATus:QUEStionable:LIMit:ENABle <Value>

:STATus:QUEStionable:LIMit:ENABle?

Description

This command sets/gets the value of the Questionable Limit Status Enable Register.

NOTE

The bit 0, and bit 5 to 15 cannot be set to 1.

Variable

Parameter	Value
Description	Value of the Questionable Limit Status Enable Register
Data Type	Numeric type (Integer)
Range	0 to 65535
Preset Value	0

Query Response

{numeric} <newline> <^END>

Examples

E4990A Impedance Analyzer Help

```
Dim Var as Long
Var= 0
Ana.WriteString ":STAT:QUES:LIM:ENAB" & Str(Var), True
Ana.WriteString ":STAT:QUES:LIM:ENAB?", True
Var=Ana.ReadNumber
```

Related Commands

[:STAT:QUES:ENAB](#)

Equivalent Softkey

No equivalent key is available on the front panel.

COM Command Syntax (Internal Control Only)

```
SCPI.STATUS.QUESTIONABLE.LIMIT.ENABLE
```

:STAT:QUES:LIM:NTR

Type

Command/Query

Syntax

```
:STATus:QUESTionable:LIMit:NTRansition <Value>
```

```
:STATus:QUESTionable:LIMit:NTRansition?
```

Description

This command sets/gets the value of the negative transition filter of the Questionable Limit Status Register.

NOTE

The bit 0, and bit 5 to 15 cannot be set to 1.

Variable

Parameter	Value
Description	Value of the negative transition filter
Data Type	Numeric type (Integer)
Range	0 to 65535
Preset Value	0

Query Response

```
{numeric} <newline> < ^END >
```

Examples

```
Dim Var as Long
Var= 0
```

```
Ana.WriteString ":STAT:QUES:LIM:NTR " & Str(Var), True
Ana.WriteString ":STAT:QUES:LIM:NTR?", True
Var=Ana.ReadNumber
```

Related Commands

[:STAT:QUES:LIM](#)

[:STAT:QUES:LIM:PTR](#)

Equivalent Softkey

No equivalent key is available on the front panel.

COM Command Syntax (Internal Control Only)

SCPI.STATUS.QUESTIONABLE.LIMIT.NTRANSITION

:STAT:QUES:LIM:PTR

Type

Command/Query

Syntax

:STATus:QUEStionable:LIMit:PTRansition <Value>

:STATus:QUEStionable:LIMit:PTRansition?

Description

This command sets/gets the value of positive transition filter of the Questionable Limit Status Register.

NOTE

The bit 0, and bit 5 to 15 cannot be set to 1.

Variable

Parameter	Value
Description	Value of the positive transition filter
Data Type	Numeric type (Integer)
Range	0 to 65535
Preset Value	30

Query Response

{ numeric } <newline> < ^END >

Examples

```
Dim Var as Long
Var= 0
Ana.WriteString ":STAT:QUES:LIM:PTR " & Str(Var), True
```

E4990A Impedance Analyzer Help

```
Ana.WriteString ":STAT:QUES:LIM:PTR?", True  
Var=Ana.ReadNumber
```

Related Commands

[:STAT:QUES:LIM](#)

[:STAT:QUES:LIM:NTR](#)

Equivalent Softkey

No equivalent key is available on the front panel.

COM Command Syntax (Internal Control Only)

SCPI.STATUS.QUESTIONABLE.LIMIT.PTRANSITION

:STAT:QUES:NTR

Type

Command/Query

Syntax

:STATus:QUESTionable:NTRansition <Value>

:STATus:QUESTionable:NTRansition?

Description

This command sets/gets the value of negative transition filter of the Questionable Status Register.

NOTE

The bit 0 to 9 and bit 11 to 15 cannot be set to 1.

Variable

Parameter	Value
Description	Value of the negative transition filter
Data Type	Numeric type (Integer)
Range	0 to 65535
Preset Value	0

Query Response

{numeric} <newline> < ^END >

Examples

```
Dim Var as Long  
Var= 0  
Ana.WriteString ":STAT:QUES:NTR " & Str(Var), True
```

```
Ana.WriteString ":STAT:QUES:NTR?", True
Var=Ana.ReadNumber
```

Related Commands

[:STAT:QUES](#)

[:STAT:QUES:PTR](#)

See [Status Register](#)

Equivalent Softkey

No equivalent key is available on the front panel.

COM Command Syntax (Internal Control Only)

SCPI.STATUS.QUESTIONABLE.NTRANSITION

:STAT:QUES:PTR**Type**

Command/Query

Syntax

:STATus:QUESTionable:PTRansition <Value>

:STATus:QUESTionable:PTRansition?

Description

This command sets/gets the value of the positive transition filter of the Questionable Status Register.

NOTE

The bit 0 to 9 and bit 11 to 15 cannot be set to 1.

Variable

Parameter	Value
Description	Value of positive transition filter
Data Type	Numeric type (Integer)
Range	0 to 65535
Preset Value	1024

Query Response

{numeric} <newline> < ^END>

Examples

```
Dim Var as Long
Var= 0
```

E4990A Impedance Analyzer Help

```
Ana.WriteString ":STAT:QUES:PTR " & Str(Var), True  
Ana.WriteString ":STAT:QUES:PTR?", True  
Var=Ana.ReadNumber
```

Related Commands

[:STAT:QUES](#)

[:STAT:QUES:NTR](#)

See [Status Register](#)

Equivalent Softkey

No equivalent key is available on the front panel.

COM Command Syntax (Internal Control Only)

```
SCPI.STATUS.QUESTIONABLE.PTRANSITION
```

SYSTEM

:SYST:ADAP:SET:CLE

Type

Command

Syntax

```
:SYSTem:ADAPter:SETup:CLEar
```

Description

This command clears the adapter setup data of current adapter.

Examples

```
Ana.WriteString ":SYST:ADAP:SET:CLE", True
```

Related Commands

Equivalent Softkey

No equivalent key is available on the front panel.

COM Command Syntax (Internal Control Only)

```
SCPI.SYSTEM.ADAPTER.SETUP.CLEAR
```

:SYST:BACK

Type

Command/Query

Syntax

```
:SYSTem:BACKlight {ON|OFF|1|0}
```

```
:SYSTem:BACKlight?
```

Description

This command turns ON/OFF or return the status of the backlight of the LCD display.

NOTE

When the backlight is OFF, you cannot read the information on the display.

Variable

Parameter	Selection Option
Description	ON/OFF of the backlight
Data Type	Boolean type (Boolean)
Range	ON OFF 1 0
Preset Value	ON

Query Response

```
{1|0} <newline> < ^END >
```

Examples

```
Dim Var as Integer
Ana.WriteString ":SYST:BACK ON", True
Ana.WriteString ":SYST:BACK?", True
Var=Ana.ReadNumber
```

Equivalent Softkey

System > Backlight

COM Command Syntax (Internal Control Only)

```
SCPI.SYSTEM.BACKLIGHT
```

```
:SYST:BEEP:COMP:IMM
```

Type

Command

Syntax

```
:SYSTem:BEEPer:COMPlEte:IMMEdiate
```

Description

This command sounds a beep for the notification of completion.

Examples

```
Ana.WriteString ":SYST:BEEP:COMP:IMM", True
```

Related Commands

[:SYST:BEEP:COMP:STAT](#)

[:SYST:BEEP:WARN:IMM](#)

Equivalent Softkey

System > Misc Setup > Beeper > Test Beep Complete

COM Command Syntax (Internal Control Only)

```
SCPI.SYSTEM.BEEPER.COMPLETE.IMMEDIATE
```

```
:SYST:BEEP:COMP:STAT
```

E4990A Impedance Analyzer Help

Type

Command/Query

Syntax

:SYSTem: BEEPer: COMPlete: STATe {ON|OFF|1|0}

:SYSTem: BEEPer: COMPlete: STATe?

Description

This command turns ON/OFF or returns the status of the beeper for the notification of the completion of the operation.

Variable

Parameter	Selection Option
Description	ON/OFF of the beeper for the notification of the completion of the operation
Data Type	Boolean type (Boolean)
Range	ON OFF 1 0
Preset Value	ON

Query Response

{1|0} <newline> < ^END >

Examples

```
Dim Var as Long
Ana.WriteString ":SYST:BEEP:COMP:STAT ON", True
Ana.WriteString ":SYST:BEEP:COMP:STAT?", True
Var=Ana.ReadNumber
```

Related Commands

[:SYST: BEEP: COMP: IMM](#)

[:SYST: BEEP: WARN: STAT](#)

Equivalent Softkey

System > Misc Setup > Beeper > Beep Complete

COM Command Syntax (Internal Control Only)

SCPI.SYSTEM.BEEPER.COMPLETE.STATE

:SYST:BEEP:WARN:IMM

Type

Command

Syntax

```
:SYSTem:BEEPer:WARNing:IMMEDIATE
```

Description

This command sounds a beep for the notification of warning/limit test results.

Examples

```
Ana.WriteString ":SYST:BEEP:WARN:IMM", True
```

Related Commands

[:SYST:BEEP:WARN:STAT](#)

[:SYST:BEEP:COMP:IMM](#)

Equivalent Softkey

System > Misc Setup > Beeper > Test Beep Warning

COM Command Syntax (Internal Control Only)

```
SCPI.SYSTEM.BEEPER.WARNING.IMMEDIATE
```

```
:SYST:BEEP:WARN:STAT
```

Type

Command/Query

Syntax

```
:SYSTem:BEEPer:WARNing:STATe {ON|OFF|1|0}
```

```
:SYSTem:BEEPer:WARNing:STATe?
```

Description

This command turns ON/OFF or return the status of the beeper for the notification of warning/limit test results.

Variable

Parameter	Selection Option
Description	ON/OFF of the beeper for the notification of warning/limit test result
Data Type	Boolean type (Boolean)
Range	ON OFF 1 0
Preset Value	ON

Query Response

E4990A Impedance Analyzer Help

{1|0} <newline> < ^END>

Examples

```
Dim Var as Long
Ana.WriteString ":SYST:BEEP:WARN:STAT ON", True
Ana.WriteString ":SYST:BEEP:WARN:STAT?", True
Var=Ana.ReadNumber
```

Related Commands

[:SYST:BEEP:WARN:IMM](#)

[:SYST:BEEP:COMP:STAT](#)

Equivalent Softkey

System > **Misc Setup** > **Beeper** > **Beep Warning**

COM Command Syntax (Internal Control Only)

SCPI.SYSTEM.BEEPER.WARNING.STATE

:SYST:COMM:LAN:CONT

Type

Query

Syntax

:SYSTEM:COMMunicate:LAN:CONTROL?

Description

This command gets control port number of socket connection.

Variable

Parameter	Long
Description	Control port number of socket
Data Type	Long integer type (Long)

Query Response

{numeric} <newline> < ^END>

Socket connection control port number

Examples

```
Dim Var as Long
Ana.WriteString ":SYST:COMM:LAN:CONT?", True
Var=Ana.ReadNumber
```

Equivalent Softkey

No equivalent key is available on the front panel.

COM Command Syntax (Internal Control Only)

SCPI.SYSTEM.COMMUNICATE.LAN.CONTROL

:SYST:DATE

Type

Command/Query

Syntax

:SYSTem:DATE <Value1>, <Value2>, <Value3>

:SYSTem:DATE?

Description

This command sets/gets the date of the clock built in the E4990A. When you logged in the E4990A as [standard user](#), an error occurs.

Variable

Parameter	Value1
Description	Year
Data Type	Numeric type (Integer)
Range	2001 ~ 2099
Resolution	1

Parameter	Value2
Description	Month
Data Type	Numeric type (Integer)
Range	1 to 12
Resolution	1

Parameter	Value3
Description	Date

E4990A Impedance Analyzer Help

Data Type	Numeric type (Integer)
Range	1 to 31
Resolution	1

Query Response

```
{ numeric1(year) }, { numeric2(month),  
{ numeric3(date) } <newline> < ^END >
```

Examples

```
Dim Var as Variant  
Ana.WriteString ":SYST:DATE 2013,1,10", True  
Ana.WriteString ":SYST:DATE?", True  
Var=Ana.ReadList
```

Related Commands

[:SYST:TIME](#)

Equivalent Softkey

System > **Misc Setup** > **Clock Setup** > **Set Data and Time...**

COM Command Syntax (Internal Control Only)

```
SCPI.SYSTEM.DATE
```

:SYST:ERR

Type

Query

Syntax

```
:SYSTem:ERRor?
```

Description

This command reads the oldest error from the list of errors stored in the error queue of the E4990A. The read-out error is deleted from the error queue. The size of the error queue is 100.

Executing [*CLS](#) command clears the errors stored in the error queue.

This object can not return an error that occurs by the manual operation or the SCPI command used in controlling the E4990A from the external controller.

Query Response

```
{ numeric (error number) }, { String (error message) } <newline> < ^END >
```

If no error is stored in the error queue, 0 and "No error" are read out as the error number and the error message.

Examples

```
Dim Var As Variant, ErrNo As Long, ErrDesc As String
Ana.WriteString ":SYST:ERR?", True
Var = Ana.ReadList
ErrNo = Var(0)
ErrDesc = Var(1)
```

Related Commands

[*CLS](#)

Equivalent Softkey

No equivalent key is available on the front panel.

COM Command Syntax (Internal Control Only)

SCPI.SYSTEM.ERROR

:SYST:KLOC:KBD

Type

Command/Query

Syntax

:SYSTem:KLOCK:KBD {ON|OFF|1|0}

:SYSTem:KLOCK:KBD?

Description

This command sets/gets whether to lock the operation of the front panel (key and rotary knob) and keyboard.

Variable

Parameter	Selection Option
Description	ON/OFF of lock
Data Type	Boolean type (Boolean)
Range	ON OFF 1 0
Preset Value	OFF

Query Response

{1|0} <newline> <^END>

Examples

```
Dim Var as Integer
Ana.WriteString ":SYST:KLOC:KBD ON", True
```

E4990A Impedance Analyzer Help

```
Ana.WriteString ":SYST:KLOC:KBD?", True  
Var=Ana.ReadNumber
```

Related Commands

[:SYST:KLOC:MOUS](#)

Equivalent Softkey

System > Misc Setup > Key Lock > Front Panel & Keyboard Lock

COM Command Syntax (Internal Control Only)

```
SCPI.SYSTEM.KLOCK.KBD
```

:SYST:KLOC:MOUS

Type

Command/Query

Syntax

```
:SYSTem:KLOCK:MOUSe {ON|OFF|1|0}
```

```
:SYSTem:KLOCK:MOUSe?
```

Description

This command sets/gets whether to lock the operation of the mouse and touch screen.

Variable

Parameter	Selection Option
Description	ON/OFF of lock
Data Type	Boolean type (Boolean)
Range	ON OFF 1 0
Preset Value	OFF

Query Response

```
{1|0} <newline> < ^END >
```

Examples

```
Dim Var as Integer  
Ana.WriteString ":SYST:KLOC:MOUS ON", True  
Ana.WriteString ":SYST:KLOC:MOUS?", True  
Var=Ana.ReadNumber
```

Related Commands

[:SYST:KLOC:KBD](#)

Equivalent Softkey

System > Misc Setup > Key Lock > Touch Screen & Mouse Lock

COM Command Syntax (Internal Control Only)

SCPI.SYSTEM.KLOCK.MOUSE

:SYST:POFF

Type

Command

Syntax

:SYSTEM:POFF

Description

This command turns OFF the E4990A.

Examples

Ana.WriteString ":SYST:POFF", True

Equivalent Softkey

No equivalent key is available on the front panel.

COM Command Syntax (Internal Control Only)

SCPI.SYSTEM.POFF

:SYST:PRES

Type

Command

Syntax

:SYSTEM:PRESet

Description

This command presets the setting state of the E4990A to the original factory setting (Default Conditions). This command is different from [*RST](#) as the continuous startup mode ([:INIT:CONT](#)) of channel 1 is set to ON.

Examples

Ana.WriteString ":SYST:PRES", True

Related Commands

[*RST](#)[:SYST:UPR](#)

Equivalent Softkey

Preset (When **System > Misc Setup > Preset Setup > State > Factory** is selected.)

COM Command Syntax (Internal Control Only)

SCPI.SYSTEM.PRESET

:SYST:SEC

Type

Command/Query

Syntax

E4990A Impedance Analyzer Help

:SYSTem:SECurity[:LEVel] {NONE|LOW|HIGH}

:SYSTem:SECurity[:LEVel]?

Description

This command sets/gets security level for frequency blanking. Once it becomes HIGH, it cannot be changed.

Variable

Parameter	Selection Option
Description	The security level
Data Type	Character string type (String)
Range	NONE LOW HIGH
Preset Value	NONE

Query Response

{NONE|LOW|HIGH} <newline> < ^END>

Examples

```
Dim Var as String
Var= "NONE"
Ana.WriteString ":SYST:SEC " & Var, True
Ana.WriteString ":SYST:SEC?", True
Var=Ana.ReadString
```

Equivalent Softkey

System > **Service Menu** > **Security Level**

COM Command Syntax (Internal Control Only)

SCPI.SYSTEM.SECURITY.LEVEL

:SYST:SERV

Type

Query

Syntax

:SYSTem:SERVice?

Description

This command reads whether the E4990A is in the service mode or not.

Query Response

{1|0} <newline> < ^END>

Examples

```
Dim Var as Long
Ana.WriteString ":SYST:SERV?", True
Var=Ana.ReadNumber
```

Equivalent Softkey

Displayed on the instrument status bar (at the bottom of the LCD display).

COM Command Syntax (Internal Control Only)

```
SCPI.SYSTEM.SERVICE
```

:SYST:SET**Type**

Command

Syntax

```
:SYSTem:SET <Value>
```

Description

This command recalls the state of the instrument when the *LRN? query is executed. The contents to be recalled depends on the contents of the block data.

If the block data contains trace state, the trigger source ([:TRIG:SOUR](#)) becomes "MANual". The result of *LRN? query contains ":SYSTem:SET " prefix. Hence, the *LRN? simply executes this command.

This command requires instrument settings by binary block data (same as Save/Recall state file contents).

Variable

Parameter	Value
Description	Command Setup
Data Type	Binary Type

Examples

```
Dim SETData() As Byte, NoofByte As Double
```

```
**** Recall the State data from the file, State01.sta is a state file saved by E4990A
```

```
Open "C:\State01.sta" For Binary As #1
```

```
    NoofByte = LOF(1)
```

```
    ReDim SETData(NoofByte)
```

```
    Get #1, , SETData()
```

```
Close
```

```
**** Send the State file data to E4990A
```

E4990A Impedance Analyzer Help

Ana.WriteIEEEBlock ":SYST:SET ", SETData, True

Related Commands

[*LRN](#)

Equivalent Softkey

No equivalent key is available on the front panel.

COM Command Syntax (Internal Control Only)

SCPI.SYSTEM.SET

:SYST:TIME

Type

Command/Query

Syntax

:SYSTem:TIME <Value1>, <Value2>, <Value3>

:SYSTem:TIME?

Description

This command sets/gets the time of the clock built in the E4990A. When you logged in the E4990A as [standard user](#), an error occurs.

Variable

Parameter	Value1
Description	hour
Data Type	Numeric type (Integer)
Range	0 to 23
Resolution	1

Parameter	Value2
Description	Minute
Data Type	Numeric type (Integer)
Range	0 to 59
Resolution	1

Parameter	Value3
Description	Second
Data Type	Numeric type (Integer)
Range	0 to 59
Resolution	1

Query Response

```
{ numeric1(hour)}, { numerc2(minute)},
{ numerc3(second)} <newline> < ^END>
```

Examples

```
Dim Var as Variant
Ana.WriteString ":SYST:TIME 10,10, 20", True
Ana.WriteString ":SYST:TIME?", True
Var=Ana.ReadList
```

Related Commands

[:SYST:DATE](#)

Equivalent Softkey

System > Misc Setup > Clock Setup > Set Data and Time...

COM Command Syntax (Internal Control Only)

```
SCPI.SYSTEM.TIME
```

:SYST:UPR**Type**

Command

Syntax

```
:SYSTem:UPReset
```

Description

This command presets the E4990A with the user settings. The command is executed regardless of the operation mode in preset state.

If you try to specify a file for a preset (D:\UserPreset.sta) that does not exist, a warning message will be displayed and [:SYST:PRES](#) will be executed.

Examples

```
Ana.WriteString ":SYST:UPR", True
```

Related Commands

[*RST](#)

[:SYST:PRES](#)

Equivalent Softkey

Preset (When **System** > **Misc Setup** > **Preset Setup** > **State** > **User** is selected.)

COM Command Syntax (Internal Control Only)

SCPI.SYSTEM.UPRESET

TRIGGER

:TRIG:AVER

Type

Command/Query

Syntax

:TRIGger[:SEQuence]:AVERage {ON|OFF|1|0}

:TRIGger[:SEQuence]:AVERage?

Description

This command turns ON/OFF or gets the status of the averaging trigger function.

NOTE

The sweep averaging feature must be set to ON when turning on the averaging trigger feature.

Variable

Parameter	Selection Option
Description	ON/OFF status of the averaging trigger
Data Type	Boolean type (Boolean)
Range	ON OFF 1 0
Preset Value	OFF

Query Response

{1|0} <newline> < ^END >

Examples

Dim Var as Boolean

Var= 1

Ana.WriteString ":TRIG:AVER " & Str(Var), True

```
Ana.WriteString ":TRIG:AVER?", True
Var=Ana.ReadNumber
```

Related Commands

[:TRIG](#)

Equivalent Softkey

Average > **Avg Trigger**

COM Command Syntax (Internal Control Only)

```
SCPI.TRIGGER.SEQUENCE.AVERAGE
```

:TRIG

Type

Command

Syntax

```
:TRIGger[:SEQuence][:IMMediate]
```

Description

This command generates a trigger immediately and executes a measurement, regardless of the setting of the trigger mode.

This command is different from [:TRIG:SING](#) as the execution of the object finishes at the time of a trigger.

NOTE

If you execute this object when the trigger system is not in the trigger wait state (trigger event detection state), an error occurs when executed and the object is ignored.

Examples

```
Ana.WriteString ":TRIG", True
```

Related Commands

[:TRIG:SOUR](#)

[:TRIG:SING](#)

[*TRG](#)

Equivalent Softkey

Trigger > **Trigger** (This is for manual trigger.)

COM Command Syntax (Internal Control Only)

```
SCPI.TRIGGER.SEQUENCE.IMMEDIATE
```

:TRIG:POIN

Type

Command/Query

Syntax

```
:TRIGger[:SEQuence]:POINT {ON|OFF|1|0}
```

```
:TRIGger[:SEQuence]:POINT?
```

E4990A Impedance Analyzer Help

Description

This command turns ON/OFF or returns the status of the point trigger feature.

NOTE

When the trigger source is set to the internal trigger (Internal), the setting is ignored.

Variable

Parameter	Selection Option
Description	Turns ON/OFF the point trigger
Data Type	Boolean type (Boolean)
Range	ON OFF 1 0
Preset Value	OFF

Query Response

```
{ 1|0} <newline> < ^END >
```

Examples

```
Dim Var as Boolean
Var= 1
Ana.WriteString ":TRIG:POIN " & Str(Var), True
Ana.WriteString ":TRIG:POIN?", True
Var=Ana.ReadNumber
```

Related Commands

[:TRIG:SOUR](#)

Equivalent Softkey

Trigger > **Trigger Event**

COM Command Syntax (Internal Control Only)

```
SCPI.TRIGGER.SEQUENCE.POINT
```

```
:TRIG:EXT:DEL
```

Type

Command/Query

Syntax

```
:TRIGger[:SEquence]:EXTernal:DELay <Value>
```

```
:TRIGger[:SEquence]:EXTernal:DELay?
```

Description

This command sets/gets the time that it takes from receiving the trigger to starting measurement when the trigger source is external.

Variable

Parameter	Value
Description	External trigger delay time
Data Type	Numeric type (Real)
Range	0 to 10
Preset Value	0
Unit	s
Resolution	10u

Query Response

```
{0 ~ 10}<newline><^END>
```

Examples

```
Dim Var as Double
Var= 0
Ana.WriteString ":TRIG:EXT:DEL" & Str(Var), True
Ana.WriteString ":TRIG:EXT:DEL?", True
Var=Ana.ReadNumber
```

Related Commands

[:TRIG:POIN](#)

Equivalent Softkey

Trigger > **Trigger Delay**

COM Command Syntax (Internal Control Only)

```
SCPI.TRIGGER.SEQUENCE.EXTERNAL.DELAY
```

:TRIG:EXT:SLOP

Type

Command/Query

Syntax

```
:TRIGger[:SEQuence]:EXTernal:SLOPe {POSitive|NEGative}
```

```
:TRIGger[:SEQuence]:EXTernal:SLOPe?
```

Description

E4990A Impedance Analyzer Help

This command sets/gets the polarity of external trigger input.

Variable

Parameter	Selection Option
Description	Polarity of the external input trigger.
Data Type	Character string type (String)
Range	POSitive NEGative
Preset Value	NEGative

Query Response

```
{ POS|NEG} <newline> < ^END >
```

Examples

```
Dim Var as String  
Var= "POSitive"  
Ana.WriteString ":TRIG:EXT:SLOP " & Var, True  
Ana.WriteString ":TRIG:EXT:SLOP?", True  
Var=Ana.ReadString
```

Related Commands

[:TRIG:EXT:DEL](#)

Equivalent Softkey

Trigger > **Ext Trig Input**

COM Command Syntax (Internal Control Only)

```
SCPI.TRIGGER.SEQUENCE.EXTERNAL.SLOPE
```

:TRIG:SOUR

Type

Command/Query

Syntax

```
:TRIGger[:SEQuence]:SOURce { INTernal|EXTernal|MANual|BUS}
```

```
:TRIGger[:SEQuence]:SOURce?
```

Description

This command sets/gets the trigger source from the following 4 types:

- Internal Trigger: Uses the internal trigger to generate continuous triggers automatically.
- External Trigger: Generates a trigger when the trigger signal is inputted externally via the [Ext Trig connector](#) or the handler interface.

- Manual Trigger: Generates a trigger when the key operation of **Trigger** > **Trigger** is executed from the front panel.
- Bus Trigger: Generates a trigger when the [*TRG](#) is executed.

NOTE

When you change the trigger source during sweep, the sweep is aborted.

Variable

Parameter	Selection Option
Description	Trigger source
Data Type	Character string type (String)
Range	INTernal EXTernal MANual BUS
Preset Value	INTernal

Query Response

```
{ INT|EXT|MAN|BUS } <newline> < ^END >
```

Examples

```
Dim Var as String
Var= "BUS"
Ana.WriteString ":TRIG:SOUR " & Var, True
Ana.WriteString ":TRIG:SOUR?", True
Var=Ana.ReadString
```

Related Commands

[:TRIG](#)

[:TRIG:SING](#)

Equivalent Softkey

Trigger > **Trigger Source**

COM Command Syntax (Internal Control Only)

```
SCPI.TRIGGER.SEQUENCE.SOURCE
```

:TRIG:SCOP**Type**

Command/Query

Syntax

```
:TRIGger[:SEQuence]:SCOPE {ALL|ACTIVE}
```

```
:TRIGger[:SEQuence]:SCOPE?
```

Description

E4990A Impedance Analyzer Help

This command sets/gets the effective scope of triggering. When this function is enabled with a value of "ACTIVE", only active channel is triggered. When this function is enabled with a value of "ALL", all channels of the E4990A are triggered.

For example, if TRIGGER.SCOPE value is "ACTIVE" when [:INIT:CONT](#) command is turned ON for all channels, a measurement channel will automatically be changed by switching over the active channel.

Variable

Parameter	Selection Option
Description	Trigger source
Data Type	Character string type (String)
Range	ALL ACTIVE
Preset Value	ALL
Unit	-
Resolution	-

Query Response

```
{ALL|ACT}<newline><^END>
```

Examples

```
Dim Var as String
Var= "ALL"
Ana.WriteString ":TRIG:SCOP" & Var, True
Ana.WriteString ":TRIG:SCOP?", True
Var=Ana.ReadString
```

Equivalent Softkey

Trigger > **Trigger Scope**

COM Command Syntax (Internal Control Only)

```
SCPI.TRIGGER.SEQUENCE.SCOPE
```

```
:TRIG:SING
```

Type

Command

Syntax

```
:TRIGger[:SEquence]:SINGle
```

Description

This command generates a trigger immediately and executes a measurement, regardless of the setting of the trigger mode.

This command is different from [:TRIG](#) as the execution of the object finishes when the measurement (all of the sweep) initiated with this object is complete. In other words, you can wait for the end of the measurement using the [*OPC](#) object.

If you execute this object when the trigger system is not in the trigger wait state (trigger event detection state), an error occurs when executed and the object is ignored.

Examples

```
Dim Var as Integer
Ana.WriteString ":TRIG:SOUR BUS", True
Ana.WriteString ":INIT1:CONT ON", True
Ana.WriteString ":TRIG:SING", True
Ana.WriteString "*OPC?", True
Var=Ana.ReadNumber
```

Related Commands

[:TRIG](#)

[*OPC](#)

Equivalent Softkey

No equivalent key is available on the front panel.

COM Command Syntax (Internal Control Only)

```
SCPI.TRIGGER.SEQUENCE.SINGLE
```

Index

- 1**
- 16034E 59
- 16034G 59
- 16034H 59
- 16044A 59
- 16047A 59
- 16047E 59
- 16048G 59, 64
- 16048H 59, 64
- 16065A 59
- 16089A 59
- 16089B 59
- 16089C 59
- 16089D 59
- 16089E 59
- 16334A 59, 66
- 16451B 59
- 16452A 59
- 2**
- 24 bit I/O port 25, 315
- 4**
- 42941A 59, 63, 70
- 42942A 59, 68
- A**
- active channel 77, 96
- active trace 79
- adapter 55
 - selection 63
 - setting 59
 - setup 68, 70
 - status 38
- analysis 15
- ASCII 289
- auto-scale 47, 128
- averaging status 30
- avg 15
- B**
- byte order 289
- C**
- cal 15
- cartesian coordinates 127
- center 15
- channel max 15
- chip component 55
- colon 269
- complex format 143
- complex parameters 127
- COMPLEX Z-Y 127
- continuous sweep 96
- corrected data arrays 294
- corrected memory arrays 294
- CSV 175, 191
- D**
- data entry bar 35
- data processing flow 294
- dc Bias 90, 133
- display 15, 169
- E**
- ENTRY block 15
- equation editor 169
- equivalent circuit 164
- ethernet port 24

executing print 195
external controller 260
external trigger 26, 94

F

floating-point number format 289
format 15
formatted data array 294
formatted memory arrays 294
frequency characteristics 164
front panel 15

G

GPIB 257, 258

H

hardkeys 15

I

inductor 164
instrument setup 52
integer format 289
invalid key 228

L

LAN 257, 260
lead component 55
limit line 177
limit test 175
line switch 27
linear format 47
logarithmic format 47
LXI 260

M

manual scale 128
marker 15
marker fctn 15
marker function 143

marker position time 164
marker search 15
MAV 333
mean value 167
meas 15
measurement point trigger 94
MKR/ANALYSIS block 15
multi target search 151
multiple peak 155

N

NAVIGATION block 15
NOP 79
number of points 79
numeric keys 15

O

on-screen keyboard 214
oscillator level 90

P

parameters 269
password 212
peak excursion 154
peak search 154
peak-to-peak 167
phase unit 134
phase values 134
point averaging 79
polar format 143
preset 207
printer 195

R

rear panel 24
reference point 144
reference tracking 128

- relaxation time 164
- resistor 164
- resonant impedance 51
- RESPONSE block 15
- RQS 333
- S**
- scale 15
- screen area 28
- search range 152
- search tracking 153
- segment sweep 93
- self-resonance frequency 51
- semicolon 269
- SICL-LAN 260
- softkey menu bar 39
- span 15
- SRQ 329
- standard deviation 167
- standby switch 15
- start 15
- states 281
 - hold 282
 - idle 282
 - initiate 282
 - measurement 282
 - waiting for trigger 282
- STIMULUS block 15
- stimulus data arrays 294
- stop 15
- sweep direction 79
- sweep parameter 79
- sweep range 79
- sweep setup 15
- sweep trigger 94
- sweep type 79
- sweep-to-sweep averaging 79
- T**
- target search 157
- telnet server 260
- test signal level 133
- time delay 79
- touch screen 206
- touchstone 192
- trace bandwidth 160
- TRACE block 15
- trace layout 72
- trace max 15
- trigger 15
- trigger delay 93, 94
- trigger source 93
- U**
- UNKNOWN terminals 15
- upper/lower case 269
- USB 257, 266
- USB ports 15
- user preset 189, 207
- V**
- vertical axis 47
- VISA/SICL 266
- W**
- windows displays 135
- Z**
- zero span sweep 79
- zooming aperture 79